

LIMITLESS



GPS Smart Drone +
Obstacle Avoidance



Drone-Clone



xperts ®

You'll quickly learn to fly this drone like a Pro! Don't be intimidated by this instruction manual, because we **PROMISE** it's easier than it looks.... even if you aren't tech savy. We have great demonstration videos on our website located under the drone instructions tab. Head to www.DroneCloneXperts.com to watch now!

*** Please keep in mind our website www.DroneCloneXperts.com has important VIDEO instructions, which show you exactly how to properly, and quickly, set up your LIMITLESS 3™ Drone. The video includes demonstrations of how to properly calibrate the drone as well as perform all the incredible flight features LIMITLESS 3 has to offer!**

Please don't fly until you watch the video. The Instructional Video and other helpful PDF resources can be found under the "DRONE INSTRUCTIONS" tab located in the Main Menu on our website www.DroneCloneXperts.com



14+ AGES

L3



HD Full HD Image transmission
Farther. Faster. Clearer
(Please confirm that the mobile phone used supports 5G WiFi standard)



LIMITLESS 3

GPS Smart Drone

* Please read the manual carefully before flight and keep it for future reference.

table of Contents

Quick Start Guide.....	1
1. Precautions for the installation and use of obstacle avoidance equipment.....	2
2. Precautions for the use of gimbal and camera.....	2
3. Remote control and drone pairing.....	2
4. Geomagnetism correction.....	2
5. UAV gyroscope and gimbal level correction.....	2
6. Airplane mode switching.....	3
7. LOW low gear switch HIGH high gear.....	3
8.Unlock the drone.....	3
9. UAV and remote control battery replacement and charging.....	3
10. Know your remote control APP.....	4
Flight tutorial video.....	5
User Manual.....	6
Disclaimer.....	7
laws and regulations.....	7
Safety Precautions.....	7
Product configuration.....	8
UAV component name.....	8
1. Propeller installation.....	9
2. Aircraft lithium battery.....	9
3. Change Camera Angle.....	10
Remote control component name.....	11
LCD display.....	11
Charging the battery of the remote control.....	11
Pre-flight inspection.....	11
UAV code matching.....	11
Geomagnetic correction function.....	12
UAV gyroscope and gimbal level correction.....	12
Connect to APP (mobile phone needs to support 5G-WiFi signal function).....	12
Remote Control Mode 1 & Mode 2.....	12
Mode switching.....	13
LOW low-speed mode switch to HIGH high-speed mode.....	13
Unlock the drone.....	13
Basic flight.....	14
Flight control method.....	14
One-key takeoff/landing.....	15
Headless mode.....	15
One-key return to home.....	15
Return to home after off signal.....	15
Low battery return.....	15
Photo/Video.....	16
Receiving signal strength indicator.....	16
Basic components.....	16
Don't panic if you encounter problems.....	17
Software Manual.....	17
Software installation instructions.....	17
1. Install the mobile client.....	17
2. Connect to the aircraft WiFi.....	17
3. Recommended model configuration.....	18
APP function introduction: When the drone is in the following environment, the fixed-point hovering effect is not good.....	18
1.1 Introduction to the control interface.....	19
1.2.1 Function description of the control interface.....	19
1.2.2 Function description of control interface.....	19
1.2.3 Description of control interface functions.....	20
* Expansion description.....	20
1.2.4 Function description of control interface.....	20
1.3 Gesture Recognition.....	21
2. Introduction to MV interface.....	21

LIMITLESS 3™ Quick Start Guide

* For details, please refer to the instruction manual & VIDEO at DroneCloneXperts.com

NOTE: Obstacle Avoidance Camera on top of drone is easy to install, but can be difficult to take out. To remove it, make sure to pinch both sides with force and pull upwards. See website Video for Demonstration

1. Precautions for the installation and use of Obstacle Avoidance equipment:

⚠ IMPORTANT Use Note:

A. You can fly WITH or WITHOUT the Obstacle Avoider installed, but NEVER connect the obstacle avoider when the drone is already on. If you decide to use it, ALWAYS install the Obstacle Avoider when the drone is OFF.... otherwise it will damage the obstacle avoidance equipment and affect normal use.

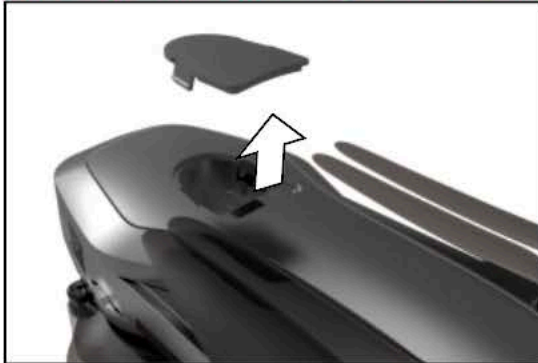

1. To install obstacle avoidance mechanism, first remove cover as shown above (use your fingers or a flathead to pop lid off)

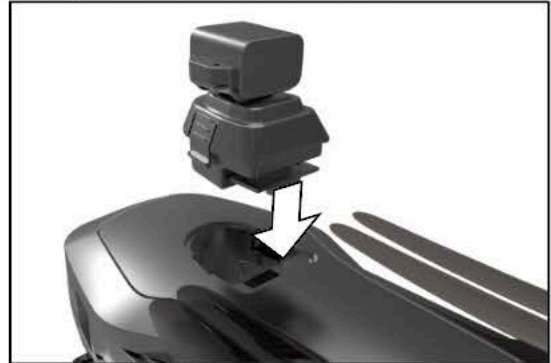

2. Insert the obstacle avoidance equipment as shown in photo above.

B. When turning on this product, **DO NOT touch** the obstacle avoidance equipment, because the obstacle avoidance equipment is in the power-on working state, unauthorized touching will cause the obstacle avoidance equipment to not work normally, and could permanently damage the obstacle avoidance equipment.



The obstacle avoidance equipment will rotate left and right when it is running. **DO NOT** manually interfere with it to prevent it from rotating, otherwise the equipment may become damaged.



C. When removing the obstacle avoidance equipment, the power of the drone **must be turned OFF** before dismantling, otherwise it will damage the obstacle avoidance equipment and affect normal use.

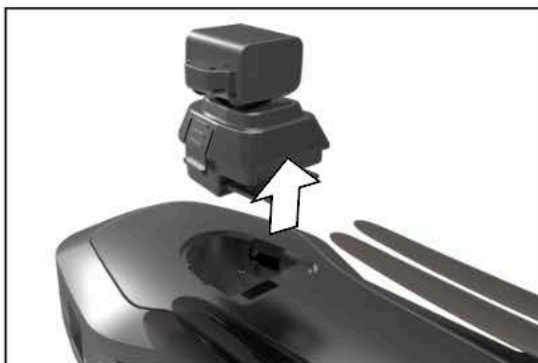

1. Remove obstacle avoidance equipment as shown in the figure. This can be difficult. Make sure to pinch sides in at bottom

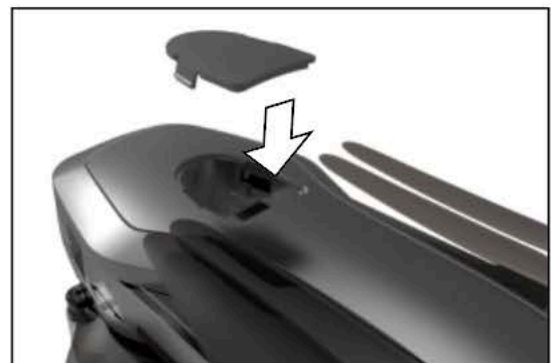

2. Install the cover for the installation position of the obstacle avoidance

2. Precautions for using the PTZ camera:

⚠ IMPORTANT Use Note:

A. Please **REMOVE** the protective cover from the front camera before starting the drone.

B. **DO NOT** touch the gimbal camera when starting this product! The gimbal is automatically calibrated at the moment of power-on, if you touch it without authorization, it will cause the gimbal to fail to calibrate properly, and the gimbal calibration function may be damaged!

***DO NOT** touch the camera while the gimbal is being calibrated or at any time when the power is on!



3. Remote Control Syncing with Drone

Turn on the power of the DRONE first. Then power on the Remote Control. The remote control will automatically synchronize with the drone.

Note: Make sure the drone is placed on flat ground directly in front of the remote control. You'll notice the light of the remote control changes from flashing to solid once the frequency synchronization is successful. If it does not, simply turn both drone and remote off and start again.



⚠ Important Tip:

You must first **CALIBRATE** the drone (watch Instruction Video at DroneCloneXperts.com). This is also known as "correcting the geomagnetism and then the gyroscope", otherwise it will affect the normal use.

4. Geomagnetic correction **(Please watch video for quick & easy demonstration)**

Place drone on a horizontal surface while power is ON. **Press and Hold** button (Figure 1) for 5 seconds to perform geomagnetic correction. At this time, the aircraft lights flash quickly. Pick up the drone and (Figure 2) rotate horizontally 3-5x clockwise (see our instructional video for quick & easy demonstration). Don't stop rotating until you hear a beep. Once beep sounds, then hold drone with camera facing the ground (Figure 3) and rotate 3-5x clockwise. The remote control emits a beep when finished and the drone lights flash slowly. Geomagnetic correction is now complete! This can be hard to mimic from text instructions, so we encourage users to watch our demo video!



5. Drone gyroscope and gimbal level calibration

Place the drone on a horizontal surface. Then **press and hold** button on top-left of remote control for 5 seconds (seen in photo on right) until you hear a beep. The drone lights change from fast flashing to slow flashing.



Long press* this key for 5 seconds



6. Flight mode switch (Notes in Red are VERY IMPORTANT here)

GPS mode is mode 2 and is the default mode. It takes a few mins for drone to get a strong GPS signal. The drone will ONLY take flight once its signal reaches 8 satellites or more. Prior to drone reaching 8 satellites, the drone can unlock the motor but CANNOT take off. To take off, you need to wait until the GPS signal is strong enough. Alternatively, you can switch to Mode 1 (optical flow mode) before the satellite positioning is complete, but this is NOT recommended since the drone won't have GPS and won't return home if signal is lost in mode 1. If you wish to enter Mode 1, press the record button for 5 seconds (photo shown on right). After the switch is successful, the remote control will emit a beep. **At this time, the drone will not have all GPS-related functions (1-click return, low-power return, lost signal return, etc.) Pay attention to height/distance to avoid losing drone!**

Note * It is not possible to switch to optical flow mode after GPS positioning is completed. To switch, you need to turn off the drone and remote control and restart. The opposite scenario is also true, so you'll have to reboot in order to switch back..



Long press this key for 5 seconds (only if attempting to fly in Mode 1).

NOTE: Return to Home WON'T work in Mode 1

7. LOW gear switch HIGH high gear

Note: The product is turned on by default in LOW low-speed gear mode, and the drone has forward obstacle avoidance function. If you switch to HIGH high-speed gear mode, the forward obstacle avoidance function of the drone will automatically fail. At this time, the drone will not have all obstacle avoidance functions. .

Need to pay attention to the flight height and distance, pay attention to the surrounding flying environment, to avoid damage to the drone due to improper flight.

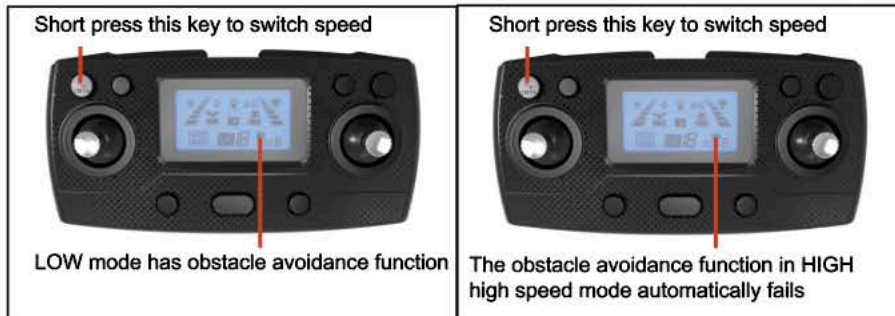

8. Drone unlock

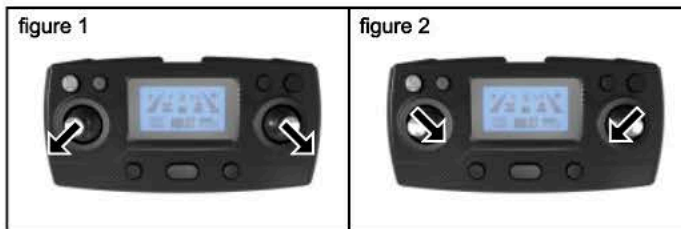

At this time, the throttle stick and the directional stick are pushed to the lower left corner and the lower right corner at the same time (Figure 1), or pushed to the lower right corner and the lower left corner (Figure 2) at the same time, the unlocking can be completed, and the motor can fly after starting.

9. UAV and remote control battery charging

How to take out the drone battery

Press the battery latch and remove the battery backwards. Keep fingers and machine clean and dry before operation, otherwise the battery may become difficult to remove.



Remote control and drone battery charging



⚠ Tips:



- Insert the plug in the correct way.
- It is recommended to use 5V 1-2A adapter for charging.

10. Mobile Phone APP: HFun Pro

(1) Scan the QR code to download & install the **HFun Pro APP**, or simply go to your phone's app store (Supports all smartphones using iOS, Android, or GOOGLE).



IOS
Iphone/Ipad



Android / Google
(USA)

Connect Drone WiFi

1. Power on the drone
2. Go to your smartphone's WiFi settings and find the network that says **XL-PRO-5G-**** or similar
3. Click that network to connect to the Drone's WiFi and then open the HFun Pro App to Prepare for Flight.



Note: If you need to use the mobile APP to control the aircraft directly, you need to turn off the remote control before using it. The mobile phone is connected to the "XL-PRO-5G-*** {Serial Number}" network and connected, and then you can open the mobile APP use

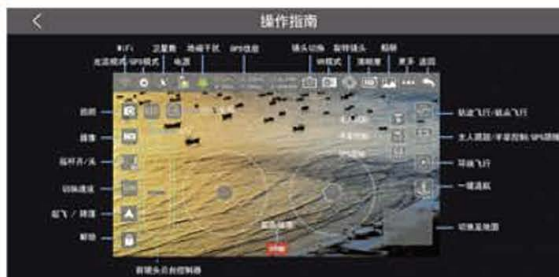

LIMITLESS 3 Flight Tutorial Video

Mode 2 is GPS mode and is the default mode upon startup. It takes about 2-5 mins to acquire a strong GPS Satellite signal (quantity of over 10 satellites). You must be outdoors in an open area to get a strong signal. Stay AWAY from high-voltage wires and other signal interference.

Mode1 is Optical flow mode. When using this mode, you must turn off the GPS function before taking off. See Manual to learn how to exit Mode 2; HOWEVER, please remember Return to Home Failsafes only work in MODE 2 (GPS Mode).



Open camera on phone and focus on code without taking photo. Click on Pop-up.

Mode1: Optical flow mode, suitable for open indoors. After the drone and remote control are aligned, and the geomagnetism and gyroscope are corrected, the display on the remote control changes from Mode0 to Mode1. At this time, the drone will automatically perform GPS satellite positioning. The automatic protection program will not be able to take off, you need to press and hold the video button for 5 seconds, the remote control will make a "drop", which means that the GPS can be unlocked after taking off.

(Note: Mode1 optical flow mode does not have a series of GPS functions such as low-power return, one-click return, etc. Please pay attention to the flight distance and altitude when using)



Press and hold the video button for 5 seconds, the remote control will make a "drop", indicating that the GPS function is turned off

Mode2: GPS / optical flow dual mode, suitable for outdoor open areas without signal interference. After the drone and remote control are linked, the geomagnetic and gyroscopes are corrected, the display on the remote control changes from Mode0 to Mode1, at this time the drone GPS satellite search and positioning automatically (Drone search should be placed in an open area when searching for satellites, and there should be no obstructions such as high-rise buildings or cars, high-voltage power lines, or the drone will not be able to complete GPS satellite search and positioning), etc. The number reaches about 10, the positioning is completed, the remote control emits a "dip", and the display frequency of the remote control changes from Mode1 to Mode2 to indicate that the positioning is successful, and the takeoff can be unlocked. (Note: GPS mode does not complete GPS

Before positioning, the drone automatically enables the protection program and cannot take off)

Drone-Clone perts®

LIMITLESS 3

User manual



HD Full HD Image transmission
Farther. Faster. Clearer
(Please confirm that the mobile phone used supports 5G WiFi standard)

GPS



Foldable



GPS
Return Home



Point of
Interest



Way Point
Flight



Intelligent
APP Following



Automatic
obstacle
avoidance



Ultra HD
Aerial
Photograph



3-axis
anti-shake
and
self-stabilizing
gimbal



EIS electronic
image
stabilization



Optical flow
positioning

Important notices and safety guidelines

You are welcome to purchase our products. In order to make it easier and more convenient for you to use this drone, please read this manual carefully before operating, and please keep this manual in a safe place for future reference for adjustment and maintenance.

Disclaimer

- This product is not a toy, but a precision device that integrates mechanical, electronic, aerodynamics, high-frequency emission and other professional knowledge into one. It requires correct assembly and debugging to avoid accidents. The product owner must use a safe method to operate the control; improper operation may cause serious personal injury or property damage.
- This product is suitable for people who have experience in operating model drones and are not less than 14 years old.
- If you have any questions about use, operation, maintenance, etc., please contact your local dealer or our company. Our company and the seller are not responsible for any loss and damage caused by improper use or operation and human injury.
- The product contains small parts. Keep it out of the reach of children to avoid the danger of accidental eating or suffocation.

Laws and regulations

To avoid possible injury and loss from illegal activities, the following items must be observed:

- Never fly near a manned aircraft, and land immediately if necessary.
- It is forbidden to use aircraft on the scene of large-scale events. These venues include but are not limited to: sports competition venues and concerts.
- Never fly in areas prohibited by local laws.
- Ensure that the aircraft will not affect the large manned aircraft on the route when flying. Always be vigilant and avoid other aircraft.

Safety Precautions

The remote control model UAV is a high-risk commodity, so keep away from the crowd when flying. Improper assembly or damage to the body, poor electronic control, and unfamiliar operation can all lead to unpredictable accidents such as damage to the drone or personal injury. Operators must pay attention to flight safety and understand all responsibilities for accidents caused by their negligence.

- Keep away from obstacles and people

The remote control drone has uncertain flight speed and status when flying, and there is potential danger. When flying, you must stay away from crowds, high-rise buildings, high-voltage power lines, etc., and avoid flying in bad weather such as wind and rain. The commissioning and installation of the drone must be operated strictly in accordance with the operating instructions. Pay attention to maintaining a distance of 1-2 meters from the user or other people when the drone is flying. And the body, causing injury.

- Keep away from humid environment

The interior of the drone is composed of many precision electronic components and mechanical parts. Therefore, it is necessary to prevent the drone from getting wet or water entering the body, so as to avoid accidents caused by mechanical and electronic component failure. During maintenance, please wipe the surface stain with a clean cloth.

- Avoid manipulation alone

The remote control drone control technique has certain difficulties in the early stages of learning. To avoid flying alone, you need the guidance of experienced people.

- Proper use of this product

Please use our original parts for modification or maintenance to ensure the safety of flight. Please operate and use the product within the scope permitted by the product function, and shall not be used for any illegal purpose other than safety regulations.

- Safe operation

1. Please operate the remote control drone according to your state and flying skills. Fatigue, mental retardation, or improper operation will increase the risk of accidents.

2. Do not use near your ears! Misuse can cause hearing damage.

- Keep away from high-speed rotating parts

When the drone rotor is rotating at high speed, please keep the pilot, surrounding people and objects away from the rotating parts to avoid danger and damage.

- Keep away from heat sources

The remote control drone is composed of metal, fiber, plastic, electronic components and other materials, so it should be kept away from heat sources as much as possible to prevent sunlight, deformation and even damage due to high temperature.

- Environmental requirements

Discard this product at will, which may have an impact on the environment. Please recycle properly in accordance with local laws and regulations.

Product configuration

Packing List

	Drone	x1
	Remote control	x1
	Obstacle avoidance equipment	x1
	Body battery (3400mAh)	x1
	USB charging cable	x1
	screwdriver	x1
	Spare Propeller (2)	x2
	Manual	x1

Drone part names

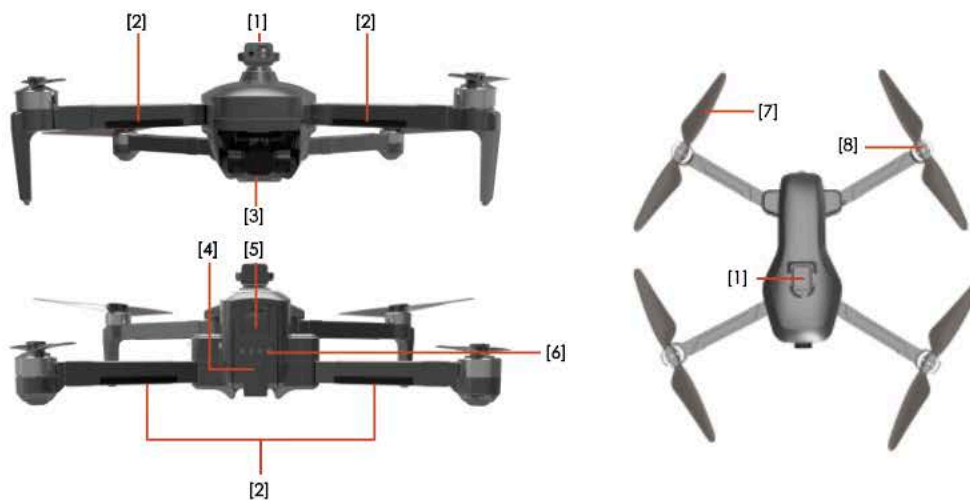

[1] Obstacle avoidance equipment [2] LED light [3] HD camera [4] Power switch [5] Smart lithium battery [6] Power indicator [7] Wind blade [8] Motor [9] LED light

1. Propeller installation

Please make sure that all propellers are installed in the correct orientation as shown in the figure below. If the installation is incorrect, the aircraft will not fly normally.

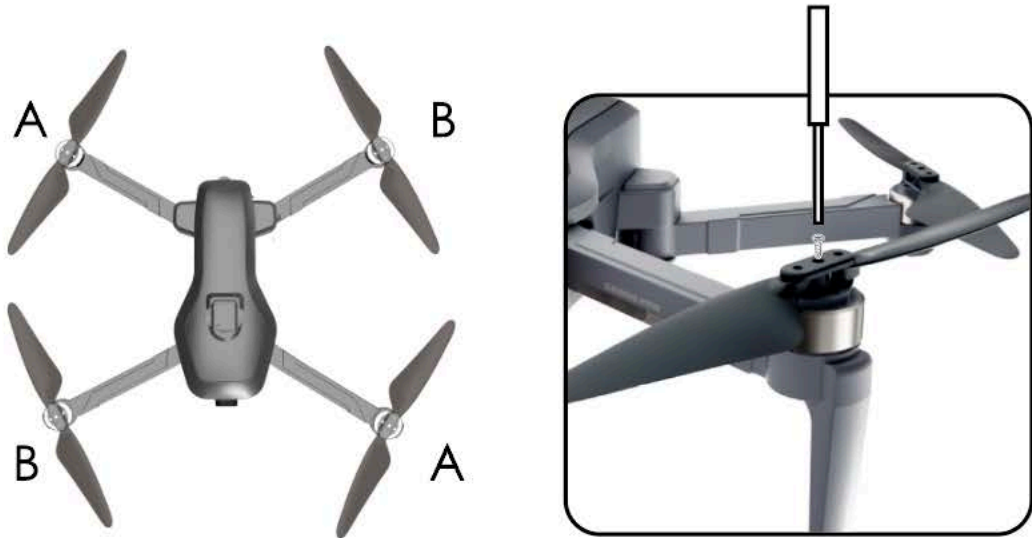

2. Aircraft lithium battery

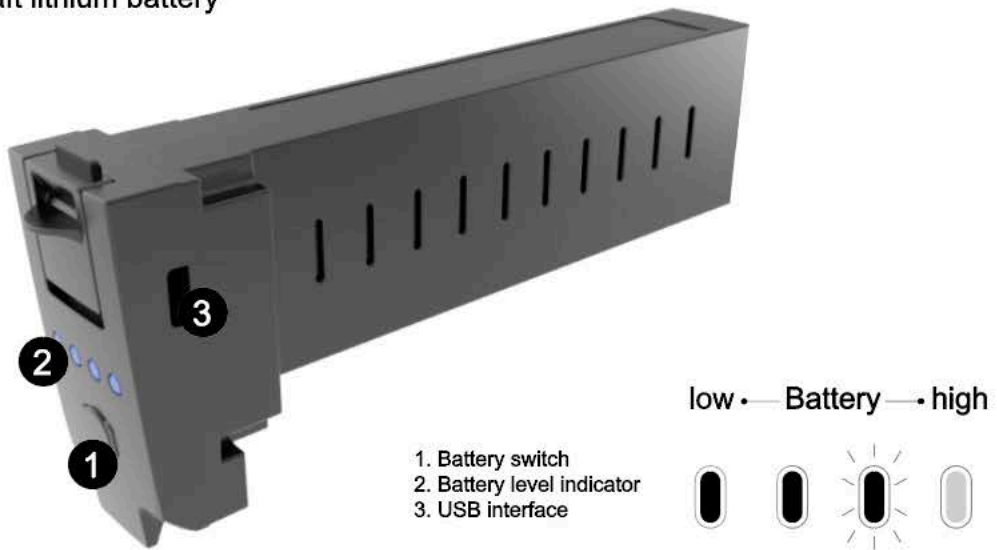

-Press and hold the power button for 3 seconds to turn on, and then press and hold the power button for 3 seconds to turn off.

-Once the battery is in a low power state, and there is 1 light left in the battery indicator, please charge the battery immediately to avoid unnecessary losses.

Battery installation

Press the battery button down, and then push the battery into the drone's battery slot. If installed successfully, the battery clip will pop up, which locks it securely in place.

⚠ Tips: If the battery is not installed properly, it is likely to cause a drone to interrupt the power supply and fall accident.

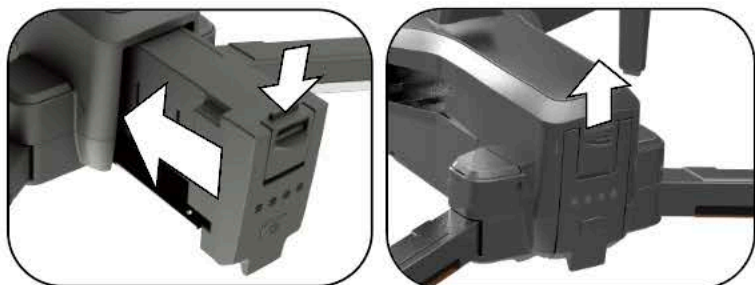

Battery removal

Press the battery latch down and pull battery out.

Keep fingers & machine clean and dry before operation, otherwise the battery may not slide out smoothly. slipped out. If you ever notice the battery is very difficult to remove or even STUCK, then check the battery for swelling or puffing. If swollen, discard of it immediately. Swelling can lead to explosion. It must have been overcharged at some point and is now defective. New batteries can be found on our website.

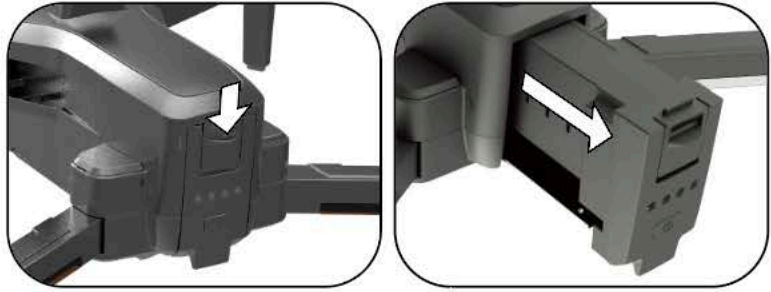

Drone battery charging

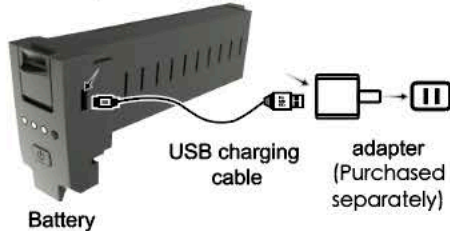

⚠ Tips:

- Insert the plug in the correct way.
- It is recommended to use 5V 1-2A adapter for charging.

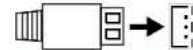

• When charging the rechargeable battery, do not allow children to do it. It must be carried out under the supervision of an adult. It must be kept away from flammable materials during charging and at all other times. The guardian should not leave the aircraft or its batteries unattended while charging.

• Do not short circuit or squeeze the battery. This can result in an explosion. Only charge **INDOORS**.

• If battery is ever puffy, swollen, or bigger in size at any moment, immediately stop use (or stop charging) and dispose of properly right away. Swollen batteries are at greater risk of explosion because they are not stable.

• The power supply terminals should not be taken out of the model, and the terminals should not be short-circuited; do not short-circuit, disassemble or throw the battery into fire or expose to high temperatures. Do not place the battery in high temperature environments (such as in/near a fire, in/near the sun, near any heating device, or even outside on a day over 85 degrees.).

• This drone, remote control, and battery can only use the recommended charging cord that was included with your order, and can only use the recommended 5V 1-2A adapter for charging. if you need a replacement charging cord or any other accessories, please visit our website or contact us at Admin@DroneCloneXperts.com . Regularly check wires and parts for damage. If you find any damage, stop using it until the repair is complete.

• The battery must be charged and stored after the flight. If not in use, it is recommended to charge the battery at least once every 3 months to avoid over-discharging the battery and permanently damaging the battery.



Reminder About Drone Camera: To view the **LIVE** video feed from the drone's camera, your phone has to be connected to the drone's wifi network, and you have to use the HFun Pro app. To download the process, please refer to our instructional video and to the camera function description section of this manual.

3. Change Camera Angle

On the **BACK - RIGHT** side of the remote control (towards the top), there are 2 small buttons. These buttons control the camera angle up to 110°, and can be adjusted at any point during flight (or before / after flight as well).

See photo for details and remember you're looking at the **BACK** of the Remote

When the "A" button in photo is pressed, the camera moves **UPWARDS** in the direction of "A". When the "B" button is pressed, the camera is adjusted **DOWN** in the direction of B. Letters are for photo purposes **ONLY**, so buttons may not actually be labeled with "A" & "B" letters.

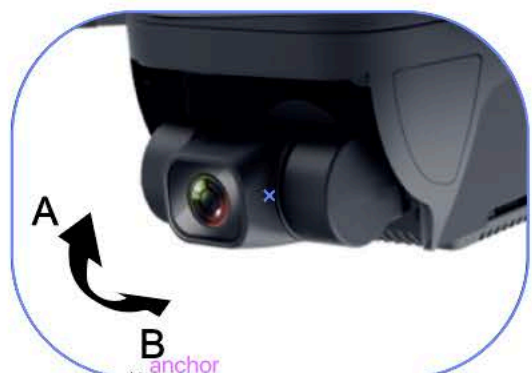
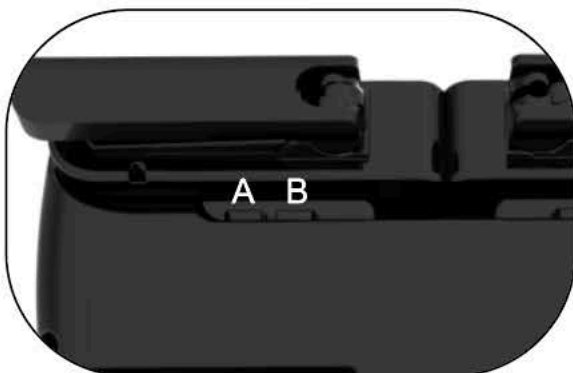

Remote control part names

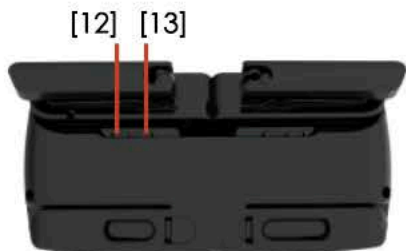

[12] Camera up
[13] Camera down

- [1] Remote control power switch located on side of remote
- [2] Speed key / Long press for 5 seconds to calibrate the gyroscope
- [3] Return home
- [4] LCD display
- [5] Video button (record video)
- [6] Camera button/long press for 5 seconds to correct geomagnetism
- [7] Ascend, descend, turn left, turn right
- [8] One-key take-off / One-key landing
- [9] GPS switch

The default GPS mode is turned on. You can turn off GPS mode to take flight faster, but this is strongly discouraged since you won't have GPS in emergency.
[10] Headless mode
[11] Fly right and left, forward and backward

LCD display

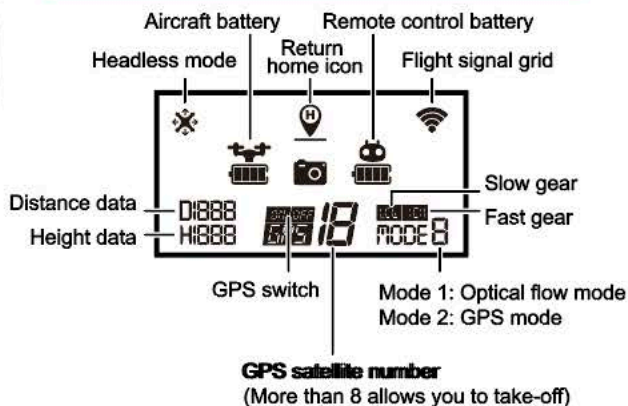

Remote control battery charging

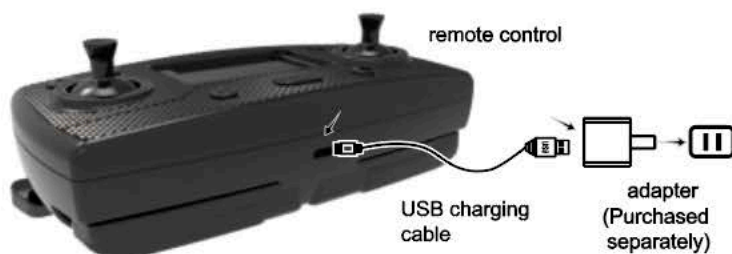

⚠ Tips:



- Insert the plug in the correct way.
- It is recommended to use 5V 1-2A adapter for charging.

Pre-flight inspection

1. Are the batteries of the remote control and drone sufficiently charged?
2. Are the propeller blades installed correctly?
3. Does the motor start normally?
4. Am I in GPS Mode (Mode 2)? Do I have more than 8 Satellites? If yes, then you are in GPS Mode and drone is unlocked for flight
5. Is the Geomagnetic Interference low enough to fly safely in? **See our Instruction Video for more detail on this topic**

Drone Pairing with Remote Control

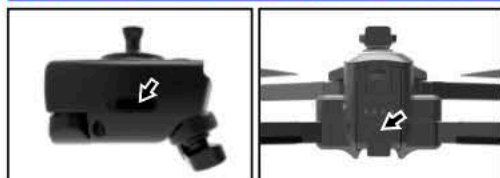

1

2

Always turn ON the remote control first. Next, **press and hold** the drone battery button ON until the drone lights flash and beep sounds. You'll notice the Remote Control lights turn solid and won't flash.

Geomagnetic correction function—Also known as **CALIBRATION** (see video for demonstration)

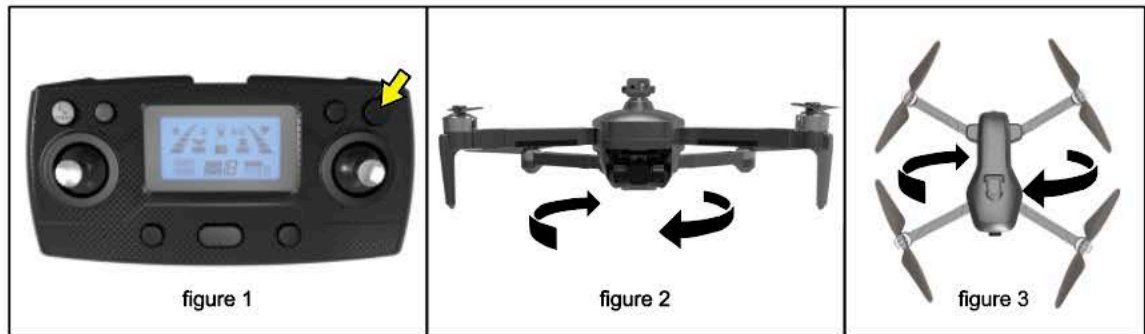

After the drone is successfully linked, press and hold the remote control camera button for about 5 seconds (Figure 1), the remote control will beep once, the drone light will flash quickly, pick up the drone 1 meter from the ground and turn it clockwise 3 (Figure 2), at this time, the remote control drops a beep and the drone is erected, the camera is facing downward (Figure 3), and the clockwise turn of the remote control drops the drone light once every 1 second. can.

Tips: Please make sure that the take-off environment is open, and the satellite signal is greater than 7 stars before take-off.

- Do not perform calibration in areas with strong magnetic fields, such as magnetic deposits, parking lots, construction areas with underground steel bars, etc.
- Do not carry ferromagnetic materials with you during calibration, such as keys and mobile phones.
- Do not calibrate near large pieces of metal.

Drone gyroscope and gimbal level correction



Place the drone still on a horizontal surface, then press and hold the SPEED button on the remote control for 5 seconds until you hear a beep, as shown in the figure.

The drone light changes from fast flashing to slow flashing.

The Gimbal/Camera will begin to correct itself and continue to do so for 25 seconds until completely horizontal and stable.

Connect with APP (HFun Pro is name of app & can be found in all app stores)

Either scan the QR code found on page 4 of this manual, or simply search your phone's app store for an app named **HFun Pro**. Download the **HFun Pro** app, then go to your smartphone's WiFi Settings to locate the correct network to connect to. Select network named "XL-PRO-5G-*** {or similar}" in the WIFI list, then exit the interface and open the **HFun Pro** app.

Note: Before doing this, please make sure the REMOTE CONTROL is turned on. If you connect to the network with the remote control off, then you may not be able to control the drone with the remote. If this happens you'll have to restart the process by going to your smartphone's wifi settings, then select "Forget Network" (next to the name of the network), turn the remote ON this time around and restart the setup process mentioned.



Remote control (Mode 1 & Mode 2) **Watch Instruction Video for detailed info!**

Mode 2 is GPS mode, and is the default mode. This means when you start the drone, the drone will eventually enter Mode 2 once GPS signal strength is strong enough (must be outside for drone to communicate with GPS satellites, preferably in an open place free of signal interference such as high-rise buildings & high-voltage wires).

Mode 1 is Optical flow mode and not a mode we suggest flying in often since it's not protected by GPS in this mode. To fly in mode 1, you'll need to turn off the GPS function before taking flight by pressing the middle button on the remote control will

[NOTE: You can't turn off Mode 2 (GPS mode) after GPS positioning is achieved. You'll have to restart drone & remote]

Mode switch

1. Mode 1: [Optical flow mode] It is suitable for indoor open areas. After the drone and remote control are linked, the geomagnetism and gyroscope are corrected, the display on the remote control changes from Mode0 to Mode1, and the drone will automatically perform GPS search satellite positioning, automatic protection program will not be able to take off, you need to press and hold the video button for 5 seconds, the remote control emits a "dip", which means that the GPS can be unlocked after taking off. (Note: Mode1 optical flow mode does not have a series of GPS functions such as low-power return, one-click return, etc. Please pay attention to the flight distance and altitude when using)



2. Mode 2: [GPS / optical flow dual mode] It is suitable for outdoor open areas without signal interference. After the drone and remote control are linked, the geomagnetism and the gyroscope are corrected, the display on the remote control changes from Mode0 to Mode1. UAV automatically performs GPS satellite search and positioning (Drone search is placed in an open area, and there are no high-rise buildings or cars, high-voltage wires and other obstructions around it, otherwise the drone may not be able to complete the GPS satellite search and positioning), When the number of satellites reaches about 10, the positioning is completed, the remote control emits a "drop", the remote control display changes from Mode1 to Mode2 to indicate that the positioning is successful, and you can unlock the takeoff. (Note: Before GPS mode is completed, the drone will automatically take off the protection program and it will not take off)

LOW gear switch HIGH high gear

Note: The product is turned on by default in LOW low-speed gear mode, and the drone has forward obstacle avoidance function. If you switch to HIGH high-speed gear mode, the forward obstacle avoidance function of the drone will automatically fail. At this time, the drone will not have all obstacle avoidance functions. . Need to pay attention to the flight height and distance, pay attention to the surrounding flying environment, to avoid damage to the drone due to improper flight.

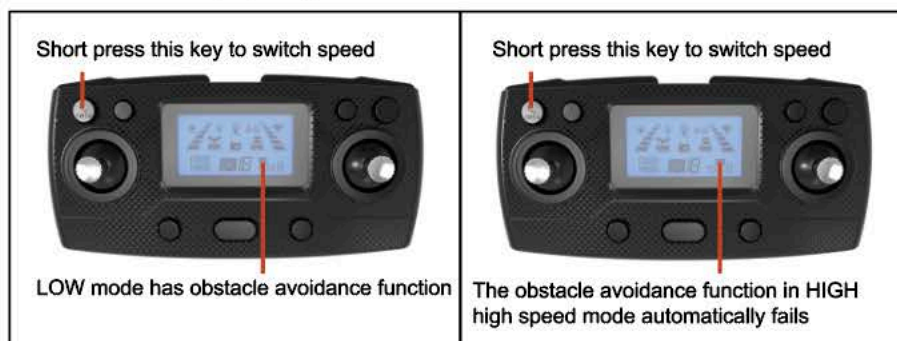

Drone unlock



At this time, the throttle stick and the directional stick are pushed to the lower left corner and the lower right corner at the same time (Figure 1), or pushed to the lower right corner and the lower left corner (Figure 2) at the same time, the unlocking can be completed and the motor can fly after starting.

Basic flight

Basic flight steps

1. Code the remote control with the drone, and the drone completes the initialization.
2. Geomagnetic calibration. (Do not need to calibrate each time at the same location)
3. After the drone gyroscope is detected, unlock the drone.
4. Push the throttle stick up, the drone will take off, and the left / right joystick will control the attitude of the drone.
5. Turn off the power of the drone first, and then turn off the power switch of the remote control.

Flight control method

Remote Control	Drone
	 <p>Rise</p> <p>Decline</p>
	 <p>Turn Right</p> <p>Turn Left</p> <p>Before</p> <p>Rear</p>
	 <p>Go Ahead</p> <p>Back</p>
	 <p>Fly Left</p> <p>Fly Right</p> <p>Before</p> <p>Rear</p>

Flight mode

One-click takeoff / landing



- Once the drone is unlocked (blades will be spinning), press the one-button take-off button while blades are still spinning, and the drone will automatically take off to hover at a height of about 1.5 meters.
- When the drone is in flight, press the one-button take-off button briefly, and the drone will automatically land right there.

Headless mode



Press the headless mode button, the remote controller will make a "beep" sound. In this mode-- Right and Left direction remain the same regardless of which way the drone's nose is facing. This is a fun mode to try out and can make things easier for beginners, but not a mode you really want to learn in.

RETURN TO HOME (Not available in Mode 1 optical flow mode)

The drone has a home function. If the home point is successfully recorded before take-off, and the communication signal between the remote control and the drone is somehow lost, or the home key is pressed, the drone will automatically return to the home point and land to prevent accidents.

There are three different ways for drones to return home:

1. One-click return
2. Signal return
3. Low battery return.

Note for return flight:

- During auto return, the drone cannot avoid obstacles, so it immediately climbs to an altitude of 30M to clear any obstacles on its route home.
- When GPS signal is not good or GPS is not working, you cannot return to home.

Home Point: During takeoff or in-flight, when the GPS signal receives more than 7 or 8 Satellites for the first time, MODE 1 changes to MODE 2. At this time, the current position of the drone will be recorded as the home point.

One-click return



When the GPS signal is good (the number of satellites is greater than 8), you can send the drone home by pressing the return to home button on the remote control (shown in figure on left). The home process is the same as the uncontrolled home. You may use the stick to control the drone to avoid obstacles in its path, but **remember the drone immediately climbs to an altitude of 30M** to help avoid any tall objects on its route home.

To EXIT "Return to Home" automation, simply press the home button again and you will immediately regain control of the drone.

Loss of signal return

If the remote control signal and the APP signal disconnect for more than 6 seconds, the flight control system will autonomously take control of drone. The drone will fly back home until stronger communication is found, and then allow you to take control from there. This can happen unexpectedly-- even if GPS signal is initially good (the number of GPS satellites is greater than 8), the compass is working normally, and the drone successfully records the home point.

Low battery return

After the drone battery enters low-voltage, the indicator light will flash slowly (RED). At this time, the drone will climb to 30m height and then automatically return to the vicinity of the takeoff point. (After the low-power drone returns to the vicinity of the take-off point, the height and distance of the drone will be limited to 20 meters. Battery must be charged.)

 **Reminder:** When drone is in low-power return mode, the remote control cannot cancel the return mode.

Photo / Video

Press the remote control "📷" button to take a picture, the remote control LED screen display icon "📷" flashes, press the remote control "🎥" button to record, the remote control LED screen display icon "🎥" has been slow flashing, then press the "🎥" button to exit the recording .



Received signal strength indication

The icon "📶" is the signal strength between the drone and remote control. The more segments that are displayed, the stronger the signal is, and vice versa.

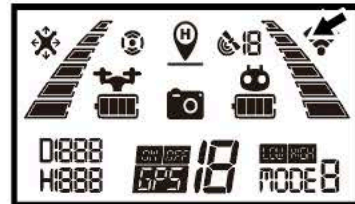

Product parts

Basic parts - Purchase Replacements on our website or contact Admin@DroneCloneXperts.com

Upper shell	Lower shell	panel	Garnish	A/B fan blade
Front rocker A	Front rocker B	Rear swing arm A	Rear swing arm B	camera
Silicone pad	battery	Geomagnetic module	GPS module	Motherboard
Charging Cable	remote control	Obstacle avoidance equipment		

Don't panic if you encounter problems (FAQ Section)

No.	problem	Solution
1	Drone motors start, but drone won't take-off, the lights flash quickly and slowly	Wait until remote indicates you entered into MODE 2. Mode 2 means GPS signal is strong enough to take flight (must have 8 or more satellites to lift off). If GPS signal is strong & it still won't fly, then simply restart the drone and recalibrate it. <i>*Please see video instructions at DroneCloneXperts.com to see how easy it is to calibrate your LIMITLESS 3 drone. ALL GPS drones, regardless of price, need to be calibrated properly.</i>
2	After take-off in Mode 1, the drone keeps blinking and cannot hover. <i>*(We suggest only to fly in Mode 2)*</i>	The ground is too smooth or the environment is too dark, which will cause the optical flow lens to be unstable. Please land and only fly in environments that have good lighting and where there is no reflection from the ground (i.e.-reflection off water or metal)
3	After taking off in Mode 2, the drone keeps blinking and can't hover. It floats around. The remote control keeps switching between Mode 1 and Mode 2.	GPS Signal is not strong, too much interference, please find an open, unobstructed environment to fly in with no high voltage wires or other sources of signal interference. <i>*Learn more about what causes interference by heading to our website www.DroneCloneXperts.com</i>
4	Human Tracking/Follow Me, Gesture Control, or other features aren't working	You are in the wrong MODE. If you are in Mode 2 (gps mode), you have to use GPS tracking. If you are in Mode 1, although we strongly suggest not to fly in Mode 1 for reasons which are explained in the LIMITLESS 3 instructions video on our website.
5	Drone shakes a lot	The propellers are deformed or damaged--Need to be replaced
6	The picture/video is tilted during aerial photography	Land the drone and perform the gimbal level correction by simply holding the SPEED button down for 5 seconds on the remote control. This will reset and correct the gimbal angle.
7	The obstacle avoidance device is rotating normally during flight, but it's not detecting obstacles.	Land the drone, Turn power OFF, Restart drone
8	During the flight, obstacle avoidance device is not rotating normally and has no obstacle avoidance function	Land the drone, turn off the power, pull out the obstacle avoider, reinstall the obstacle avoider, and turn power back ON.

We suggest NEVER to fly in MODE 1 (optical flow mode). Fly in Mode 1 at your own risk. If signal interference in MODE 2 (GPS mode) drone will return to you

Software instruction manual

Software installation instructions--SEE DEMONSTRATION VIDEO on our website

1. Install the HFun Pro App on smartphone or tablet.

Please scan the QR code below to download the mobile app to the corresponding website.



IOS

Either Scan the code with your phone's camera OR go to the app store on your phone and search for an app named HFun Pro. Then download it to your phone and/or tablet.



Android (google)

2. Connect Drone WiFi

1. Power on the drone;
2. Go to your smartphone's WiFi settings and find the network that says XL-PRO-5G-** or similar
3. Click that network to connect to the Drone's WiFi and then open the HFun Pro App to Prepare for Flight.

1. Power on the drone;
2. Go to your smartphone's WiFi settings and find the network that says XL-PRO-5G-** or similar
3. Click that network to connect to the Drone's WiFi and then open the HFun Pro App to Prepare for Flight.



3. Recommended model configuration

(1) ios

Configuration	Recommended	Optimal (Support 2 k)
Product model	iPhone 6 and above	iPhone 6 and above
System version	iOS 8.0 and above	iOS 9.0 and above

(2) Android

Configuration	Recommended	Optimal(Support 2 k)
The CPU model	Snapdragon 630 and above Samsung Exynos 7420 and above Hair division Helio X25 and above Kirin 950 and above	Snapdragon 835 and above Samsung Exynos 8895 and above Hair division Helio X30 and above Kirin 970 and above
System version	Android 5.0 and above	Android 8.0 and above
Memory size	3G and above	6G and above
CPU usage	Occupancy rate of 25% and below	Occupancy rate of 10% and below

APP function introduction: When the drone is in the following environment, the fixed hover effect is not good.

Note: ONLY 1 DRONE AT A TIME CAN CONNECT TO THIS NETWORK.

Note: When the drone is in the following environment, the fixed flow hovering effect of the lower lens is not good, which will make it difficult for the drone to fly smoothly and the camera will shake.

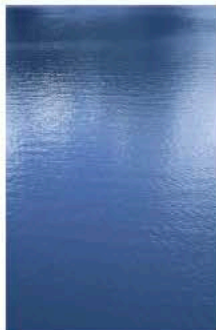

The surface of the water



Dimly lit



Large vertical gap



Smooth reflective ground

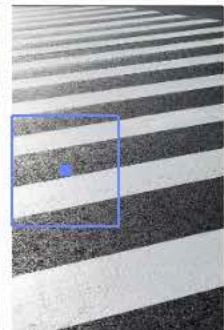

Two-color stripe

1.1 Introduction to the Operation Interface

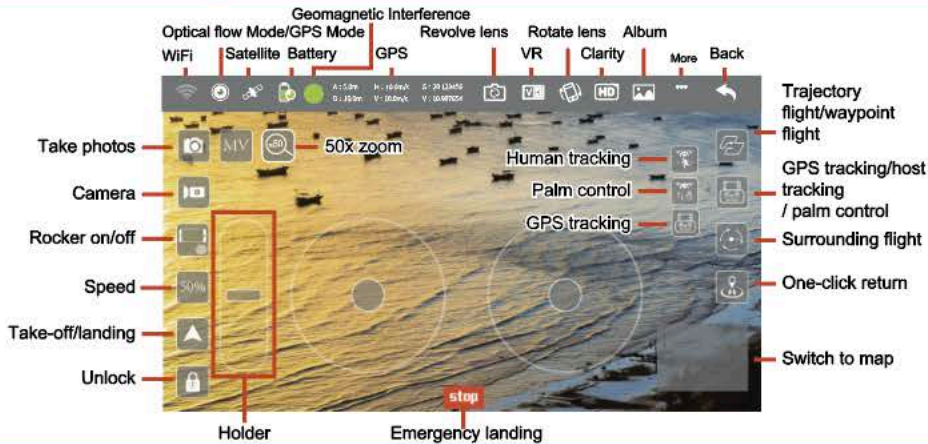

1.2.1 Function Description

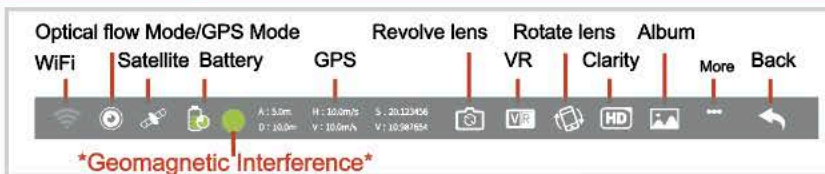

WiFi: Signal strength between your mobile phone and your drone's WiFi (LIMITLESS 3 emits its own WiFi signal that your phone connects to).
Satellite Signal: Represents current flight mode (Optical Flow mode or GPS mode) and also shows the number of satellites the drone is currently connected to. If the screen and remote control show LESS THAN 8 satellites, then your drone is in MODE 1 (Optical Flow mode) and you have to wait another minute to gain a stronger satellite GPS connection. You will only be able to take flight once connected to MORE THAN 8 satellites, the remote will beep at this time and you'll notice the drone will no longer prevent flight.

If the icon is flashing, then the current mode is "optical flow mode" (mode 1). Fly in mode 1 at your own risk since GPS return to home is NOT possible in mode 1. If the icon is a constant / solid light, then the current mode is "GPS mode".

(Please watch video on our website DroneCloneXperts.com for a very important lesson on Mode 1 vs Mode 2, otherwise you can lose your drone accidentally)

Battery: Shows the battery power status of the aircraft.

Once the battery shows RED, it's in low power state, and the aircraft will soon perform the Automatic Return Home function to keep the drone safe. Please remember that once the drone enters Low Power state, you won't have control over it until it lands safely. Once Low Power state is engaged, the drone instantly flies to an altitude of 30M to ensure it clears any high-lying obstacles on its return home. If you are flying and notice your battery is close to entering Low Power state, then please make sure you aren't under trees or bridges..otherwise the drone could get damaged on its ascent to 30M height. [This topic is covered in the Instructional Video at DroneCloneXperts.com](http://DroneCloneXperts.com)

GPS information: Displays the height, distance, and corresponding longitude & latitude of your LIMITLESS 3 drone from the reentry point.

***Geomagnetic interference*:** Geomagnetic Interference is BAD for all Drones. Inside the Green dot, color-coded stars will appear to alert you of interference. The LOWER number of stars you have the LESS interference is present.

Star COLOR is also important to note: Green = Normal; Yellow = Some Interference; Orange = Strong Interference; Red indicates Very Strong Geomagnetic Interference. When the orange or red icon is displayed, leave the current interference position immediately and recalibrate.

Revolve Lens: Can switch between front lens and down lens.

VR Mode: Click into VR mode if you have compatible FPV VR Headset/Goggles.

Rotate Lens: Flips the screen upside-down to help you adjust your phone view.

Clarity: Click to switch the LIVE-VIDEO clarity from SD to High Definition. This won't impact clarity of video recordings or photos.

Album: Any and all videos & photos taken from your drone can be viewed.

1.2.2 Function Description

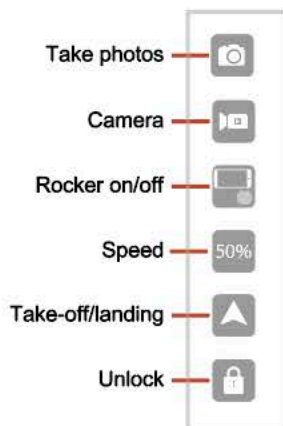

Take photos: Click the button to take photos according to the current lens (front lens or down lens).

Camera: Click the button to shoot videos according to the current lens (front lens or down lens).

Rocker on/off: Click to switch to fly with mobile phone control only rather than fly with the remote control.

Speed: Displays the current state of speed setting. Click to switch between fast/slow in mobile control mode. Speed button on remote as well.

Take-off/landing: After the calibration is completed, place the aircraft horizontally and click the unlock button to start the flight operation.

Unlock: Drone will spin its motors for potential take-off (if in mode 2)

1.2.3 Function Description

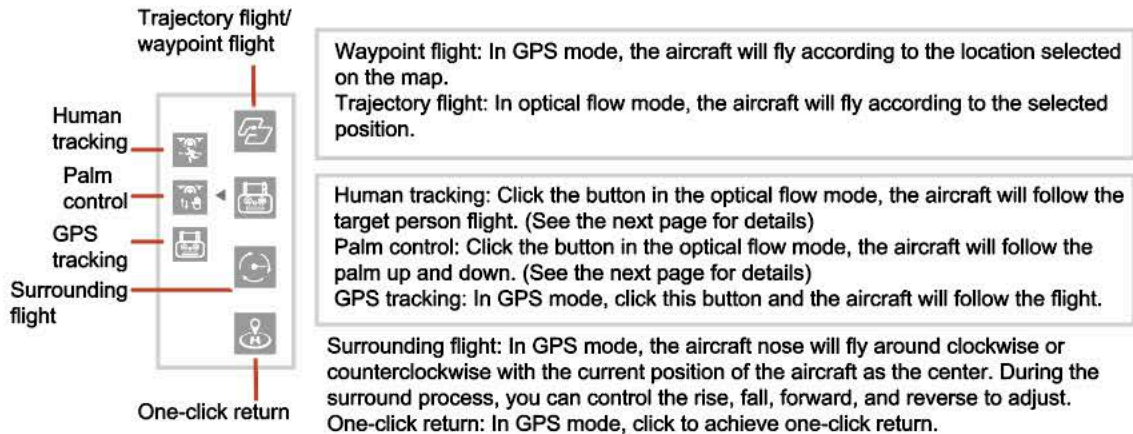

* Other Instructions--See video for info on which functions work in each mode (Modes 1 & 2)

Human Tracking (Only available in Mode 1)

- (1) Blue candidate boxes for the target person appears on the screen.
- (2) On the screen, tap your finger to select the target character.
- (3) After the target person is locked, the blue box will turn red. Make sure the red box target character is in the middle of the screen.
- (4) The tracking flight starts when the aircraft is about 2m away from the target figure. If the target character is lost, you need to click the target character again.

When the red frame is more than 80% of the human area, the best effect can be achieved.

Palm Control (Mode 1 only)

- (1) facing the camera of the aircraft, lift it horizontally with one hand;
- (2) when the palm is framed by the red square on the App, gently move the palm;
- (3) at this point, the aircraft will follow the palm upward and downward flight;

When the distance between the palm and the camera is about 1m, can obtain the best experience.

1.2.4 Function Description

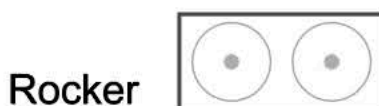

Holder

After the aircraft takes off, the holder will be displayed on the left side of the screen. At this time, if you move the slider upward, the front lens of the aircraft will move upward by a certain angle; if you move the slider down, the front lens of the aircraft will move downward by a certain angle.



Rocker
The left rocker can control the upward, downward movement, left and right turn of the aircraft, and the right rocker can control the forward, backward movement of the aircraft, and it can also move the aircraft towards the left and right.

share

After clicking  in the upper left corner of the screen on the control page, enter the album interface. When you click to view a photo or video, users can share photos or videos to major social platforms through  in the top right corner.

1.3 Gesture Recognition

Facing the front lens of the camera, the following gestures can be triggered to trigger the automatic camera or camera function of the aircraft:



Take Photos by Yeah Gestures About 2m in front of the camera of the aircraft, hold the Yeah gesture with one hand flat. After the aircraft successfully recognized the gesture, the countdown of 3 seconds began to take photos;



Shoot Videos by Box Gestures About 2 meters in front of the camera of the aircraft, put your hands on the position of the face jaw to make a square video gesture. After the aircraft has successfully recognized the gesture, the video will start. When the gesture is recognized again, end the recording (the time difference between two recognition should be more than 3 seconds);



Shoot Videos by Palm Gestures About 2 meters in front of the aircraft lens, with five fingers and one hand flat; After the aircraft has successfully recognized the gesture, the video will start. When the gesture is recognized again, end the recording (the time difference between two recognition should be more than 3 seconds);

* Special Instructions

To ensure that the lens gets a higher recognition rate :

1. Please aim the lens face to face;
2. Please fly in a good light environment;
3. Please conduct gesture recognition operation at a distance of about 2m from the lens.

In the following cases, it will result in a low lens recognition rate :

1. Weak light or backlight;
2. The WiFi signal is weak or the signal is disturbed.

2 MV Interface



After clicking the  button in the upper left corner of the screen on the control page, enter the MV interface. In the MV interface, you can shoot music videos.

Rotating picture

Click this button to enable the Rotate Screen feature. At this point, the finger swipes on the screen to rotate the image; if the finger double-clicks anywhere on the screen, the image can be magnified in an instant (this feature also applies when recording video).

Filter Operating lever

Photo album

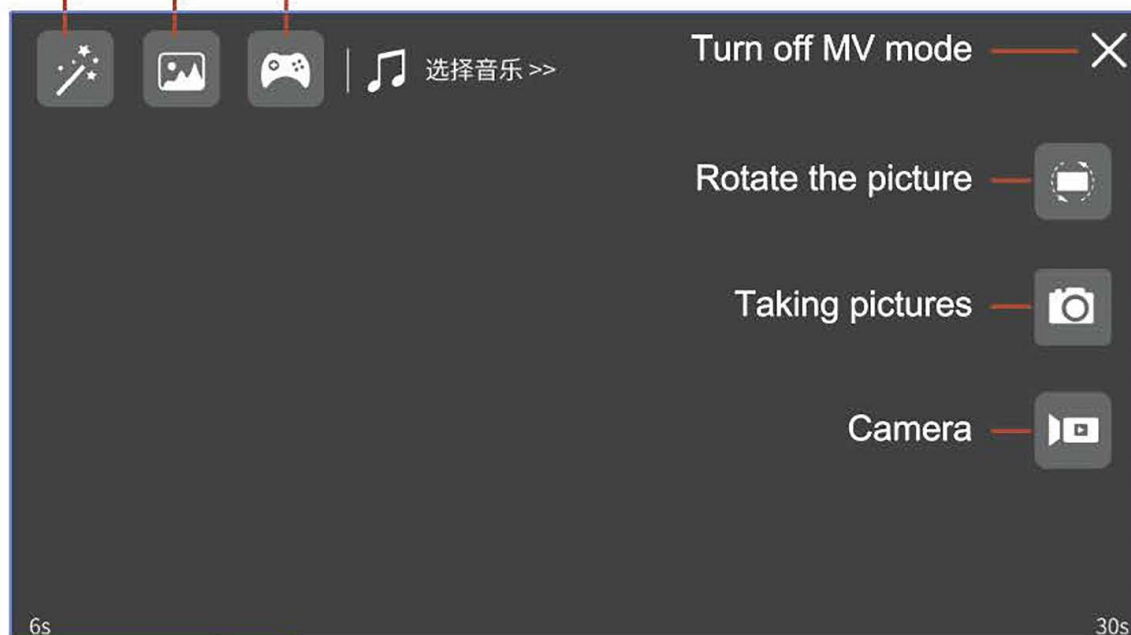

Length of recorded time

Recording progress bar

Length of music time