



OPERATION & MAINTENANCE MANUAL



⚠ WARNING:

Breathing diesel engine exhaust exposes you to chemicals known to the State of California to cause cancer and birth defects or other reproductive harm.

- Always start and operate the engine in a well-ventilated area.
- If in an enclosed area, vent the exhaust to the outside.
- Do not modify or tamper with the exhaust system.
- Do not idle the engine except as necessary.

For more information go to www.P65warnings.ca.gov/diesel

⚠ WARNING:

This product can expose you to chemicals including carbon monoxide and benzene, which are known to the State of California to cause cancer and birth defects or other reproductive harm.

For more information go to www.P65Warnings.ca.gov.

TABLE OF CONTENTS

Table of Contents	3
Foreword	5
Safety	6
Safety Notes	6
Operating Safety	7
Accidental Start-up	7
Moving Parts	8
Fire	8
Engine Exhaust	9
Voltage Hazard	10
Burn Hazard	11
Information	12
Specifications	12
Component Locations	13
The PTG Series Controller	16
Introduction	16
Interface	16
LCD Display	16
LED Status Light	17
Buttons	17
Modes	18
Controller Operation	18
Viewing Parameters	18
Event History	19
Operating the Generator Set	20
Pre-Start	20
Manually Starting the Generator Set	20
Remote and Auto Starting the Generator Set	21
Manually Shutting Down the Generator Set	21
Maintenance	22
Maintenance Schedule	23
Engine Oil Maintenance	24
Lubricating Oil Specifications	24

Checking the Engine Oil Level.....	24
Changing the Engine Oil and Filter	25
Cooling System Maintenance	26
Coolant Specifications.....	26
Checking the Coolant.....	27
Changing the Coolant	28
Cleaning the Radiator Core.....	29
Fuel System Maintenance.....	30
Fuel Pump.....	30
Fuel Lines.....	30
Fuel Specifications	30
Bleeding the Fuel System	31
Changing the Fuel Filters	32
Air Intake System Maintenance	34
Changing the Intake Air Filter.....	34
Service Log	35
Basic Troubleshooting.....	36
Wiring Diagrams.....	37
120/240 VAC – A Type Generator End with AS440 AVR.....	37
120VAC Only– CE Type Generator End with VR3.1B AVR	38
120/240VAC – CE Type Generator End with VR3.1B AVR.....	39
Control Wiring with PTG350 Controller.....	40
Revisions.....	41



FOREWORD

Thank you for your purchase of a Power Tech generator set. It is engineered to the utmost quality standards, manufactured in a strict quality control environment, and will assure you a long, satisfactory service. To have the best performance from your Power Tech generator, please fully read and understand this manual.

This manual is written to provide you with the information you need to safely operate and maintain your generator. This manual was up to date at time of printing/downloading, due to our continuous improvement of our products, we reserve the right to change the information contained in this manual without notice.

Power Tech recommends the use of only genuine Power Tech parts. Other parts may not perform as well, may damage the generator set, and may result in injury. In addition, the use of other parts may void your warranty.

For technical questions on your generator please contact your sales dealer, one of our authorized service centers or Power Tech's Customer Service Department at 1-800-760-0027. To expedite your call, please have the generator model and serial numbers available.

For service parts, please contact Power Tech's Parts Department at 1-800-760-0027 or order directly from our website at www.powertechgenerators.com.



**634 SR 44 W.
Leesburg, FL 34748
Toll Free: 800-760-0027
Fax: 352-787-5545
www.powertechgenerators.com**

SAFETY

SAFETY NOTES



This symbol indicates a safety alert. It is used to indicate potential personal injury hazards. Obey all safety messages that follow this symbol to avoid possible injury and death.

This manual has several types of safety precautions and instructions: DANGER, WARNING, CAUTION, NOTICE, and Note.

DANGER

Danger indicates the presence of a hazard that ***will cause severe personal injury, death, or substantial property damage.***

WARNING

Warning indicates the presence of a hazard that ***can cause severe personal injury, death, or substantial property damage.***

CAUTION

Caution indicates the presence of a hazard that ***will or can cause minor personal injury or property damage.***

NOTICE

Notice communicates installation, operation, or maintenance information that is safety related but not hazard related.

Note

Note indicates additional important or helpful information.

OPERATING SAFETY



Before operating this generator, be sure to read and understand all instructions. This generator set has been designed for safe operation in a specific application. **DO NOT** modify or use this generator set for any application other than that it has been designed for. Improper usage can cause damage, injury, or death. All installation and service work must be performed by properly trained and qualified personnel. Electrical installation, troubleshooting, and repair should only be performed by a qualified electrician.

The following guidelines should always be obeyed.

- Read, understand and follow all safety precautions and warnings before operating the generator set.
- Be sure to read and follow all safety decals affixed to the generator set.
- **DO NOT** modify the generator set. Unauthorized modifications may affect the life of the generator set; as well as, result in injury or death.
- The area around the generator set should be clean and free of debris.
- **DO NOT** operate machinery or equipment while under the influence of alcohol, medication, other drugs, or while fatigued.
- When connecting the generator set, be sure to follow any local, state, and National Electric Code (NEC) guidelines.

Accidental Start-up

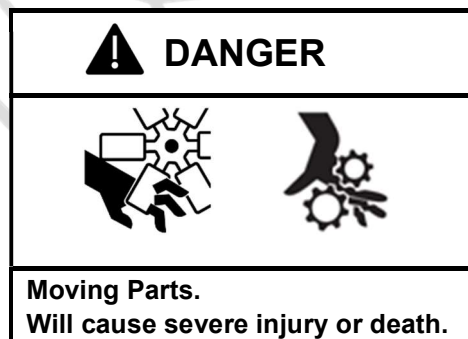

This generator set may start without warning. While in operation, there may be exposed moving parts.

- Before working on the generator set or connected equipment, ensure the generator set is disabled. The genset may be disabled by first properly shutting down the generators set. Next, disconnect the battery cables, negative (-) lead first, and/or turn the battery disconnect switch (if equipped) to the OFF position.

Moving Parts

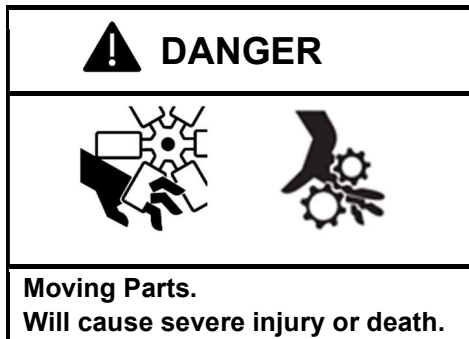

While in operation, there may be exposed moving parts.

- **DO NOT** wear loose, torn, or bulky clothing around the generator set.
- Be sure all guards and shields are in place before operating the generator set.
- Keep your hands and body away from all rotating parts, such as cooling fan, belts, pulleys, etc.
- Stop and disable the generator set before servicing.

Fire



A fire can cause severe injury or death. To reduce the risk of fire:

- **DO NOT** smoke near the fuel system or fuel tank.
- **DO NOT** operate the generator set in the vicinity of spilled fuels or flammable vapors.
- **DO NOT** operate the generator set in the presence of fuel leaks, fuel accumulation, or other flammable materials.
- Keep the engine and engine bay clean and free of accumulated dirt, grease, and trash.
- Keep the genset idling for 5-6 minutes before stopping. Temperatures around the genset may increase suddenly.
- **DO NOT** fill the fuel tank near open flames or while smoking.
- Shut down the generator set and allow it to cool before fueling.
- **DO NOT** run the generator set with a damaged, loose, or missing fuel cap.
- If fuel or lubricants spill, clean up immediately and properly dispose of.
- **DO NOT** attempt to use ether or other starting aids. Doing so may cause a flash fire and/or damage the engine.
- Inspect and replace any damaged wiring if necessary.

Engine Exhaust

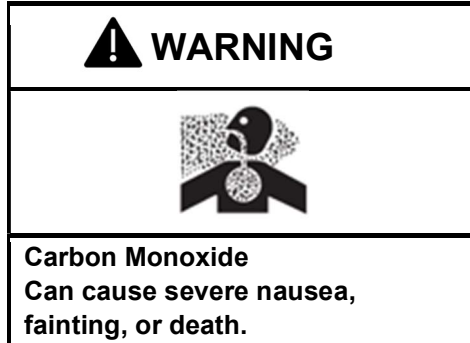

During operation, the generator set will release engine exhaust into the surrounding atmosphere. This exhaust contains carbon monoxide, an odorless, colorless, tasteless, nonirritating gas. The inhalation of carbon monoxide, even for a short period, can result in death. To reduce the risk of carbon monoxide poisoning:

- Avoid breathing engine exhaust while working on or around the generator set.
- **DO NOT** run the generator indoors unless the exhaust is routed outside properly.
- Routinely inspect the exhaust system for leaks and repair if necessary.
- **DO NOT** operate the generator set where exhaust fumes can accumulate and/or leak into an occupied space.
- **DO NOT** operate the generator set without a properly functioning exhaust system.

Carbon monoxide poisoning symptoms include the following:

- Dizziness, Light Headedness
- Physical Fatigue
- Weakness in muscles and joints
- Sleepiness
- Inability to Concentrate
- Mental Fatigue
- Blurred Vision
- Inability to Speak Clearly
- Stomachache, Nausea, and/or Vomiting

If you experience any of these symptoms, immediately seek fresh air. Remain active and do not sit, lie down, or fall asleep. Seek immediate medical attention if the symptoms do not improve when breathing fresh air.

Voltage Hazard



Whenever electricity is present, there is an electrocution risk. Following proper safety procedures can reduce the risk of electrocution.

- When connecting the generator set, be sure to follow any local, state, and National Electric Code (NEC) guidelines.
- Shut down the generator set and turn off all breakers before servicing the unit.
- Never make electrical connections while standing in water or on wet ground.
- Use extreme caution when testing voltage. It is advisable to have a trained and qualified person take the measurements.
- Inspect and replace any damaged wiring if necessary.
- Make sure all electrical covers are in place before operating the genset.

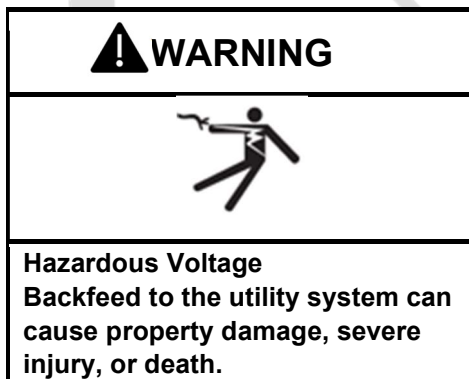



Whenever the generator set is connected as standby power, a transfer switch is required to prevent electrical backfeed into the utility electrical grid. Electrical backfeed is illegal and can result in the severe injury or death of utility company personnel working on power lines. The generator set must be installed following local, state, and National Electric Code (NEC) guidelines.

Burn Hazard

 WARNING

Hot Engine and Exhaust System Can cause severe injury or death.

 WARNING

Hot Coolant and Steam Can cause severe injury or death.

During operation, some components of the generator set can become extremely hot. These parts include, but are not limited to, the engine, exhaust manifold and piping, muffler, generator end, and voltage regulator. In addition, the engine coolant can become extremely hot and cause pressure to build up in the cooling system. Removing the pressure cap, before allowing the generator set to cool down, could cause hot coolant and/or steam to be released, resulting in severe injury or death.

- **DO NOT** touch or lean against hot exhaust or engine components.
- Allow the generator set to cool down completely before servicing.
- Never make electrical connections while standing in water or on wet ground.



INFORMATION

SPECIFICATIONS

ENGINE	
Make	Kubota
Model	V1505
Cylinders	4
Aspiration	Natural Aspiration
EPA Tier	Tier 4
HP @ 1800rpm (Continuous Duty)	18.0
Approximate Fuel Consumption	0.47 gal/hr @ ½ Load 1.1 gal/hr @ Full Load
Starting Voltage	12VDC
Battery Cable Gauge	2 AWG Minimum
Oil Capacity	Approx. 4.5 Qts (4.3 L)
Cooling System Capacity	Approx. 6.5 Qts (6.1 L)

GENERATOR		
Generator Type		Brushless with Automatic Voltage Regulator
Generator Output (Continuous Prime)	PT-10KSIC	10000W @ 60Hz 8300W @ 50Hz (Optional)
	PT-12KSIC	12000W @ 60Hz 10000W @ 50Hz (Optional)

MAINTENANCE PARTS	
Replacement Air Filter Element	04FA221
Replacement Primary Fuel Filter	08FF17
Replacement Inline Fuel Filter	08FFG17B
Replacement Oil Filter	01FO05S
These and other additional parts available at powertechgenerators.com .	

COMPONENT LOCATIONS

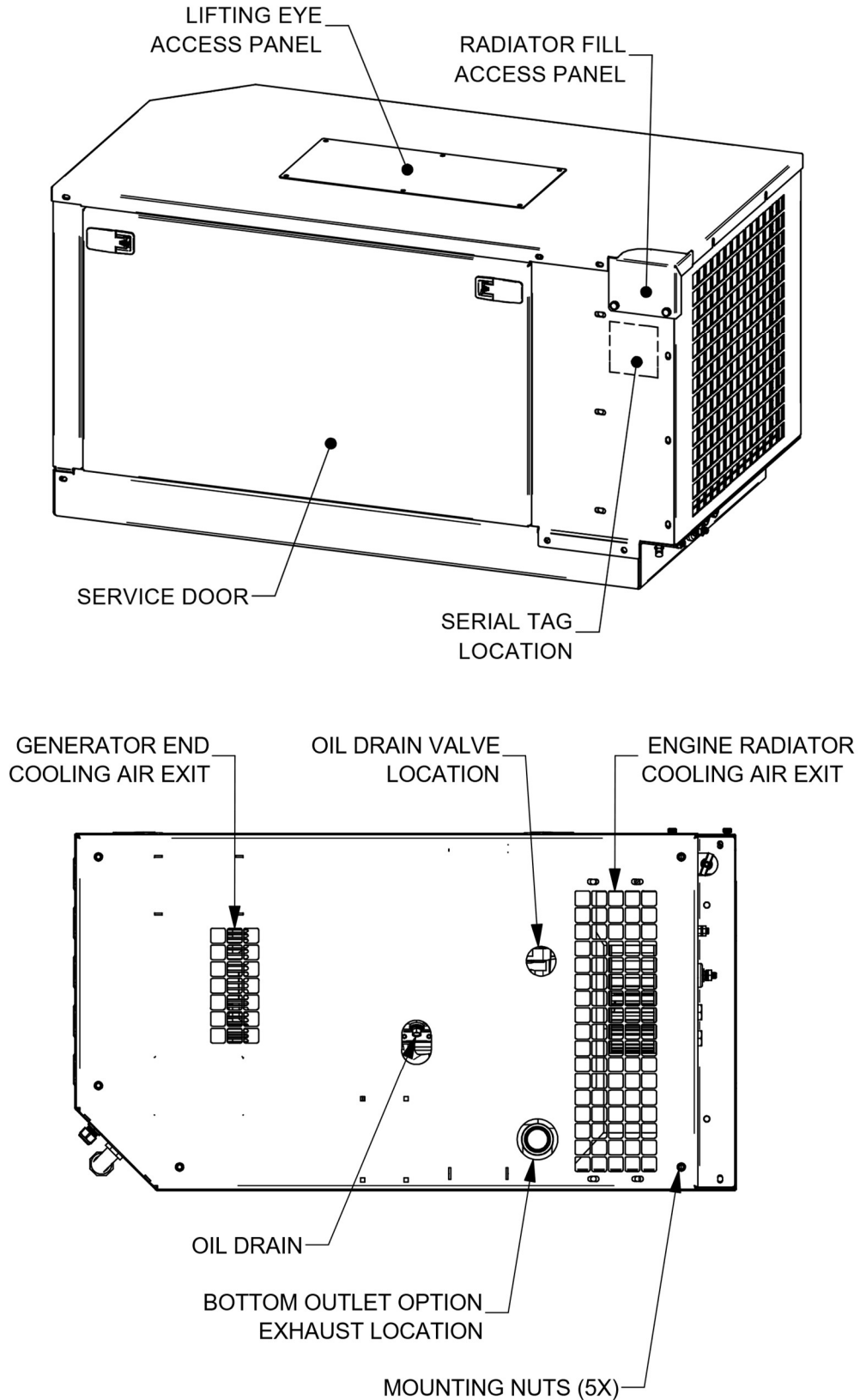

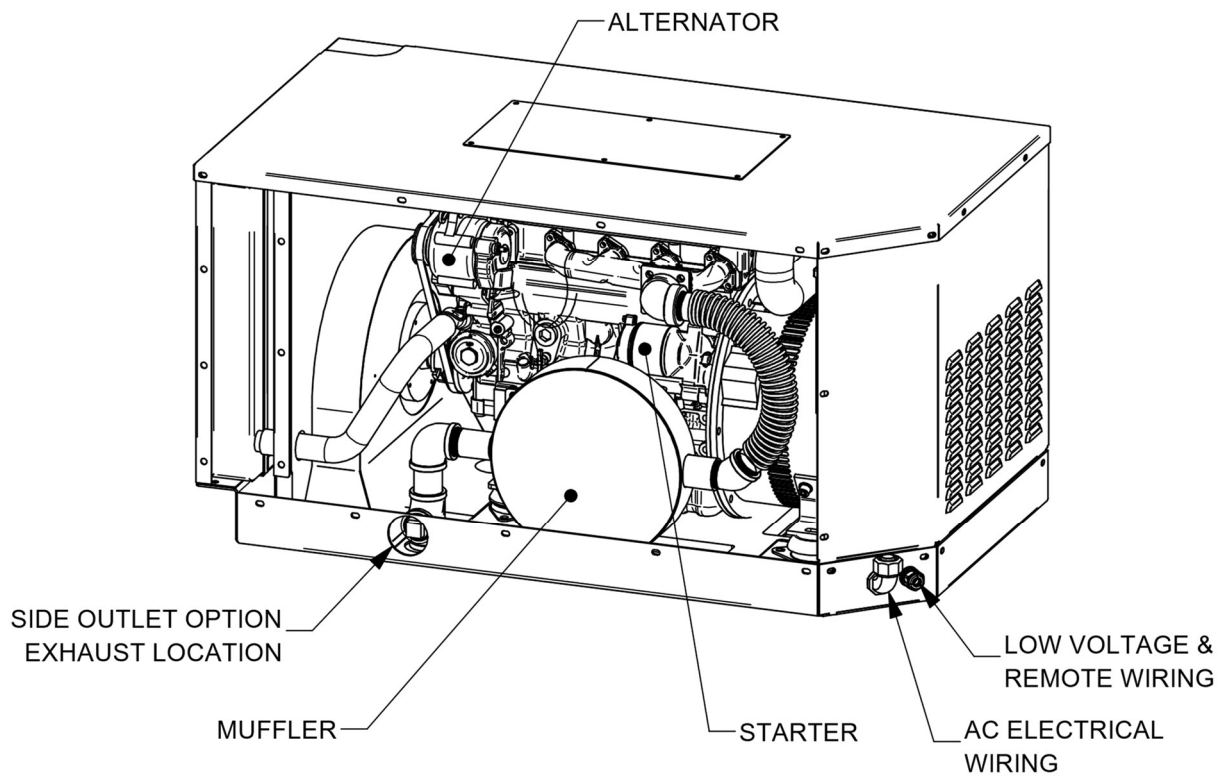
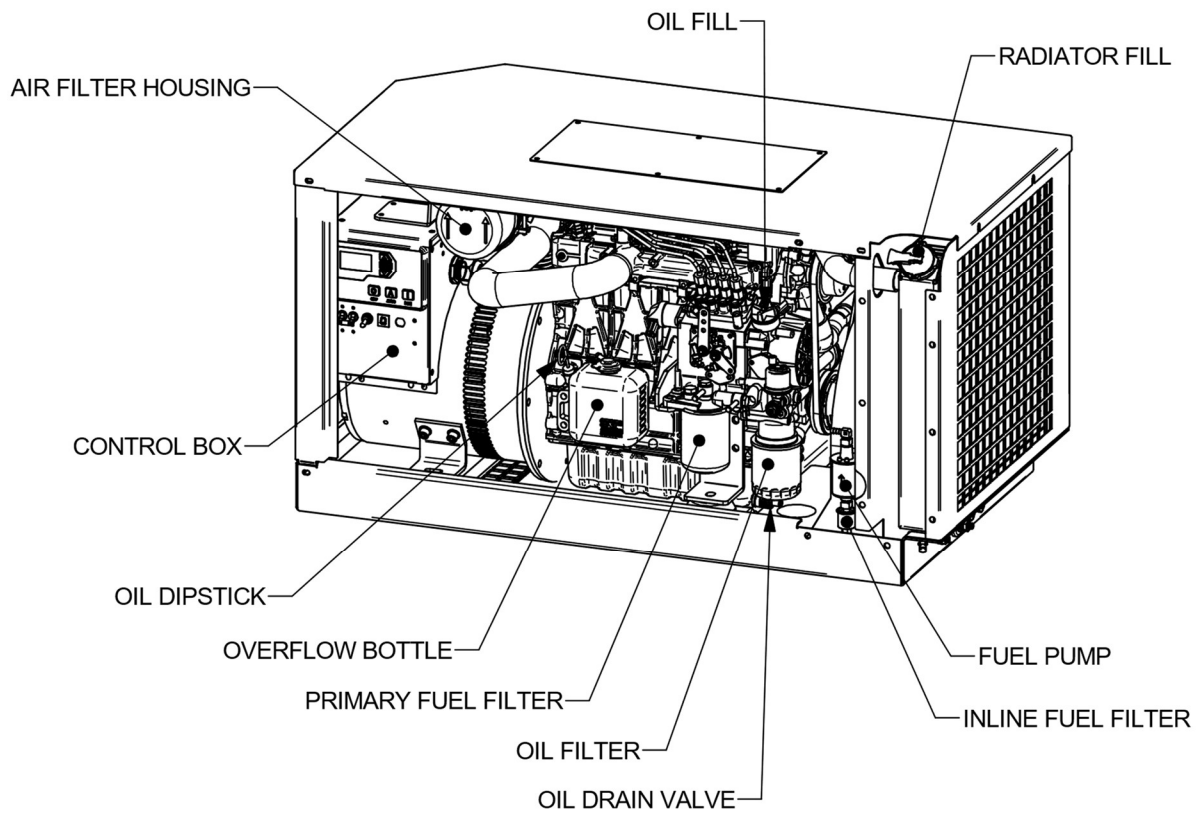

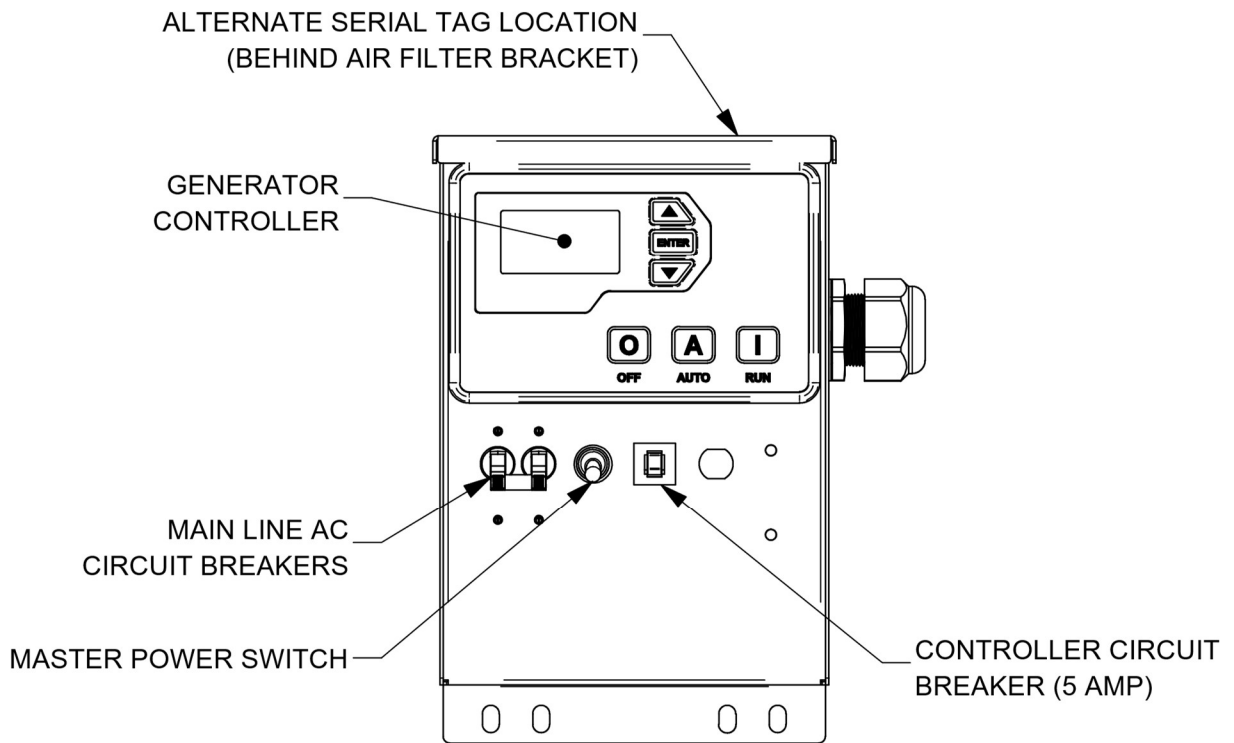
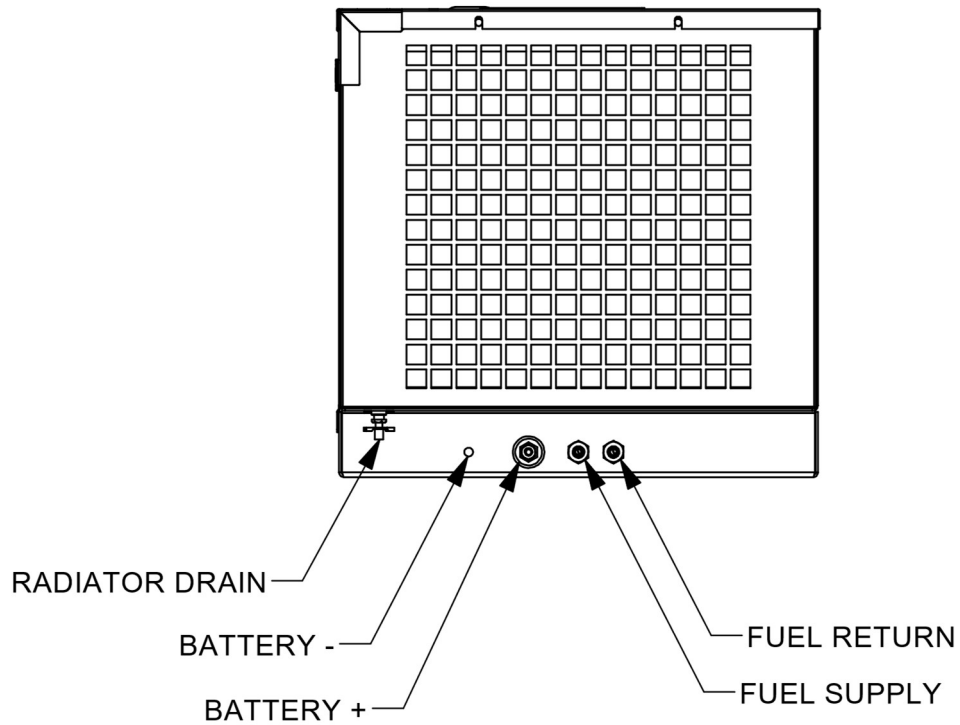

THE PTG SERIES CONTROLLER

INTRODUCTION

This generator set is equipped with Power Tech's advanced PTG series electronic generator controller. The PTG series controller provides manual and remote starting capability, as well as, other options such as auto start on low battery and generator exercising. In addition to starting and shutting down the generator set, the PTG controller monitors and displays engine and generator parameters, such as, operating hours, engine speed, engine temperature, oil pressure, battery voltage, generator voltage and frequency. The PTG series controller is also capable of displaying and storing Diagnostic Trouble Codes (DTC) and faults.

INTERFACE

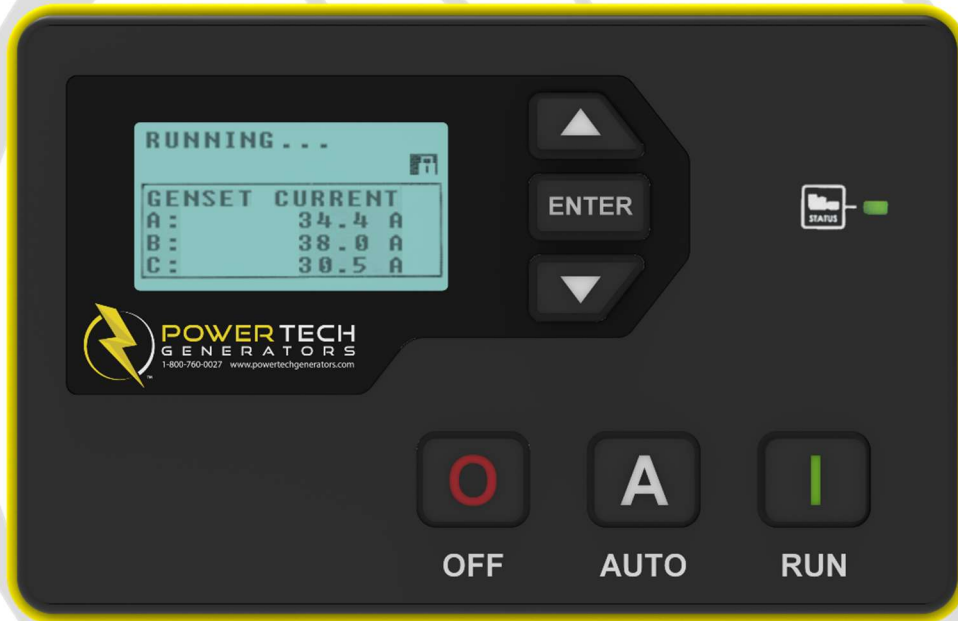

LCD Display

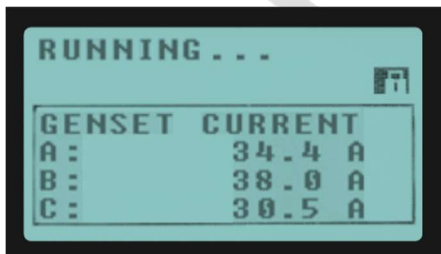

The LCD display is the primary source of information on the controller. The LCD display allows you to view and change settings, monitor engine sensors, and monitor generator output.

LED Status Light









In addition to the LCD Display, the PTG series controller also has a Status LED on the front face. The Status LED color changes to show the status of the generator set.

- Green = Engine running with no issues
- Amber = Engine running with one or more warnings
- Red = Engine shut down for a failure

Buttons

The PTG series controller is controlled by the 6 buttons on the front face. The function of each buttons is described in the following chart.

Item	Name	Description
	OFF Button	Used for turning off the generator set or exiting out of AUTO mode. NOTE: The OFF button is not intended to function as an Emergency Stop. There are conditions in which it will not shutdown the generator set.
	AUTO Button	Used for placing the controller into AUTO mode. Once in AUTO mode the controller waits for a start command to be received.
	RUN Button	Used to start the engine manually. The OFF button must be used to shut down the engine if manually started from front panel.
	UP Button	Used for moving around in the menu, changing a settings value, or changing the currently displayed parameter page.
	ENTER Button	Used for entering the menu system, accepting settings, or locking the LCD screen when viewing parameters.
	DOWN Button	Used for moving around in the menu, changing a settings value, or changing the currently displayed parameter page.

Modes

The following table describes the different operating modes of the controller:

Mode / State	Description
OFF	When in the OFF mode, the generator set is shutdown and cannot be remotely started. The generator set can be started manually from the local controller.
AUTO	When in the AUTO mode, the controller waits to receive an external start signal from a remote panel, transfer switch or other device.
RUNNING	When the generator set is running, the controller monitors engine & generator parameters and waits to receive a stop command.
FAILURE	When a failure occurs, the controller shuts down the generator set and displays the reason for failure. The controller must be reset using the OFF button on the local controller. The controller cannot be reset or started from a remote source.

CONTROLLER OPERATION

Viewing Parameters

Various engine and generator parameters can be viewed on the LCD Display. The parameters will automatically scroll, but by pressing the UP or DOWN buttons you can scroll through to the information you want to see. Once on the information desired, press the ENTER button to lock the screen and prevent it from automatically scrolling. A lock icon will appear to signify that the display is locked. Press the ENTER button again to unlock it. What parameters are displayed depends on what mode the controller is in. If a parameter is highlighted, that indicates the parameter is outside the acceptable range and either a warning or fault will be displayed as well.

In OFF mode, no parameters are available.

In AUTO mode, the following parameters are available:

- Battery Voltage
- Engine Temperature
- Oil Pressure
- Engine Hours

While running, the following parameters are available:

- Battery Voltage
- Engine Temperature

- Oil Pressure
- Engine Hours (Total running time)
- Running Time (Current running time)
- Engine Speed
- AC Frequency
- Genset Voltage

Event History

The PTG series controller is capable of storing up to 150 events in the Event History. Events range from starting and stopping to warnings and failures. Information stored in the Events History may be useful in determining when the generator set was last run, why the generator set shut down, and other troubleshooting.

To access the Event History:

- Press the OFF button to put the controller in OFF mode. The controller must be in the OFF mode in order to access the Event History.
- Press the ENTER button to bring up the menu.
- Use the UP or DOWN buttons to scroll until Events History is highlighted.
- Press the ENTER button to access the Event History.
- Once in the Event History, use the UP or DOWN buttons to scroll through all the stored events.
- Press the ENTER button to exit the Event History.

Each event in the Event History entry will have the following information:

- What event number it is out of the total number of events stored. The most recent events are displayed first and with the lowest number.
- The type of event
 - EVENT = Informational items
 - WARNING = A fault that needs to be corrected but did not result in a shutdown of the generator set.
 - FAILURE = A severe fault that resulted in the shutdown of the generator set. This needs to be corrected before attempting to restart the generator set.
- A description of the event.
- The time and date the event occurred.



OPERATING THE GENERATOR SET

PRE-START

To ensure proper and reliable operation, always inspect the generator set daily and prior to each startup.

- Verify that the engine oil level is at the correct level. Add if necessary.
- Verify that the coolant is at the correct level. Add if necessary.
- Check for leaks and/or fluids in the compartment. Clean and/or repair as necessary.
- Check fuel level in tank.
- Check battery cables and terminals are secure.
- Check battery terminals for corrosion.
- Check for water in fuel and drain if necessary.
- Check the controller for DTC codes or failures.
- Verify drive belt tension is correct.
- Inspect all hoses and belts for damage or wear. Replace if necessary.
- Inspect wiring for damage, fraying, bare spots, and proper connection. Replace if necessary.
- Ensure the area around the generator set is free of loose objects and debris.
- Verify all guards and covers are in place and securely fastened.
- Ensure the Main Set AC Circuit Breaker is in the OFF position.
- Ensure the Master Power Switch is in the OFF position.

MANUALLY STARTING THE GENERATOR SET

The generator set is capable of being started automatically, remotely and from the local controller on the genset. The following steps are used to start the generator set manually from the local controller. Ensure the Pre-Start checks above have been completed before attempting to start the generator set.

1. Set the Master Power Switch to the ON position. The controller will power on and boot-up to the last start mode used.
2. Press the OFF (O) button to put the controller in MANUAL mode. The screen will display **NOT IN AUTO START ENABLED**.
3. Press the RUN (I) button to start the generator set. The screen will display a **PREHEATING** count down, a **CRANKING** countdown, and then display **MANUAL RUN..**
4. Allow the engine to warm up for 1-2 minutes.
5. Verify that all engine and generator output parameters are nominal.
6. Turn the Main Set AC Circuit Breaker to the ON position to start supplying power.
7. Continue to monitor the generator set during operation to ensure it is operating correctly.

REMOTE AND AUTO STARTING THE GENERATOR SET

If desired, the generator set is capable of being started either manually from a remote panel or automatically via an external signal from a transfer switch or other device. The following steps are used to set up the controller to accept an external start signal. Ensure the Pre-Start checks above have been completed before putting the generator set into AUTO mode.

 WARNING

Accidental start-up. Can cause severe injury or death.

! WARNING: Putting the generator set in AUTO mode may cause the generator set to start without warning. This can result in severe injury or death.

Use extreme caution when working around the generator set when it is in AUTO mode.

DO NOT service the generator set while it is in AUTO mode.

1. Set the Master Power Switch to the ON position. The controller will power on and boot-up to the last start mode used.
2. Press the AUTO (A) button to put the controller in AUTO mode. The screen will display **Waiting To Start**.
3. Turn the Main Set AC Circuit Breaker to the ON position.
4. The generator set is now ready to accept an external start signal.
5. Continue to monitor the generator set during operation to ensure it is operating correctly.

MANUALLY SHUTTING DOWN THE GENERATOR SET

The following steps are used to manually shut down the generator set.

1. Turn the Main Set AC Circuit Breaker to the OFF position.

NOTICE: **DO NOT** shut down the generator set under load. Doing so may cause damage to the generator set. Damage caused by shutting down the generator set under load is not covered under warranty.

2. Allow the generator set to cool down by letting it run for 2-3 minutes with no load.
3. Press the OFF (O) button to shut down the generator set. The screen will display an **ETS SHUTDOWN** timer.
4. Once the engine has stopped, set the Master Power Switch to the OFF position.

NOTICE: **DO NOT** shut down the generator set by setting the Master Power Switch to the OFF position while the engine is running. Doing so may cause damage to the generator set. Damage caused by shutting down the generator set by setting the Master Power Switch to the OFF position while the engine is running is not covered under warranty.

MAINTENANCE

For the longest life and reliable operation, it is important that the generator set is maintained periodically according to the factory's specifications. Maintenance should be performed in a safe and environmentally friendly manner.



Before servicing this generator, be sure to read and understand all instructions. This generator set has been designed for safe operation in a specific application. **DO NOT** modify or use this generator set for any application other than that it has been designed for. Improper usage can cause damage, injury, or death. All service work must be performed by properly trained and qualified personnel. Electrical troubleshooting, and repair should only be performed by a qualified electrician.

The following guidelines should always be obeyed.

- Read, understand and follow all safety precautions and warnings before operating the generator set.
- Be sure to read and follow all safety decals affixed to the generator set.
- **DO NOT** modify the generator set. Unauthorized modifications may affect the life of the generator set; as well as, result in injury or death.
- **DO NOT** work on machinery or equipment while under the influence of alcohol, medication, other drugs, or while fatigued.
- When making electrical repairs to the generator set, be sure to follow any local, state, and National Electric Code (NEC) guidelines.
- When performing safety checks or generator set service, be sure the generator set is level and well supported. Use only approved stands designed for this type of service.
- **DO NOT** service a generator set that is only supported by a lift jack or hoist.
- Detach the battery from the generator set before conducting any service.
- Be sure to stop and disable the generator set before conducting inspections, maintenance, servicing, and cleaning.
- Check or conduct maintenance only after the generator set has cooled off completely.
- Always use the appropriate tools when performing any service work. Be sure to understand and follow the instructions included with these tools.
- Use **ONLY** correct engine barring techniques for manually rotating the engine. **DO NOT** attempt to rotate the engine by pulling or prying on the cooling fan and V-belt. Serious personal injury or damage to the generator set may occur.
- Replace fuel hoses and hose clamps at least every 2 years, whether they look damaged or worn. They are made of rubber and gradually deteriorate from the inside out.
- When service is performed with two or more people present, always be aware of their location, especially when starting the generator set.
- Keep a first aid kit and fire extinguisher nearby at all times.

MAINTENANCE SCHEDULE

Maintenance Service Item	See notes	Daily	150 Hours	500 Hours	1000 Hours	Remarks
Check Engine Oil Level		◆				
Check Coolant Level		◆				
Check for Oil, Fuel, and Oil Leaks		◆				
Check Electrical Connections		◆				
Check Fuel Level		◆				
Check for Water in Fuel	◆	◆				
Change Engine Oil	◆		◆			At Least Every Year
Oil Filter Change			◆			At Least Every Year
Check Engine & Generator Mounts				◆		At Least Every Year
Replace Primary Fuel Filter	◆			◆		At Least Every Year
Replace In-Line Fuel Filter	◆			◆		At Least Every Year
Replace Air Filter Element	◆			◆		At Least Every Year
Replace Belts					◆	At Least Every Two Years
Change Coolant					◆	At Least Every Year
Replace Fuel Lines & Hoses					◆	At Least Every Two Years
Replace Coolant Hoses and Clamps					◆	At Least Every Year

Notes:

1. Engine Oil must be changed after the first 50 hours of service then in 150 hour intervals after the first 50 hours.
2. Filter replacement intervals may vary depending on the quality of air, fuel, etc. These service intervals are maximums and should be adjusted based on the operating conditions of the generator set.

ENGINE OIL MAINTENANCE

High quality engine oil is crucial to reliable operation and increased life expectancy of the generator set. Engine oil provides lubrication and cooling to the internal components of the engine.

Lubricating Oil Specifications

It is important to use a high quality, multi-grade engine oil designed for diesel engines. Engine oil should meet API classification of CF or higher.

The type of engine oil required changes according to the ambient temperature. Refer to the Engine Oil Viscosity Table below in order to determine the oil viscosity for engine operation at the ambient temperature range that is anticipated.

Above 77°F (25°C)	SAE 10W-30 or 10W-40 or 15W-40
14° to 77° F (-10°C to 25°C)	SAE 10W-30 or 10W-40 or 15W-40
Below 14°F (-10°C)	SAE 10W-30 or 10W-40

Note: The factory uses and recommends the use of a high-quality SAE 15W-40 diesel engine oil.

NOTICE: The use of low quality, incorrect viscosity, and/or oils not designed for diesel engine applications may result in increased engine wear or engine seizure. Damage caused by using incorrect engine oil is not covered under warranty.

Checking the Engine Oil Level

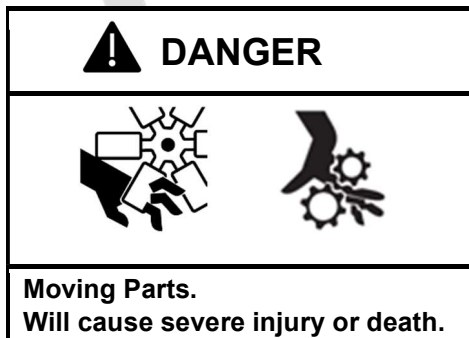

During operation, some parts of the generator set can become extremely hot. To avoid burns, allow the engine to cool sufficiently before checking the engine oil.



Always stop the engine before checking the engine oil. **DO NOT** check the engine oil while the engine is running.

Always put the generator set in OFF mode before checking the oil. If the generator set is in AUTO mode, the generator set may start automatically, without warning.

1. Shut down the generator set and put it in OFF mode.
2. Ensure the generator set is on a level surface. If the generator set is on a grade, the oil level measurement may be incorrect.
3. Allow the generator set to sit for at least 5 minutes to allow the generator set to cool and allow oil to flow back to the oil pan.
4. Remove the dip stick, wipe it clean, and replace it.
5. Remove the dip stick again and observe the oil level. The oil should be between the ADD & FULL marks.

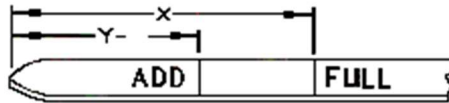

6. If necessary, remove the oil cap and add new oil to bring the oil up to the correct level.
7. Replace the dip stick and oil fill cap, if removed.

Changing the Engine Oil and Filter

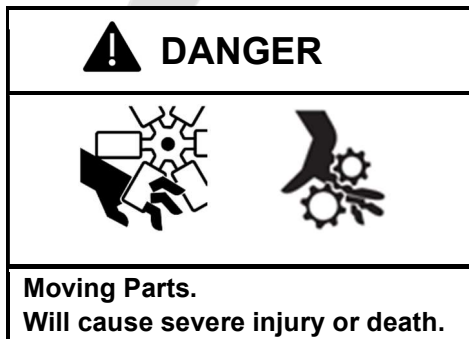

During operation, some parts of the generator set can become extremely hot. To avoid burns, allow the engine to cool sufficiently before changing the engine oil.



Always stop the engine before changing the engine oil. **DO NOT** change the engine oil while the engine is running.

Always put the generator set in OFF mode before changing the oil. If the generator set is in AUTO mode, the generator set may start automatically, without warning.

1. Shut down the generator set and put it in OFF mode.
2. Ensure the generator set is on a level surface and properly supported.
3. Allow the generator set to sit for at least 5 minutes to allow the generator set to cool and allow oil to flow back to the oil pan.
4. Drain the oil using one of the following methods:
 - Using the oil drain plug
 - Remove the oil drain plug from the bottom of the oil pan and drain old oil into an appropriate container.
 - Reinstall the oil drain plug.
 - Using the oil drain valve
 - Install a 3/8" hose over the nipple on the end of the drain valve and route hose out the bottom of the enclosure into an appropriate container.
 - Lift the lever and rotate it towards the nipple.

- Close the drain valve by rotating the lever back to the closed position making sure the lever snaps back down into the detent.

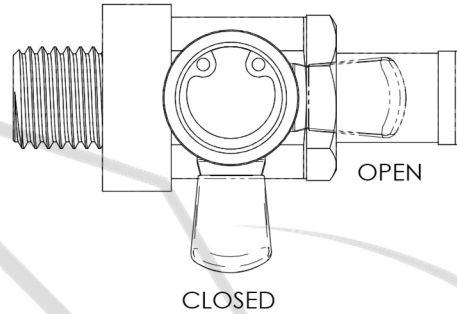

- Using a filter wrench, remove the old oil filter. Ensure the oil filter gasket does not remain.
- Apply a thin film of oil to the gasket on the new oil filter.
- Screw the new oil filter on and tighten by hand. **DO NOT** use a wrench to tighten the oil filter.
- Remove the oil fill cap, add new engine oil to bring the oil up to the correct level, and replace cap.
- Clean up any spilled oil.
- Dispose of old engine oil and filter according to local regulations.

COOLING SYSTEM MAINTENANCE



The cooling system circulates coolant through the engine where it absorbs excess heat from the engine. The coolant then flows through the radiator where this waste heat is exhausted to the atmosphere. Proper maintenance will help prolong the life of your generator set.

Coolant Specifications

It is important to use a high-quality engine coolant. Engine coolant comes in several types. The use of 50/50 mix of an ethylene glycol type of coolant and clean, soft water is recommended for use in this generator set. The use of proper coolant helps prevent freezing, boil over, and corrosion.

Coolant Mix (Antifreeze to Water)	Freezing Point		Boiling Point	
	°F	°C	°F	°C
50/50	-34	-37	226	108

Checking the Coolant

 WARNING	 WARNING	 DANGER
		
Hot Engine and Exhaust System Can cause severe injury or death.	Hot Coolant and Steam Can cause severe injury or death.	Moving Parts. Will cause severe injury or death.

During operation, some parts of the generator set can become extremely hot. To avoid burns, allow the engine to cool sufficiently before checking the coolant level. **DO NOT** remove the radiator cap while the radiator is hot. Doing so could result in extremely hot coolant spraying out. Severe burns may result.









Always stop the engine before checking the coolant level. **DO NOT** check the coolant level while the engine is running.

Always put the generator set in OFF mode before checking the coolant level. If the generator set is in AUTO mode, the generator set may start automatically, without warning.

1. Shut down the generator set and put it in OFF mode.
2. Ensure the generator set is on a level surface and properly supported.
3. Allow the generator set to cool fully.
4. Remove the thumbscrews to remove the Radiator Coolant Access Panel from the enclosure.
5. Carefully open the radiator cap, allowing any pressure to vent before removing.
6. The coolant level should be at the base of the fill neck.
7. If necessary, add 50/50 mix to bring the coolant up to the appropriate level.
8. Replace the radiator cap, ensuring it is tight.
9. Check the overflow bottle.
10. The coolant level should be between the FULL and LOW marks.
11. If necessary, add 50/50 mix to bring the coolant up to the appropriate level.



Changing the Coolant

 WARNING	 WARNING	 DANGER
		
Hot Engine and Exhaust System Can cause severe injury or death.	Hot Coolant and Steam Can cause severe injury or death.	Moving Parts. Will cause severe injury or death.

During operation, some parts of the generator set can become extremely hot. To avoid burns, allow the engine to cool sufficiently before changing the coolant. **DO NOT** remove the radiator cap while the radiator is hot. Doing so could result in extremely hot coolant spraying out. Severe burns may result.





Always stop the engine before changing the coolant. **DO NOT** change the coolant while the engine is running.

Always put the generator set in OFF mode before changing the coolant. If the generator set is in AUTO mode, the generator set may start automatically, without warning.

1. Shut down the generator set and put it in OFF mode.
2. Ensure the generator set is on a level surface and properly supported.
3. Allow the generator set to cool fully.
4. Carefully open the radiator cap, allowing any pressure to vent before removing.
5. Open the radiator drain on the bottom of the radiator and drain old coolant into an appropriate container.
6. Drain the overflow bottle and refill.
7. Check all hoses and hose clamps. Replace if necessary.
8. Close radiator drain and refill radiator with appropriate coolant.
9. Replace the radiator cap, ensuring it is tight.
10. Clean up any spilled coolant.
11. Dispose of old coolant according to local regulations.



Cleaning the Radiator Core

 DANGER
 
Moving Parts. Will cause severe injury or death.

 WARNING

Hot Engine and Exhaust System Can cause severe injury or death.

During operation, some parts of the generator set can become extremely hot. To avoid burns, allow the engine to cool sufficiently before cleaning the radiator core.



Always stop the engine before cleaning the radiator core. **DO NOT** clean the radiator core while the engine is running.

Always put the generator set in OFF mode before cleaning the radiator core. If the generator set is in AUTO mode, the generator set may start automatically, without warning.

Due to the large volume of air flowing across the radiator, debris may be pulled into the radiator, clog the fins, and reduce air flow. Reduced air flow across the radiator reduces the cooling efficiency of the radiator and may cause the generator set to run hotter or overheat. Periodic cleaning of the radiator core is recommended to ensure proper air flow.

Visually inspect the core for any obstructions, such as dirt or other foreign objects. Use running water to flush debris from between the fins.

NOTICE: DO NOT use hard objects to clean the radiator core. **DO NOT** use high pressure water to clean the radiator core. Damage to radiator could result. Radiator damage caused by improper cleaning is not covered under warranty.



FUEL SYSTEM MAINTENANCE

The fuel system pulls diesel fuel from the fuel tank, filters out water and other contaminants, then conveys it to the engine for combustion. Unused fuel is returned to the fuel tank through a return line. To prevent engine damage and excess wear, the use of proper fuels and proper fuel system maintenance is required.

Fuel Pump

The fuel pump installed on the generator set from the factory is capable of supplying enough fuel to the engine in a wide range of applications; however, installations with long fuel line runs and/or fuel tanks located too far below the generator set may require the use of a secondary fuel pump (not provided).

Fuel Lines

The fuel lines connecting the generator set needs to be a high quality, diesel & oil resistant, multi-layer rubber hose. The hoses should also be resistant to temperatures of at least 212° F (100° C).

To provide an adequate supply of fuel to the engine, the hoses need to be sized appropriately.

Supply Line Size	Minimum 5/16" (8mm)
Return Line Size	Minimum 3/16" (5mm)

Fuel Specifications

It is recommended to run a clean, high quality diesel fuel with a minimum cetane rating of 50 in the generator set. The engine can operate on diesel fuels with a sulfur content up to 1.0% (10000 ppm); however, when using high sulfur fuels, with a sulfur content between 0.50% (5000 ppm) and 1.0% (10000 ppm), the engine oil and oil filter change interval is halved. **DO NOT** operate the engine on fuels with a sulfur rating greater than 1.0% (10000 ppm).

NOTICE: Always use diesel fuel. **DO NOT** use alternative fuels, such as bio-diesel or kerosene. Damage to the engine may result. Damage caused by using improper fuels is not covered under warranty.

NOTICE: The type of diesel fuel and sulfur content used **MUST** be compliant with all applicable emissions requirements in the area in which the generator set will be operated.

Bleeding the Fuel System

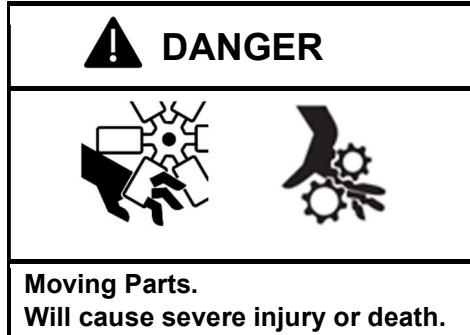

During operation, some parts of the generator set can become extremely hot. To avoid burns, allow the engine to cool sufficiently before bleeding the fuel system.



Always stop the engine before bleeding the fuel system. **DO NOT** bleed the fuel system while the engine is running.

Always put the generator set in OFF mode before bleeding the fuel system. If the generator set is in AUTO mode, the generator set may start automatically, without warning.

Air can get into the fuel system many ways including if the fuel tank has been run dry, fuel lines have been removed, the fuel filter has been removed, or the generator set has not been used for an extended time. If air has become trapped in the fuel system, use the following steps to bleed the fuel system.

1. Shut down the generator set and put it in OFF mode.
2. Ensure the generator set is on a level surface and properly supported.
3. Allow the generator set to cool fully.
4. Ensure the fuel tank is full of clean diesel fuel.
5. Disconnect the power leads from the fuel pump.
6. Connect a 12VDC source to the fuel pump leads to power the pump. You will hear the fuel pump run.
7. Allow the pump to run until the system is primed.
8. Disconnect the 12VDC source from the fuel pump.
9. Reconnect the power leads to the fuel pump.



Changing the Fuel Filters

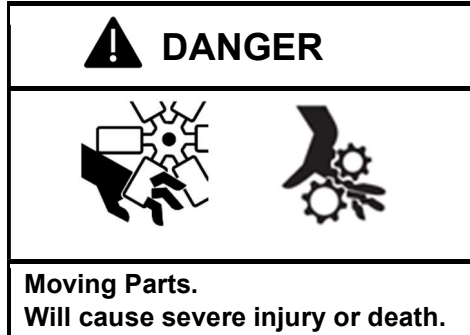

During operation, some parts of the generator set can become extremely hot. To avoid burns, allow the engine to cool sufficiently before changing the fuel filters.



Always stop the engine before changing the fuel filters. **DO NOT** change the fuel filters while the engine is running.

Always put the generator set in OFF mode before changing the fuel filters. If the generator set is in AUTO mode, the generator set may start automatically, without warning.

Water, dirt, and other contamination in the fuel can cause the engine to not operate properly, increase wear and/or engine damage. The fuel filters trap these contaminants before they reach the engine. Periodic replacement of the fuel filters is required according to the manufacturer's schedule. Use the following steps to replace the fuel filters.

Primary Fuel Filter Replacement

1. Shut down the generator set and put it in OFF mode.
2. Ensure the generator set is on a level surface and properly supported.
3. Allow the generator set to cool fully.
4. Unscrew the filter cartridge from the filter boss, ensuring the old gasket does not remain behind.
5. Apply a thin film of clean diesel fuel to the gasket on the new filter.
6. Screw on the new fuel filter cartridge and tighten by hand. **DO NOT** use a wrench to tighten the filter.
7. Bleed the air from the fuel system.
8. Clean up any spilled fuel.
9. Dispose of the old filter according to local regulations.

Inline Fuel Filter Replacement

1. Shut down the generator set and put it in OFF mode.
2. Ensure the generator set is on a level surface and properly supported.
3. Allow the generator set to cool fully.
4. Unbolt the fuel pump and filter assembly from the fan shroud.
5. Loosen the hose clamp and remove the lower fuel hose from the barb on the filter.
6. Unscrew the filter from the inlet of the fuel pump.
7. Carefully remove the hose barb from the filter and save.
8. Being careful not to get any inside the filter opening, apply a small amount of diesel safe pipe sealant to the threads on the new filter and hose barb removed earlier. **DO NOT** use Teflon tape.





9. Screw the hose barb on to the filter and tighten. **DO NOT** over tighten.
10. Screw the filter and hose barb assembly on to the inlet side of the pump and tighten. **DO NOT** over tighten.
11. Inspect fuel hose and clamp. Replace if necessary.
12. Reattach the fuel hose and clamp to the hose barb.
13. Bolt the fuel pump and filter assembly back into position.
14. Bleed the air from the fuel system.
15. Clean up any spilled fuel.
16. Dispose of the old filter according to local regulations



AIR INTAKE SYSTEM MAINTENANCE

The air intake system pulls in outside air, filters out contaminants, and supplies it to the engine for combustion. Changing of the intake air filter is required to prevent engine damage and excess wear.

Changing the Intake Air Filter

 DANGER

Moving Parts. Will cause severe injury or death.

 WARNING

Hot Engine and Exhaust System Can cause severe injury or death.

During operation, some parts of the generator set can become extremely hot. To avoid burns, allow the engine to cool sufficiently before changing the intake air filter.



Always stop the engine before changing the intake air filter. **DO NOT** change the intake air filter while the engine is running.

Always put the generator set in OFF mode before changing the intake air filter. If the generator set is in AUTO mode, the generator set may start automatically, without warning.

1. Shut down the generator set and put it in OFF mode.
2. Ensure the generator set is on a level surface and properly supported.
3. Allow the generator set to cool fully.
4. Loosen the clamp that retains the air filter housing cap and remove the clamp.
5. Remove the air filter housing cap.
6. Remove the old air filter element.
7. Wipe out any debris from the inside of the air filter housing. **DO NOT** to allow any debris to get into the rest of the air intake system. This may result in engine damage.
8. Install the new filter element ensuring it is properly seated into the housing.
9. Reinstall the air filter housing cap and secure with the clamp
10. Dispose of the old filter element responsibly.



SERVICE LOG

This service log is provided to assist you in keeping track of services performed on the generator set.

Date	Hours	Service Performed

BASIC TROUBLESHOOTING

TROUBLE	POSSIBLE CAUSE	SUGGESTED ACTION
Generator will not start from remote panel or other external source	Controller is not in AUTO mode	Put controller in AUTO mode by pressing the AUTO (A) button on the local controller
	Remote connection plug is not connected	Check remote control plug is plugged in
	Remote connection harness is damaged	Check remote connection harness for damage, repair or replace if necessary
Engine does not crank from local controller	Battery is low or terminals are dirty.	Clean terminals and re-charge battery. Replace battery if necessary.
	Crank circuitry wiring improperly connected.	Refer to engine control wiring and check crank connections.
Engine cranks but doesn't start	Out of fuel.	Check fuel level, add fuel if necessary.
	Fuel relay damaged	Check fuel relay and replace if damaged.
	Fuel system lost prime	Reprime fuel system
Engine Starts but shuts down after a few seconds	See failure on controller LCD Display	
Engine Starts but genset not producing voltage	Main breaker is in the OFF position	Turn Main Breaker to the ON position
	Output leads damaged or disconnected	Visually inspect all output leads; repair or replace if necessary

If following these steps do not resolve your issue or for additional trouble shooting assistance & information, please contact one of our service dealers or our Customer Service Department.

WIRING DIAGRAMS

120/240 VAC – A TYPE GENERATOR END WITH AS440 AVR

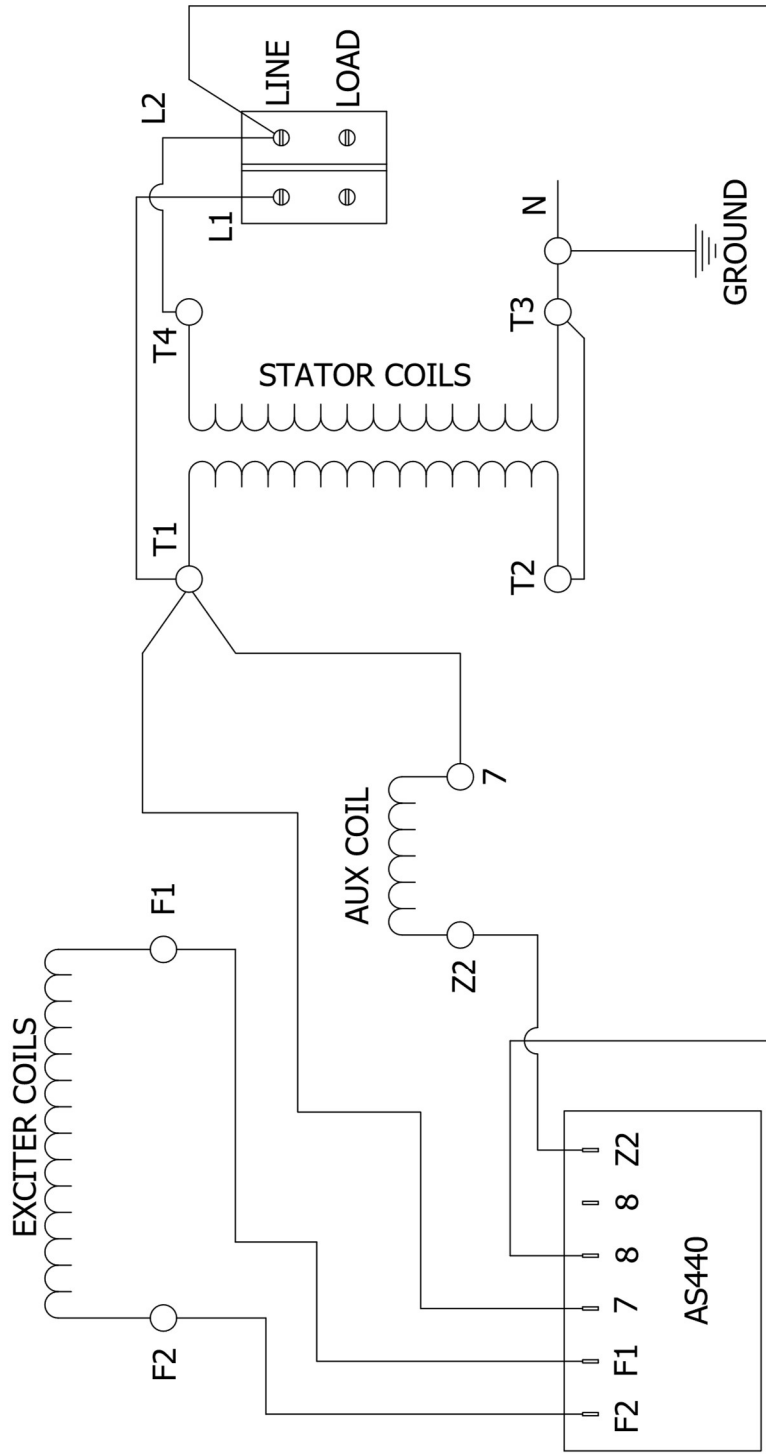

120VAC ONLY- CE TYPE GENERATOR END WITH VR3.1B AVR

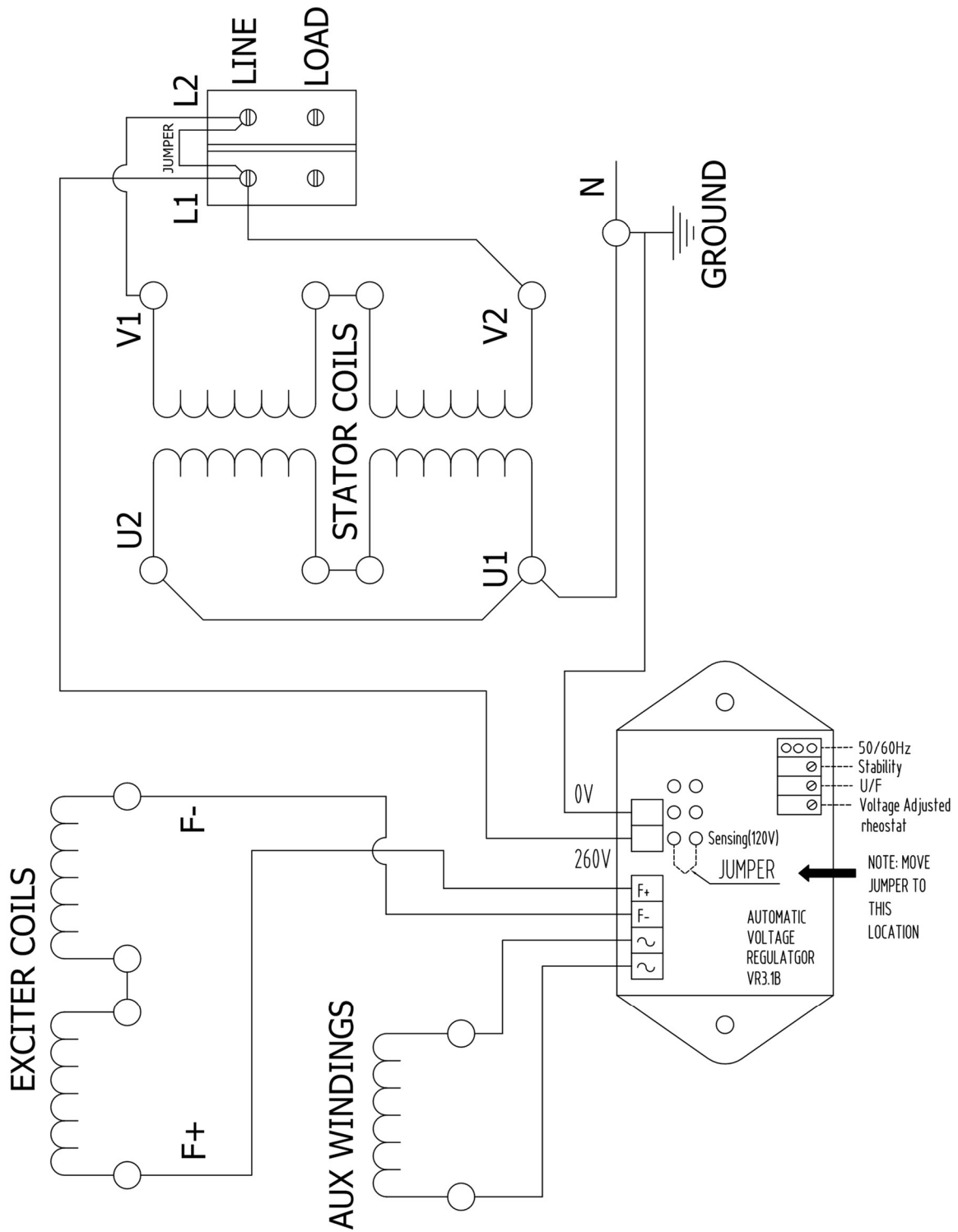

120/240VAC – CE TYPE GENERATOR END WITH VR3.1B AVR

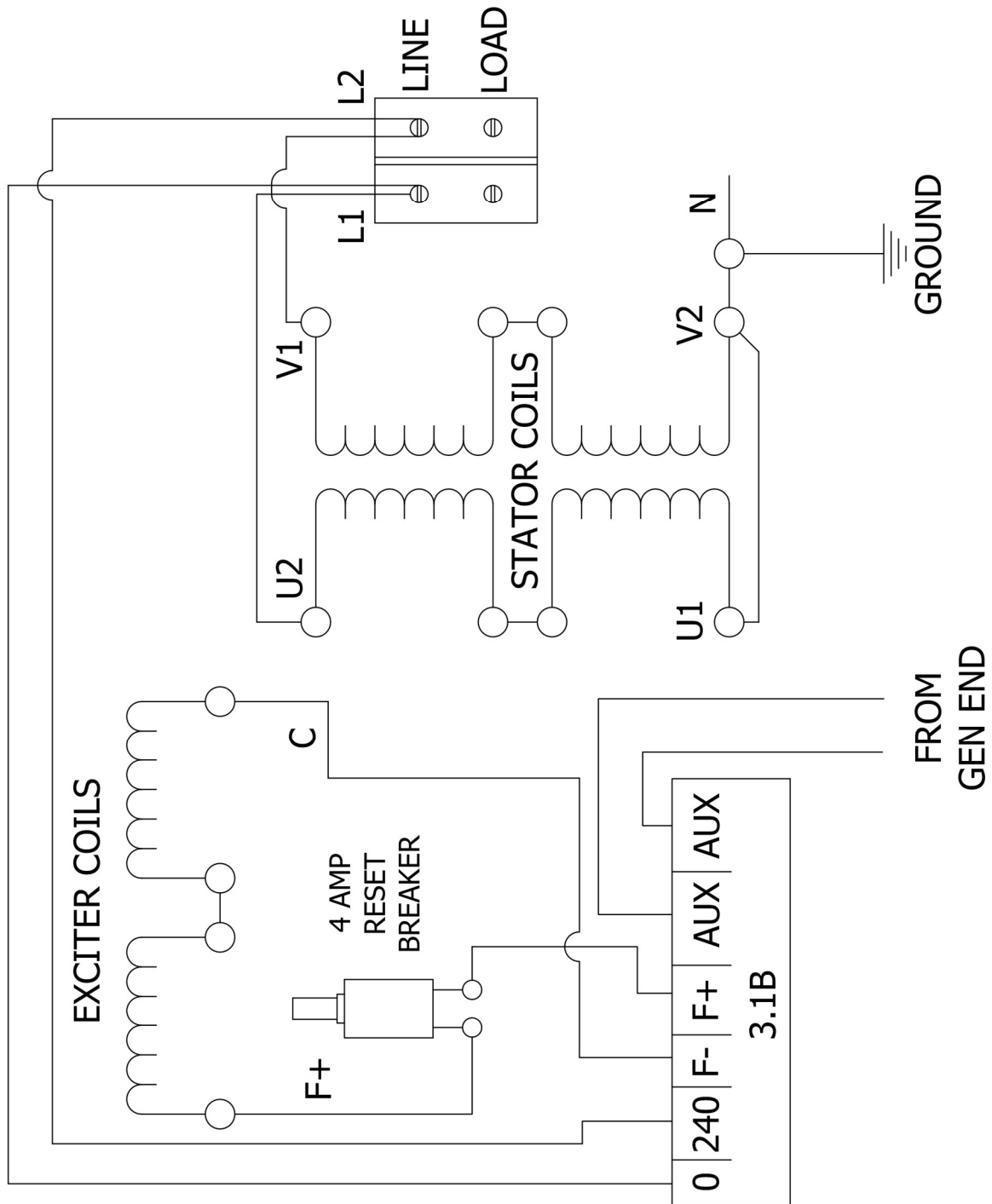

CONTROL WIRING WITH PTG350 CONTROLLER

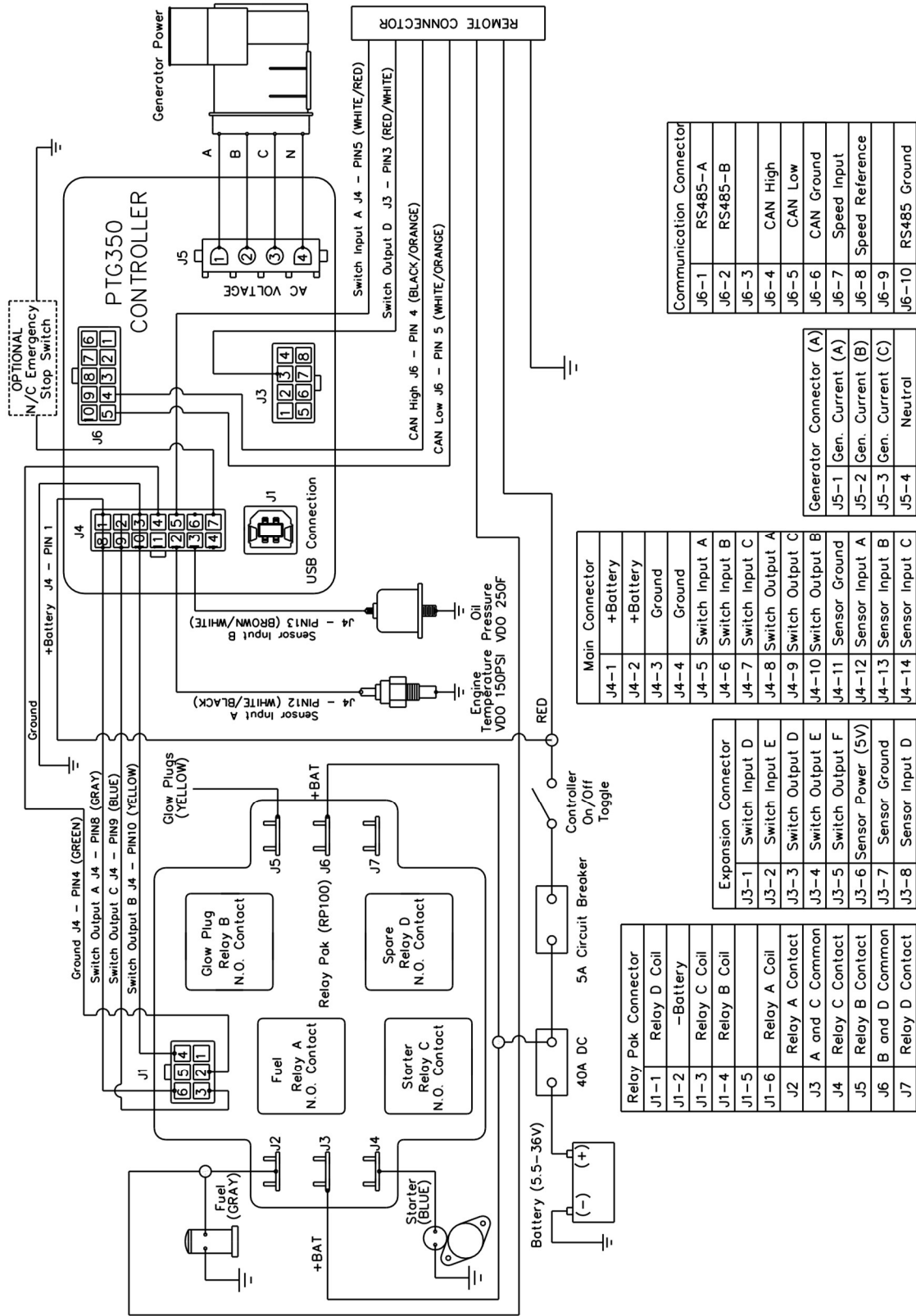

REVISIONS

Revision	Date
Initial Release	2/5/2020