



LED HID REPLACEMENT : LARGE

DESCRIPTION

LED HID Replacement Lamps are an ideal alternative to high-watt HID lamps, consuming up to 80% less energy and delivering an impressive 130+ lumens per watt.

FEATURES

- Universal mounting position
- Lasts 3x longer than metal halide or HPS HID lamps
- Eliminates maintenance costs for over 10 years; no expensive HID lamps or ballasts to replace
- Shatter resistant for reduced risk of injury or breakage
- Integral driver; eliminates the need for external driver or ballast
- Built-in 5kV surge protection
- Environmentally friendly: contains no glass, mercury, or lead

WARRANTY

- 5 year limited warranty; see eiko.com for warranty details

APPLICATIONS

- Industrial
- Commercial
- Post-Tops
- Shoebox Fixtures
- High Bay
- Cobra Head



80W
EX39

100W
EX39

120W
EX39



PERFORMANCE	Power Consumption	80W	100W	120W
	Lumens	10,400-10,800	12,800-13,500	15,600-15,840
	Efficacy (LPW)	130-135	130-135	130-132
	CRI	80+		
	Beam	Omnidirectional		
	CCT	4000K, 5000K		
	Life (L70)	50,000 hours		
ELECTRICAL	Power Factor	≥0.9		
	Input Voltage	120-277V; 347		
CONSTRUCTION	Operating Temperature	-4°F - 122°F (-20°C - 50°C)		
	Base	EX39		
LISTINGS	Certification(s)	DesignLights Consortium® Qualified; cULus Classified		
	Material Usage	RoHS Compliant; no mercury		
	Environment	IP64 Rated; Suitable for use in enclosed fixtures		

PERFORMANCE SUMMARY

MOGUL BASE (EX39):

Order Code	Item #	Lumens	Watts	LPW	CCT	CRI	Volts	Life/Hours	Replaces HID	DLC
09827	LED80WPT40KMOG-347V-G8	10,400	80W	130	4000K	80+	347	50,000	320W	✓
10260	LED80WPT40KMOG-G8	10,400	80W	130	4000K	80+	100-277	50,000	320W	✓
09828	LED80WPT50KMOG-347V-G8	10,800	80W	135	5000K	80+	347	50,000	320W	✓
10261	LED80WPT50KMOG-G8	10,560	80W	132	5000K	80+	100-277	50,000	320W	✓
10254	LED100WPT30KMOG-G8	12,800	100W	128	3000K	80+	100-277	50,000	400W	✓
09825	LED100WPT40KMOG-347V-G8	13,000	100W	130	4000K	80+	347	50,000	400W	✓
10255	LED100WPT40KMOG-G8	13,000	100W	130	4000K	80+	100-277	50,000	400W	✓
09826	LED100WPT50KMOG-347V-G8	13,500	100W	135	5000K	80+	347	50,000	400W	✓
10256	LED100WPT50KMOG-G8	13,200	100W	132	5000K	80+	100-277	50,000	400W	✓
10258	LED120WPT40KMOG-G8	15,600	120W	130	4000K	80+	100-277	50,000	600W	✓
10259	LED120WPT50KMOG-G8	15,840	120W	132	5000K	80+	100-277	50,000	600W	✓

NOTE: Use order code when ordering. ✓DesignLights Consortium® Qualified

DIMENSIONS

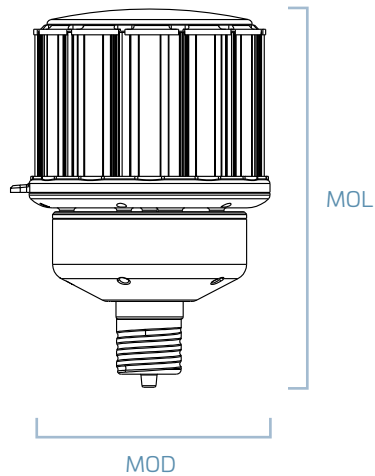

	100-277V	
Size (Wattage)	MOL	MOD
80W	9.21"/234mm	5.87"/149mm
100W	9.57"/243mm	5.87"/149mm
120W	10.35"/263mm	5.87"/149mm

	347V	
Size (Wattage)	MOL	MOD
80W	11.61"/295mm	5.12"/130mm
100W	12.8"/325mm	5.12"/130mm