

PA-17 Data Sheet



Contents

Specifications	2
Dimensions	3
Speed/Current vs Load	4-5
Connectors & Feedback	6-7
Internal Components	8
Internal Descriptions	9

Specifications



Load (LBS)		No Load Current (A)				Full Load Current (A)				Speed (inch/sec)	
Dynamic	Static	12VDC	24VDC	36VDC	48VDC	12VDC	24VDC	36VDC	48VDC	No Load	Full Load
450	900	3.5	1.8	1.2	0.9	20.0	10.0	6.7	5.0	1.50	1.12
850	1700	3.5	1.8	1.2	0.9	20.0	10.0	6.7	5.0	0.66	0.55
2000	4000	3.5	1.8	1.2	0.9	20.0	10.0	6.7	5.0	0.33	0.27

Input Voltage	12VDC, 24VDC, 36VDC, 48VDC
Stroke	1" to 40"
Feedback	None, Potentiometer, Hall Effect
Duty Cycle	25%
Weather Protection	IP65
Overload Protection	Mechanical Slip Clutch
Operational Temperature	-25°C to 65°C (-13°F to 149°F)
Operating Noise	<45 dBA
Limit Switch	Built-In (Adjustable) - Max 24" Stroke Length
Cable Length	40" (Customizable)
Connector	See Page 6 (Customizable)
Front Mounting Hole Size	0.50" (Customizable)
Rear Mounting Hole Size	0.50" (Customizable)
Actuator Type	Industrial
Motor Type	Brushed DC Motor
Screw Type	ACME
Stroke Rod Material	Stainless Steel 304
Housing Material	Stainless Steel
Gear Material	Powder Metallurgy Steel Alloy
Certifications	CE, RoHS
Compatible Mounting Brackets	BRK-17
Warranty	18 Months



Dimensions

(Dimensions in inches)

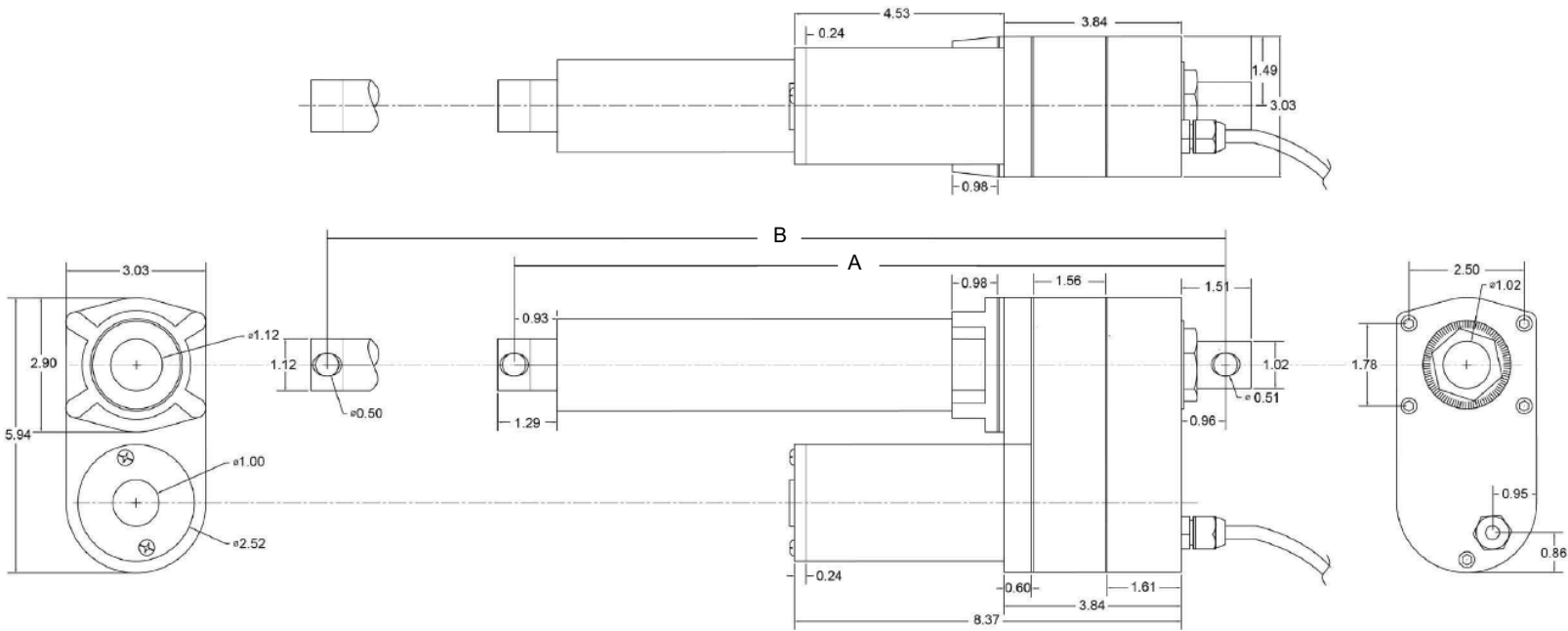

Hole to Hole

PA-17	Stroke	1	2	3	4	6	8	9	10	12	14	16	18	20	22	24	30	40
	A	10.87	11.87	12.87	13.87	15.87	17.87	18.87	19.87	21.87	23.87	25.87	27.87	29.87	31.87	33.87	41.87	51.87
B	11.87	13.87	15.87	17.87	21.87	25.87	27.87	29.87	33.87	37.87	41.87	45.87	49.87	53.87	57.87	71.87	91.87	

For Stroke Length ≤ 24"

A = Stroke Length + 9.87"

B = Stroke Length x 2 + 9.87"

Stroke Lengths over 24"

A = Stroke Length + 11.87"

B = Stroke Length x 2 + 11.87"



Speed vs Load

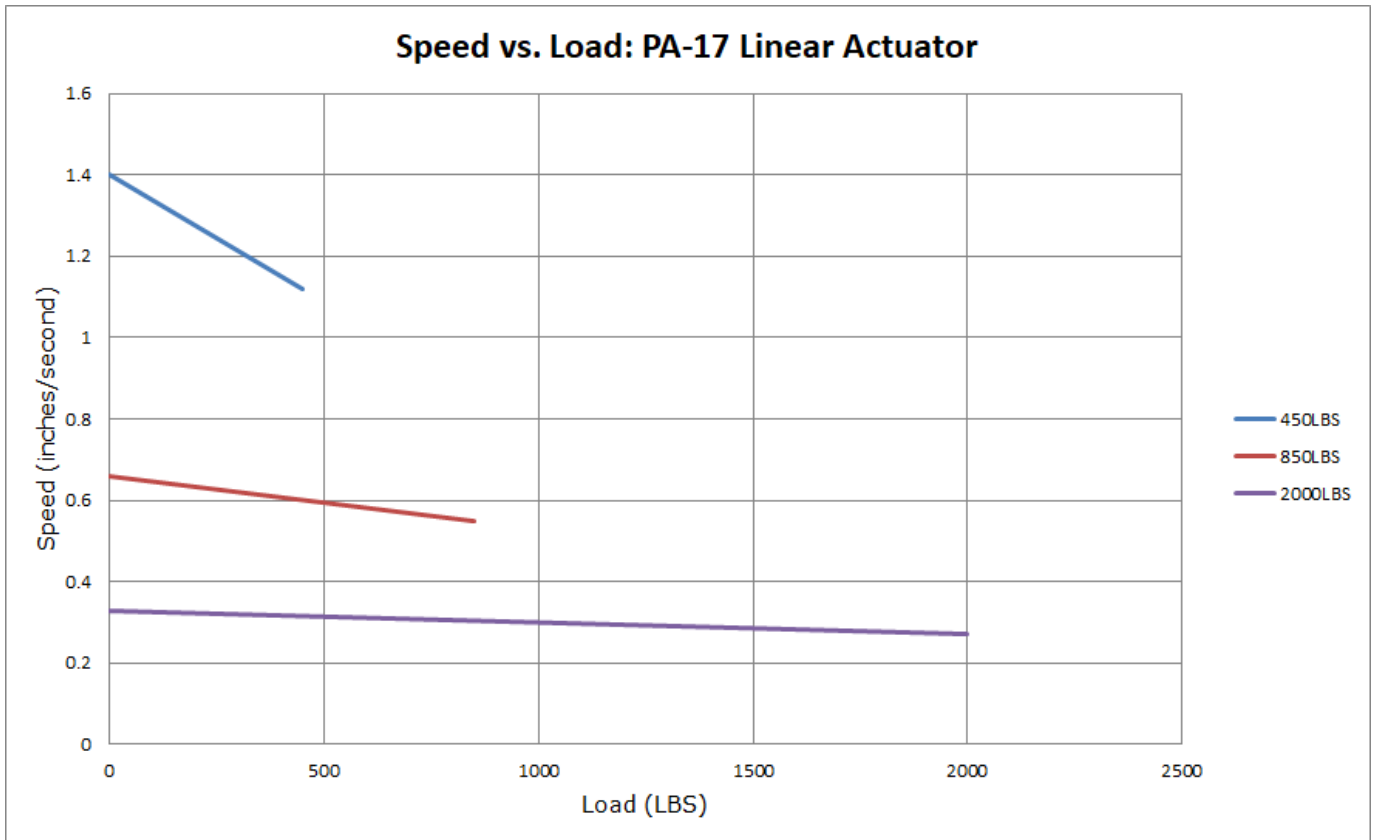

Current vs Load

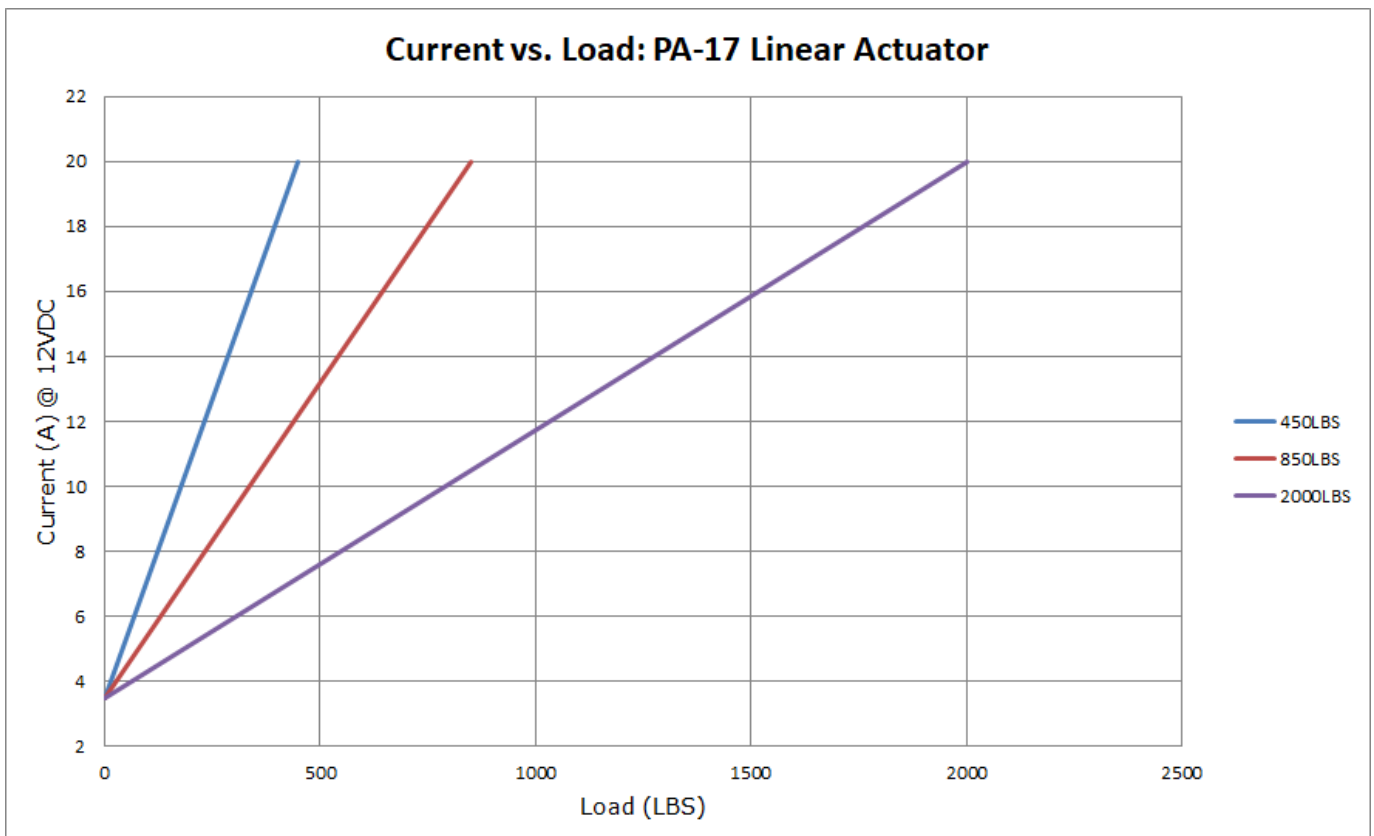



Current vs Load

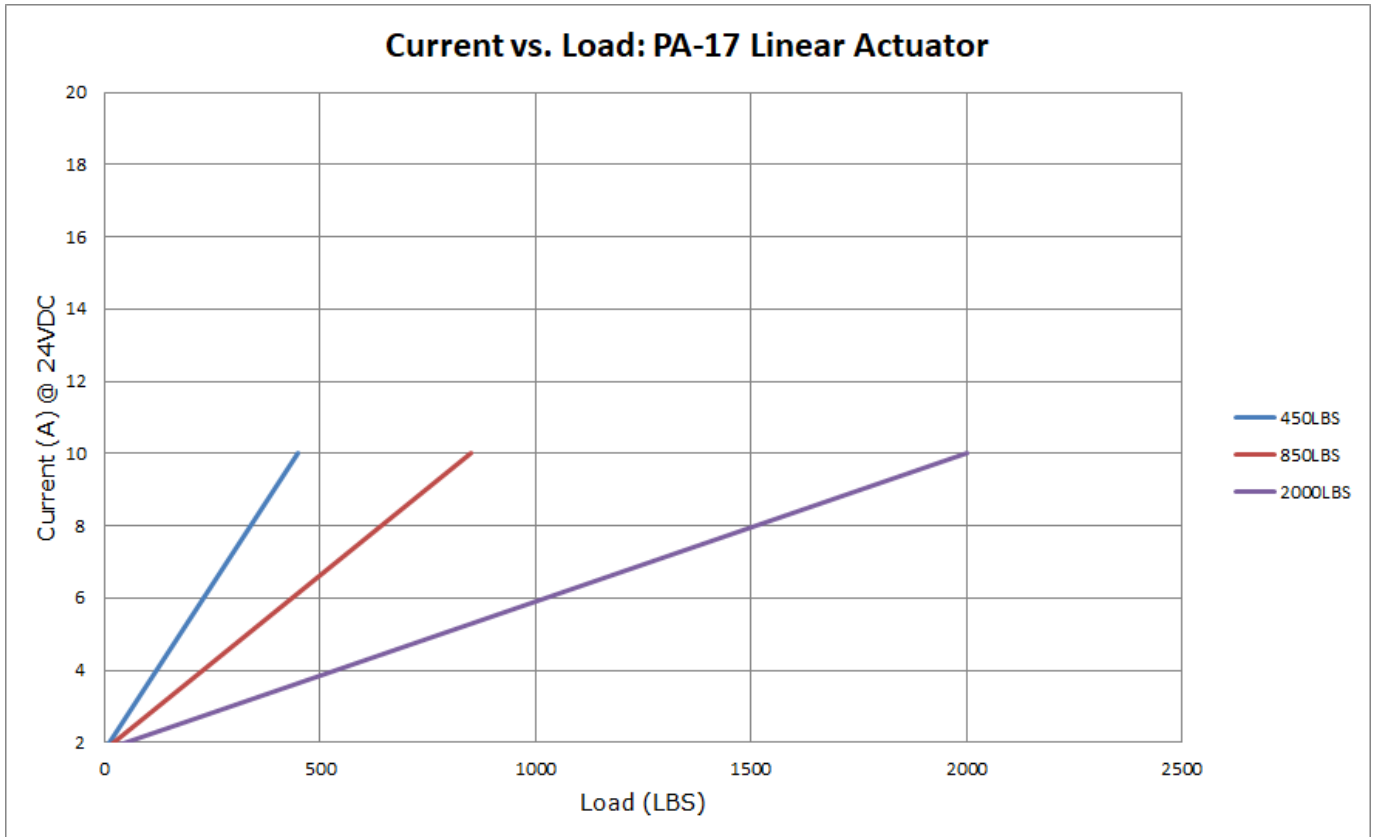



Standard Specifications

Front View

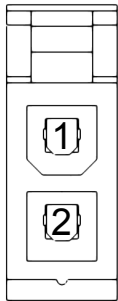

2-Pin Mini-Fit Jr
Molex Connector

Motor	
1	2
M-	M+

Components	Part Name	Part Number	Mating Part Number
Housing	Molex Mini Fit Jr 2-Pin Receptacle	39-01-2020	39-01-2023

Hall Effect Specifications

Front View

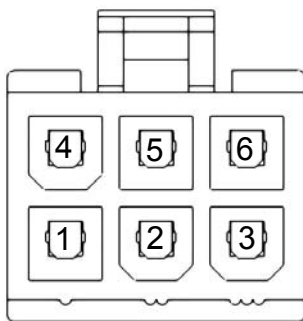

6-Pin Mini-Fit Jr
Hall Effect Connector

Motor		Hall Sensor			
4	5	2	3	1	6
M- (Retract)	M+ (Extend)	GND	+5VDC	Signal 2 Leads when Extending	Signal 1 Leads when Retracting

Component	Part Name	Part Number	Mating Part Number
Housing	Molex Mini Fit Jr 6-Pin Receptacle	39-01-2060	39-01-2061

Output Signal Extending		Output Signal Retracting	
Hall Effect 1 Signal		Hall Effect 1 Signal	
Hall Effect 2 Signal		Hall Effect 2 Signal	

Force	Resolution (Pulses/inch)
450	51
850	101
1600	203
2000	203



Connectors & Feedback

Potentiometer Specifications

Max stroke length for POT is 24". The PA-17 POT will come with tinned wire leads without connectors.

Motor		Potentiometer		
Red	Black	Red/Blue	Yellow	White
M+ (Extend)	M- (Retract)	Wiper	10K ohm	0K ohm
15 AWG	15 AWG	22 AWG	22 AWG	22 AWG

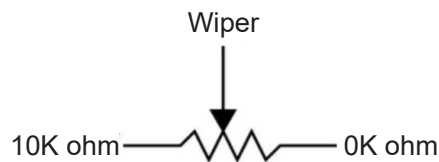

Resistance*	Number of Turns	Tolerance
0-10kΩ	10	+/- 5%

*Actual resistance value may vary within the 0-10kΩ range based on stroke length

Internal Components



Non-standard features are not shown in the image below.

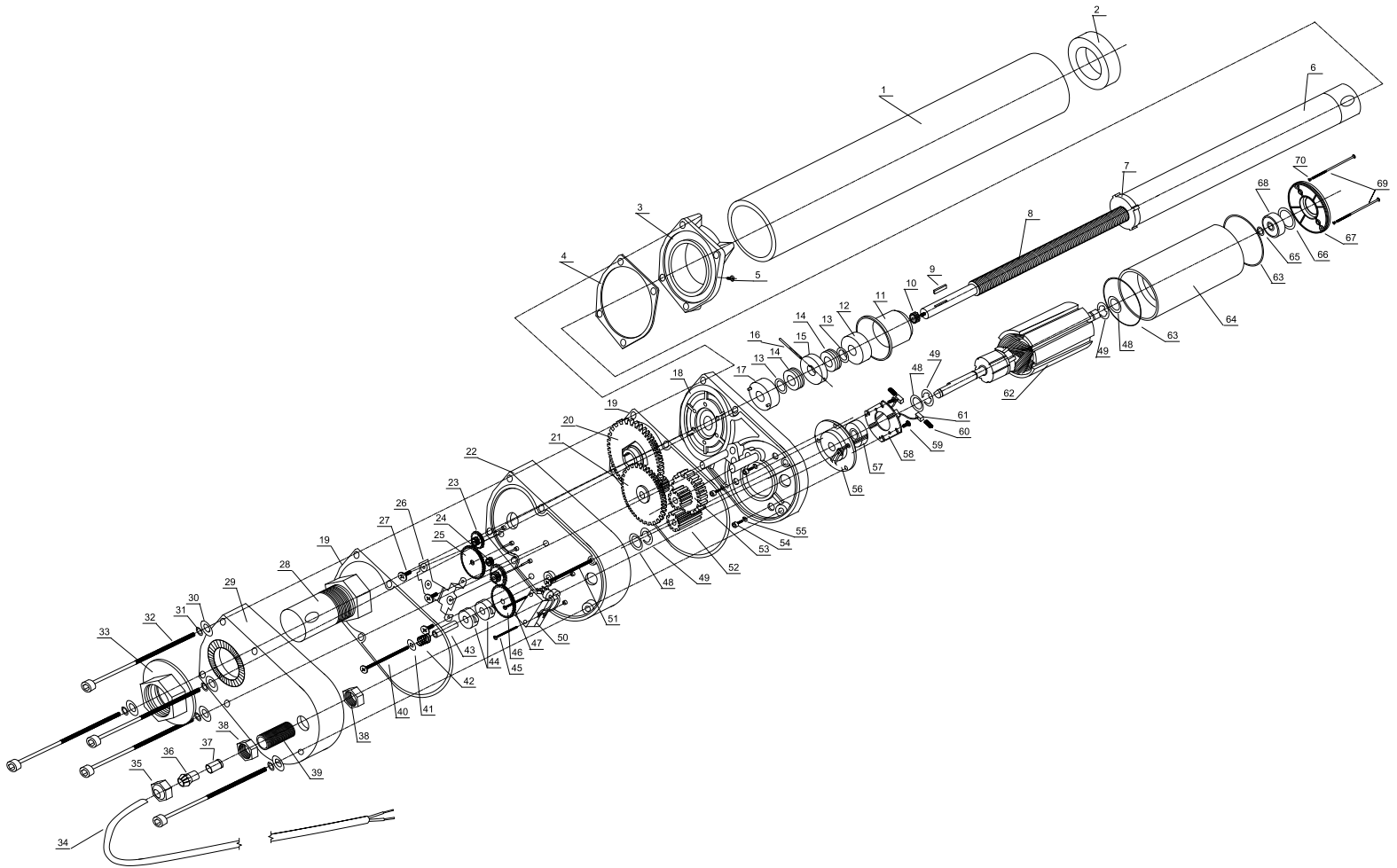

Internal Descriptions



Non-standard features are not shown in the table below.

Item	Description	Qty
1	Actuator Case	1
2	Case Top Cap	1
3	Case Base Support	1
4	Case Base Gasket	1
5	Case Base Screw	1
6	Shaft With Mounting Hole	1
7	Shaft Guide	1
8	Treaded Shaft Drive	1
9	Shaft Gear Lock	1
10	Limit Switch Gear	1
11	Shaft Bearing Enclosure	1
12	Shaft Top Bearing Holder	1
13	Washer	2
14	Shaft Ball Bearing	2
15	Shaft Holder	1
16	Shaft Holder Lock	1
17	Shaft Bearing Bottom Support	1
18	Actuator Base	1
19	Actuator Base Gasket	2
20	Shaft Gear Wheel	1
21	Intermediate Gear	1
22	Limit Switch Base	1
23	Limit Switch Gear 1	1
24	Limit Switch Gear 2	1
25	Limit Switch Gear 3	1
26	Limit Switch Gear Support	1
27	Limit Switch Gear Support Screw	3
28	Actuator Bottom Mount	1
29	Actuator Bottom Case	1
30	Actuator Base Screw Gasket	5
31	Actuator Base Screw O-Ring	5
32	Actuator Base Screw	5
33	Actuator Bottom Mount Nut	1
34	Power Cable	1
35	Power Cable Lock Screw	1

Item	Description	Qty
36	Power Cable Lock	1
37	Power Cable Sleeve	1
38	Power Cable Nut	2
39	Base Cable Sleeve	1
40	Limit Switch Trigger Screw	1
41	Limit Switch Trigger Washer	1
42	Limit Switch Trigger Spring	1
43	Limit Switch Trigger Support	1
44	Limit Switch Trigger	2
45	Limit Switch Screw	2
46	Limit Switch Gear 5	1
47	Limit Switch Gear 4	1
48	Motor Washer	3
49	Motor Locking Washer	3
50	Limit Switch	2
51	Base Holding Screw	1
52	Motor Gear	1
53	Motor Intermediate Gear	1
54	Motor Base Screw	3
55	Motor Base Screw Washer	3
56	Motor Bottom Cap	1
57	Motor Bottom Bearing	1
58	Brush Holder PCB	1
59	Brush Holder PCB Screw	2
60	Motor Brush Spring	2
61	Motor Brush	2
62	Electric Motor Rotor	1
63	Motor Case O-Ring	2
64	Motor Case and Stator	1
65	Motor O-Ring	1
66	Motor Top Spring Washer	1
67	Motor top Cap	1
68	Motor Top Bearing	1
69	Motor Case Screw	2
70	Motor Case Screw Washer	2