

# 100 Ton Heavyweight Jack

## MODEL ESJ-100-27

PROFESSIONAL  
SERIES

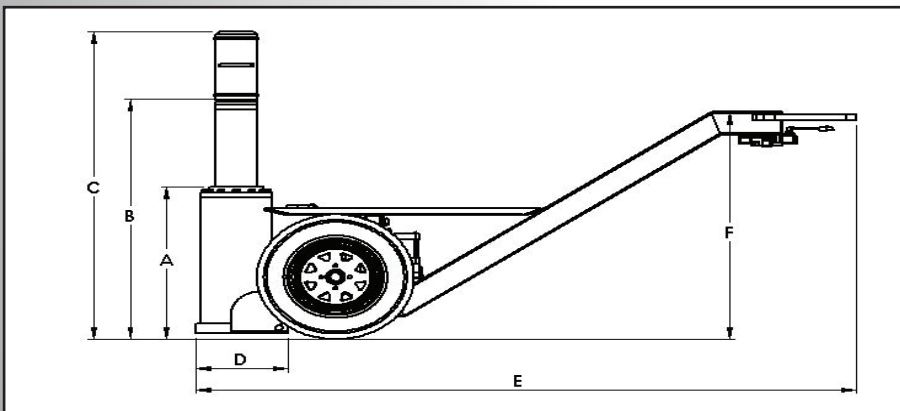
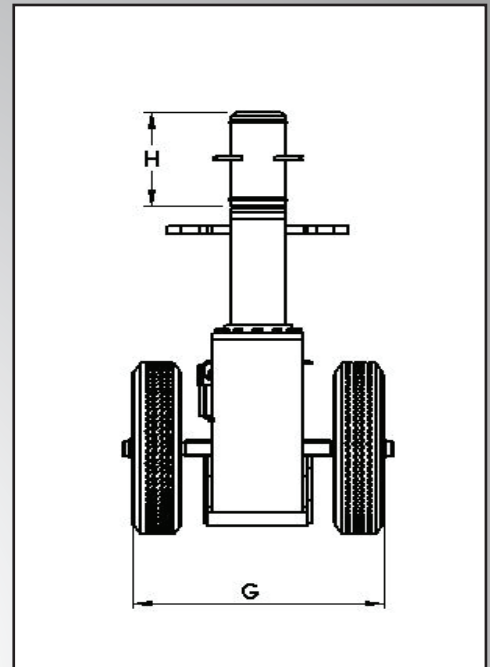

Capacity		100 Ton
Min. Height:	<b>A</b>	27" 69cm
Max. Height:	<b>B</b>	42" 107cm
Cylinder Base:	<b>D</b>	15" 38cm
Frame Length:	<b>E</b>	96" 244cm
Handle Height:	<b>F</b>	40" 102cm
Frame Width:	<b>G</b>	29" 74cm

Extension Height	Min. Height with Extension	Max. Height with Extension
(H)	(A+H)	(B + H = C)
6" 15cm	*33" 84cm	*48" 122cm
8" 20cm	*35" 89cm	*50" 127cm
10" 25cm	*37" 94cm	*52" 132cm
12" 30cm	*39" 99cm	*54" 137cm

\*Extensions can be custom manufactured to any height

NOTE: ESCO reserves the right to change, alter, or modify product(s) without notice. This includes but is not limited to product: color, design, parts, accessories, etc.

sales@esco.net WWW.ESCO.NET 1.800.352.9852



COPYRIGHT 2017 • 15270 Flight Path Drive • Brooksville, FL 34604

