

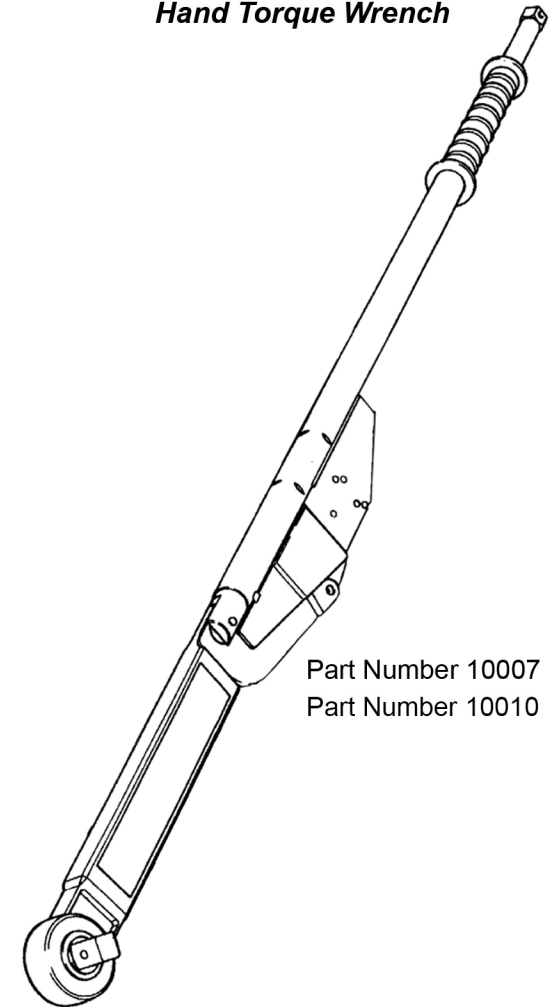

Break-Back Style

Hand Torque Wrench

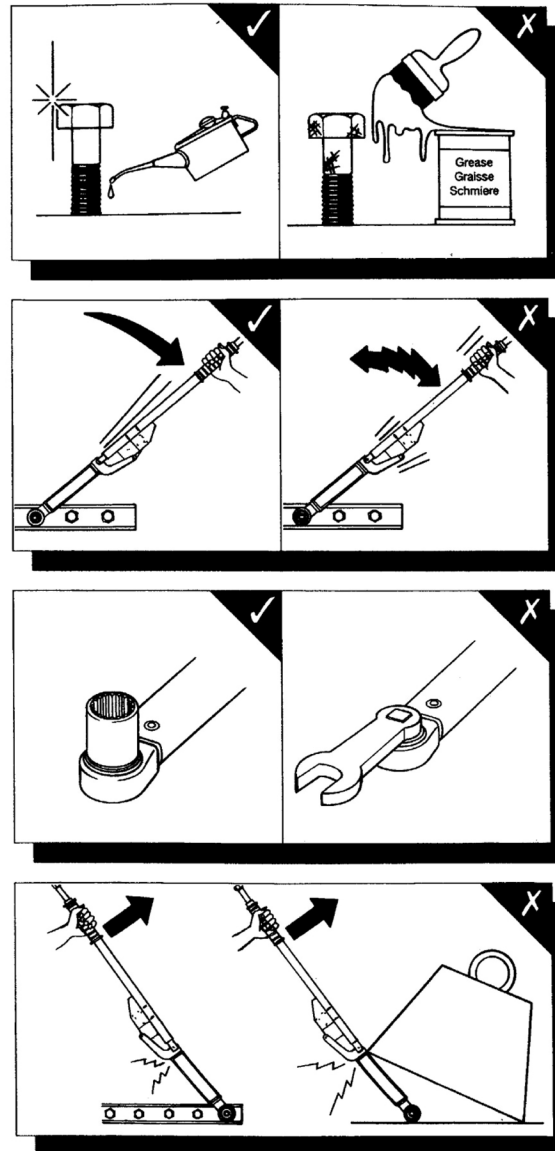
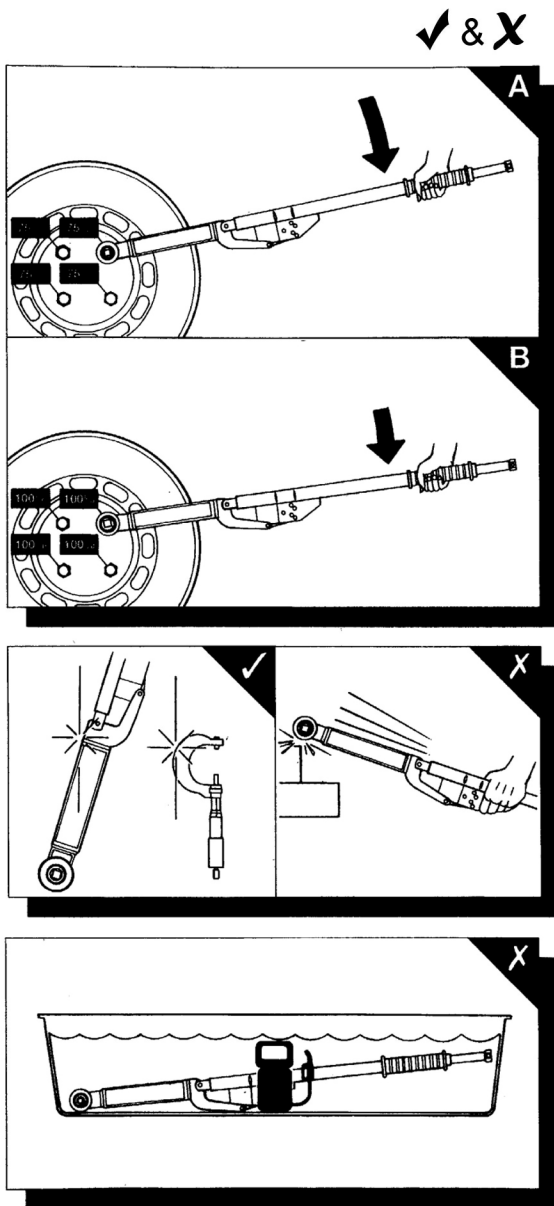

Part Number 10007
Part Number 10010

✓ = Yes X = No

✓ = Yes X = No

Equipment Supply Company

15270 Flight Path Drive

Brooksville, FL 34604

352-754-1117 • Fax 352-754-4508

www.esco.net • sales@esco.net

✓ = Yes X = No

- Align required torque with the end of the body tube
- Alignez l'échelle de lecture avec l'extrémité du tube du corps pour le couple désiré
- Einstellen und Ablesen des Skalenwertes am Rohrkörperende
- Allineare la copia necessaria con l'estremità del tubo
- Allinee el par de apriete requerido con el extremo del tubo del cuerpo

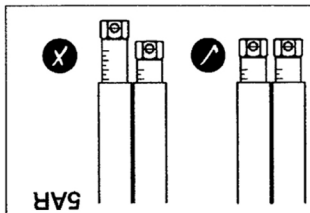
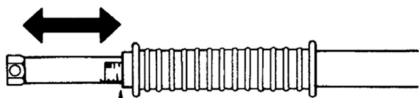

- Turn nut to adjust
- Tournez l'écrou pour effectuer le réglage
- Schlüssel durch Drehen der Skalenspindel einstellen
- Girare il dado per effettuare la regolazione
- Girar la tuerca para ajustar

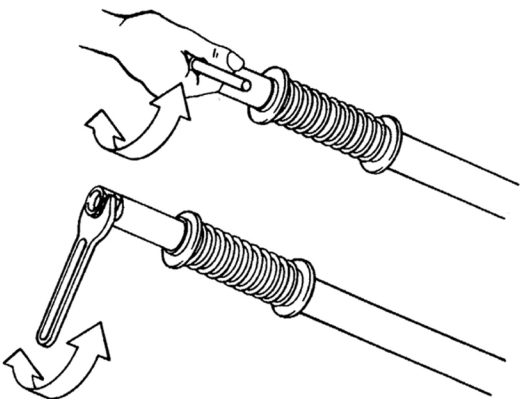

✓ = Yes X = No

- Push from the centre of handle
- Appuyez au centre de la poignée
- Betätigung nur von der Handgriffmitte
- Spingere dal centro della maniglia
- Accionar desde el centro del mango

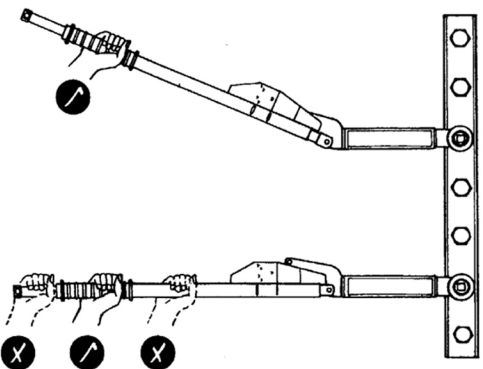

- Do not remove adjusting nut, calibration will be lost
- Ne pas retirer l'écrou de réglage. Sinon l'étalonnage sera perdu
- Skalenspindel nicht entfernen, da sonst die Kalibrierung ungenau wird
- Non levare il dado di regolazione, la taratura verrà persa
- No retire la tuerca de ajuste, se perderá la calibración

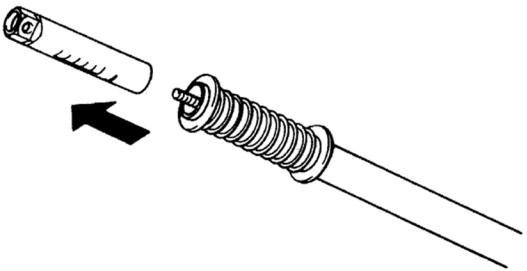

- Lubrication points
- Points de graissage
- Schmierstellen
- Punti di lubrificazione
- Puntos de lubricación

