

SUMMIT

BUILT-IN REFRIGERATOR

Model AL55

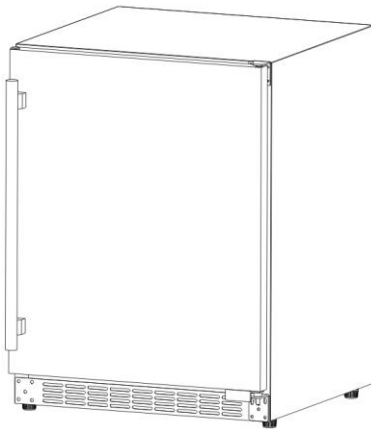

BEVERAGE COOLER

Model ALBV2466

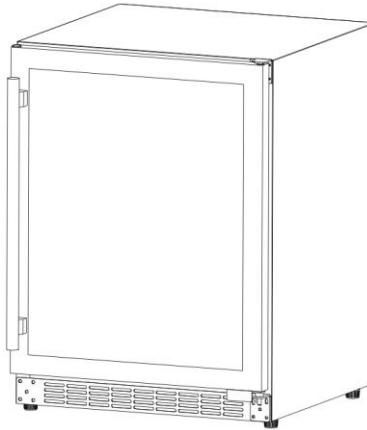

BEVERAGE COOLER

Model SCR2466B

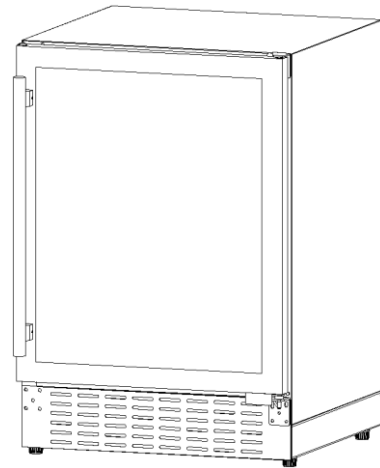

Owner's Manual

**BEFORE USE, PLEASE READ AND FOLLOW
ALL SAFETY RULES AND OPERATING INSTRUCTIONS**

Write Serial Number here:

Felix Storch, Inc.
An ISO 9001:2015 registered company
Summit Appliance Division
770 Garrison Avenue
Bronx, NY 10474
www.summitappliance.com

TABLE OF CONTENTS

Important Safety Instructions	3 – 4
Installation Instructions	5 – 6
Before using your appliance	5
Installation of your appliance	5
Reversing the door swing	6
Operation	7 – 8
Recommended temperatures for chilling wine	7
The controls of your appliance	7 – 9
Care and Maintenance	10
Cleaning your appliance	
Defrosting	
Power failure	
Vacations	
Transporting your appliance	
Energy-saving tip	
Problems with Your Appliance	11
Limited Warranty	12

IMPORTANT SAFETY INSTRUCTIONS

⚡WARNING⚡ To reduce the risk of fire, electrical shock or injury when using your appliance, follow these basic precautions

Read all instructions before using the appliance.

Plug into a grounded 3-prong outlet. Do not remove grounding prong, do not use an adapter, and do not use an extension cord.

It is recommended that a separate circuit, serving only your appliance, be provided. Use receptacles that cannot be turned off by a switch or pull chain.

Never clean appliance parts with flammable fluids. These fumes can create a fire hazard or explosion.

Before proceeding with cleaning and maintenance operations, make sure the power line of the unit is disconnected.

Do not connect or disconnect the electric plug when your hands are wet.

Unplug the appliance or disconnect the power before cleaning or servicing. Failure to do so can result in electrical shock or death.

Do not attempt to repair or replace any part of your appliance unless it is specifically recommended in this manual. All other servicing should be referred to a qualified technician.

Do not store or use gasoline or any other flammable vapors and liquids in the vicinity of this or any other appliance. The fumes can create a fire hazard or explosion.

Use two or more people to move/install the appliance. Failure to do so can result in back or other injury.

To ensure proper ventilation for your appliance, the front of the unit must be completely unobstructed. Choose a well-ventilated area with temperatures above 61°F (16°C) and below 95°F (35°C). This unit must be installed in an area protected from the elements, such as wind, rain, water spray or drips.

The appliance should not be located next to ovens, grills or other sources of high heat.

The appliance must be installed with all electrical connections in accordance with state and local codes. A standard electrical supply (115V AC only, 60 Hz), properly grounded in accordance with the National Electrical Code and local codes and ordinances, is required.

Do not kink or pinch the power supply cord of the appliance.

The fuse (or circuit breaker) size should be 15 amps.

It is important for the appliance to be leveled in order to work properly. You may need to make several adjustments to level it.

Although the unit has been tested at the factory, due to transit and storage, you should clean the appliance before use.

Do not use solvent-based cleaning agents or abrasives on the interior. These cleaners may damage or discolor the interior.

Do not use this apparatus for other than residential purposes.

This appliance is CFC- and HFC-free and contains small quantities of Isobutane (R600a) which is environmentally friendly, but flammable. It does not damage the ozone layer, nor does it increase the greenhouse effect. Care must be taken during transportation and setting up of the appliance that no parts of the cooling system are damaged. Leaking coolant can ignite and may damage the eyes.

In the event of any damage:

- Avoid open flames and anything that creates a spark,
- Disconnect from the electrical power line,
- Air the room in which the appliance is located for several minutes, and
- Contact the Service Department for advice.

The more coolant there is in an appliance, the larger the room it should be installed in. In the event of a leakage, if the appliance is in a small room, there is the danger of combustible gases building up. For every ounce of coolant, at least 325 cubic feet of room space is required. The amount of coolant in the appliance is stated on the data plate on the back of the appliance. It is hazardous for anyone other than an authorized Service Person to carry out servicing or repairs to this appliance.

Take serious care when handling, moving, and using the appliance to avoid either damaging the refrigerant tubing or increasing the risk of a leak.

Replacing component parts and servicing shall be done by factory authorized service personnel so as to minimize the risk of possible ignition due to incorrect parts or improper service.

DANGER! *Risk of child entrapment*

Child entrapment and suffocation are not problems of the past. Junked or abandoned appliances are still dangerous, even if they will “just sit in the garage a few days”.

Before you throw away your old wine cooler or any appliance: Remove the door. Leave the shelves in place so that children may not easily climb inside.

Never allow children to operate, play with, or crawl inside the appliance.

- SAVE THESE INSTRUCTIONS -

INSTALLATION INSTRUCTIONS

Before Using Your Appliance

Remove the exterior and interior packing.

Before connecting the appliance to the power source, let it stand upright for approximately 2 hours. This will reduce the possibility of a malfunction in the cooling system from handling during transportation.

Clean the interior surface with lukewarm water using a soft cloth.

Install the handle.

Installation of Your Appliance

This appliance is designed for free standing or built-in (fully recessed) installation. If free standing, the unit should have at least 4" of clearance at both sides, at the top and at the back to allow for adequate ventilation. If it is built-in, leave 3/16" at both sides, 1/16" at the top and 2" at the rear. Be sure that airflow under the appliance is not blocked.

Place your appliance on a floor that is strong enough to support it when it is fully loaded. To level your appliance, adjust the front leveling legs at the bottom.

Locate the appliance away from direct sunlight and sources of heat (stove, heater, radiator, etc.). Direct sunlight may affect the acrylic coating and heat sources may increase electrical consumption. Extremely cold ambient temperatures may also cause the unit not to perform properly.

Avoid locating the unit in moist areas.

Plug the appliance into an exclusive, properly installed and grounded wall outlet. Do not under any circumstances cut or remove the third (ground) prong from the power cord. Any questions concerning power and/or grounding should be directed toward a certified and authorized products service center.

The handle is stored inside the unit. Install using the screws (supplied).

Reversing the Door Swing

This appliance has the capability of the door opening from either the left or right side. The unit is delivered to you with the door opening from the left side. Should you desire to reverse the opening direction, please follow the instructions below:

To make the reversal, you will find two hardware pieces in a plastic bag inside the appliance: the top left hinge and the bottom left hinge. The bottom support bracket is used for both sides.

1. Carefully lay the appliance on its back. Use cushioning to protect the floor and appliance.
2. Using a Phillips screwdriver, remove the two screws and bottom right hinge beneath the door. Keep the hinge in a safe place in case you need to reverse the door again in the future.
3. Carefully slide the door off and place it on a padded surface.
4. Interchange the plastic shaft sleeves at the top of the door.
5. Remove the bottom support bracket from the right side.
6. Remove the top right hinge and keep in a safe place in case you want to reverse the door in the future.
7. Remove the screws from the top left and transfer to the right.
8. Install the top left hinge.
9. Install the bottom left hinge to the door. Do not over-tighten the screw.
10. Place the door back on the appliance, lining up the top hinge.
11. Install the bottom support bracket.
12. Adjust door alignment. When set, tighten screw on hinge.
13. Remove handle. Transfer the screw hole covers to the left and install the handle on the right.

OPERATION

Recommended Temperatures for Chilling Wine

Red Wines:	15 - 18°C (59 - 64.4°F)
Dry / White Wines:	9 - 14°C (48.2 - 57.2°F)
Sparkling Wines:	5 - 8°C (41 - 46.4°F)

The cabinet temperature may vary slightly depending on whether or not the interior light is ON or OFF, and whether the bottles are located in the upper/middle or lower section of the cabinet.

The Controls of Your Appliance

The appliance should be placed where the ambient temperature is between 16-35°C (61 - 95°F). If the ambient temperature is above or below this range, the performance of the unit may be affected. For example, placing your unit in extremely cold or hot conditions may cause interior temperatures to fluctuate.

Control Panel



Setting the temperature Control

Model **AL55**:















Adjustable temperature: 2°C to 8°C (36°F to 46°F)

Models **ALBV2466, SCR2466B**:

Adjustable temperature: 1°C to 18°C (34°F to 65°F)

- Set the desired temperature by pressing the corresponding buttons, ▲ to increase or ▼ to decrease. Each press is a 1-degree increment or decrement. Once released, set temperature will flash for approximately 5 seconds, then revert back to display the internal temperature.
- To view your set temperature, press either the ▲ or ▼ button once and LED display will flash set temperature for 5 seconds.
- The appliance has the capability to display temperature in either Celsius or Fahrenheit. To change the temperature scale, press and hold both ▲▼ buttons simultaneously for approx. 3 seconds.

Note: The temperature inside may vary slightly depending on whether or not the interior bulb is ON or OFF and where the bottles are located.

ECO mode:	<p>Press and hold the button  for 3 seconds to enter or exit ECO mode.</p> <p>In this mode, the interior LED light, the compressor indicator  and the temperature value on the display panel will be turned off and the symbol ° will illuminate on the upper left corner of °C / °F.</p>
 Light / Lock	<p>LED lamp brightness mode: with Memory IC (when unit restarts after power failure unit, will auto recover to last setting), the default brightness is 100%. Each time the button  is pressed, the brightness of the LED will be cycled through the four positions (100%, 75%, 50%, OFF)</p> <p>Press and hold for 3 seconds to lock or unlock the control panel.</p>
 ON/OFF Power / Mute	<p>To turn the appliance on or off, press and hold the ON/OFF button for 3 seconds. When the high/low temperature alarm is activated, the buzzer will sound continuously. Press  one time to turn off the alarm.</p>
 LOCK	<p>If illuminated, indicates the control panel is locked.</p>
 RUN	<p>When unit's compressor is running, this indicator light will illuminate to signify that cooling mode is currently in operation.</p>
Demo mode	<p>Press and hold buttons ,  and  simultaneously for 10 seconds to enter or exit demo mode.</p> <p>In this mode, the display panel can operate settings, but the temperature is a fixed display 12°C (54°F) and all fans plus the compressor will not start.</p>
Sabbath mode	<p>Press and hold buttons  and  at the same time for at least 5 seconds to enter or exit Sabbath mode. In this mode, LED will display "Sb". This mode turns off the displays, interior light and prevents them from turning on again. Normal cooling operations will still take place. The compressor and the fan work normally.</p> <p>When the cabinet power off, it will not automatically exit Sabbath mode, and it will keep Sabbath mode when power on again. The Sabbath Mode will automatically turn off after 96 hours.</p>
Defrosting	<p>The unit defrosts automatically in normal operating conditions.</p> <p>The evaporator behind the rear wall of the unit defrosts automatically. Water will drain through the drain pipe from the back of the product. Users need to bring the water to the drain or find an appliance to load the water. (If loading with an appliance, you need to pay attention to clearing the water regularly)</p> <p>However, frost may accumulate on the evaporator if the unit is repeatedly opened in a high heat or high humidity location. If this frost pattern does not clear within 24 hours, your unit will require manual defrosting.</p>
Mandatory defrost mode:	<p>Press the  and  at one time for 10 seconds to enter the compulsory defrost mode.</p>

NOTE:

If the unit is unplugged or turned off, or if there has been a power failure, you must wait 5 minutes before restarting the unit. If you attempt to restart before this time delay, the appliance will not start. When you use the appliance for the first time, or restart it after it has been shut off for a long time, there could be a few degrees variance between the temperature you select and the one indicated on the display. This is normal and due to the length of inactivation time. Once the appliance has been running for a few hours, everything will be back to normal.

Temperature Alarm Function

If the ambient temperature is $\geq 30^{\circ}\text{C}$ (86°F) for 2 hours, the high temperature alarm will be activated, the LED will display "HH", the buzzer will sound continuously, the cooling system continues to work. The display returns to normal when the high temperature condition is relieved.

If the ambient temperature is $< 0^{\circ}\text{C}$ (32°F) for 1 hour, the low temperature alarm will be activated, the LED will display "LL", the buzzer will sound continuously, the cooling system will stop working. The display returns to normal when the low temperature is relieved.

NOTE:

It is normal that the cabinet shows "HH" or "LL" from time to time. If it occurs frequently or lasts for a long time, you can restart the unit by unplugging it, then re-plugging after 5 minutes. If the problem occurs again after restarting, please contact customer service.

Before reconnecting the power, wait 3 to 5 minutes. Otherwise you could damage your appliance. If you attempt to start the appliance before the end of this time delay, the appliance will not turn on.

If you turn on the appliance for the first time or after a restart, or after it has been out of operation for a long time, there may be a temperature difference between the temperature inside the appliance and that on the LED display. This is a normal event caused by the duration of the activation period. Leave the appliance turned on for several hours and the temperature will stabilize during operation.

CALIFORNIA CARB/SNAP DISCLOSURE

This product uses eco-friendly hydrocarbon refrigerant and fully complies with California CARB regulations.

However, we are required by California Law to provide the following disclosure statement in every product sold in California.

"This equipment is prohibited from use in California with any refrigerants on the 'List of Prohibited Substances' for that specific end-use, in accordance with California Code of Regulations, title 17, section 95374. This disclosure statement has been reviewed and approved by Felix Storch, Inc. and Felix Storch, Inc. attests, under penalty of perjury, that these statements are true and accurate."

This product does **not** use any refrigerants on the 'List of Prohibited Substances'"

CARE AND MAINTENANCE

Cleaning Your Appliance

1. Turn off the power, unplug the appliance, and remove all items including shelves and racks.
2. Wash the inside surfaces with a warm water and baking soda solution. The solution should consist of about 2 tablespoons of baking soda to a quart of water.
3. Wash the shelves with a mild detergent solution.
4. Wring excess water out of the sponge or cloth when cleaning the area of the controls or any electrical parts.
5. Wash the exterior of the cooler with a warm solution of mild liquid detergent. Rinse well and wipe dry with a clean soft cloth.
6. For stainless steel surfaces, routine cleaning can be accomplished by using warm water and a cloth. Dry with a towel or cloth to prevent water spots. Wipe in the directions of the brush lines. For cleaning that needs more power, you can use a mild detergent in warm water. Make sure to rinse the surface thoroughly to prevent staining and spotting. Towel dry.

Defrosting

Defrosting of the inside of the appliance occurs automatically during operation. Approximately every 8 hours, the compressor will stop running for about 30 minutes. During defrosting the temperature will be higher than you set. The defrost water is collected by the evaporating tray above the compressor and evaporates automatically.

Power Failure

Most power failures are corrected within a few hours and should not affect the temperature of your appliance if you minimize the number of times the door is opened. If your power is going to be off for a longer period of time, you need to take the proper steps to protect your contents.

Vacations

Leave the appliance operating during vacations of less than three weeks. If you turn off the appliance for extended periods, leave the door slightly ajar to prevent odor building up inside.

Transporting Your Appliance

If you need to move your appliance once the box has been discarded:

1. Securely tape down all loose items (shelves) inside your appliance.
2. Turn the adjustable legs up to the base to avoid damage.
3. Tape the door shut.
4. Be sure the appliance stays secure in the upright position during transportation. Also protect the outside of the appliance with a blanket or similar item.

Energy-Saving Tip

The appliance should be located in the coolest area of the room, away from heat-producing appliances and out of direct sunlight.

PROBLEMS WITH YOUR APPLIANCE

You can solve many common problems easily, saving you the cost of a possible service call. Try the suggestions below to see if you can solve the problem before calling for service.

TROUBLESHOOTING GUIDE

PROBLEM	POSSIBLE CAUSE	REMEDY
Appliance does not operate.	The unit defrosts automatically in normal operating conditions. The appliance is turned off. Tripped circuit breaker or a blown fuse.	Connect the appliance. Switch on the appliance. Switch on the circuit breaker or replace the fuse.
Appliance is not cold enough.	The temperature is not set correctly. The ambient temperature could require a lower temperature setting. The condenser is too dirty. The ventilation opening is blocked or too dusty.	Check the set temperature. Set a lower temperature. Clean the condenser when necessary. Clear the obstructions and wipe off the dust.
Appliance turns itself on and off frequently.	The room temperature is higher than average. A large number of bottles has been added to the unit.	Put the appliance in a cooler place. Leave the appliance to work for a while until the set temperature has been reached.
The light does not work.	Appliance is not connected to a power supply. Tripped circuit breaker or a blown fuse. The light was switched off on the control panel.	Connect the appliance. Switch on the circuit breaker or replace the fuse. Switch on the light.
Vibrations	The appliance is not properly level.	Level the appliance with the adjustable feet.
The appliance seems to make too much noise.	The rattling noise may come from the flow of the refrigerant, which is normal. As each cycle ends, you may hear gurgling sounds caused by the flow of refrigerant in your appliance. If temperature fluctuations occur, the contraction and expansion of the inner walls may cause popping and crackling noises.	
	The appliance is not properly level.	Level the appliance with the adjustable feet.
Display "E1", "E2".	"E1" or "E2" indicates that the air temperature sensor has failed.	Call for service.

LIMITED WARRANTY

ONE-YEAR LIMITED WARRANTY

Within the 48 contiguous United States, for one year from the date of purchase, when this appliance is operated and maintained according to instructions attached to or furnished with the product, warrantor will pay for factory-specified parts and repair labor to correct defects in materials or workmanship. Service must be provided by a designated service company. Outside the 48 states, all parts are warranted for one year from manufacturing defects. Plastic parts, shelves and cabinets are warranted to be manufactured to commercially acceptable standards, and are not covered from damage during handling or breakage.

5-YEAR COMPRESSOR WARRANTY

1. The compressor is covered for 5 years.
2. Replacement does not include labor.

ITEMS WARRANTOR WILL NOT PAY FOR:

1. Service calls to correct the installation of your appliance, to instruct you how to use your appliance, to replace or repair fuses or to correct wiring or plumbing.
2. Service calls to repair or replace appliance light bulbs or broken shelves. Consumable parts (such as filters) are excluded from warranty coverage.
3. Damage resulting from accident, alteration, misuse, abuse, fire, flood, acts of God, improper installation, installation not in accordance with electrical or plumbing codes, or use of products not approved by warrantor.
4. Replacement parts or repair labor costs for units operated outside the United States.
5. Repairs to parts or systems resulting from unauthorized modifications made to the appliance.
6. The removal and reinstallation of your appliance if it is installed in an inaccessible location or is not installed in accordance with published installation instructions.

DISCLAIMER OF IMPLIED WARRANTIES—LIMITATION OF REMEDIES

CUSTOMER'S SOLE AND EXCLUSIVE REMEDY UNDER THIS LIMITED WARRANTY SHALL BE PRODUCT REPAIR AS PROVIDED HEREIN. IMPLIED WARRANTIES, INCLUDING WARRANTIES OF MERCHANTABILITY OR FITNESS FOR A PARTICULAR PURPOSE, ARE LIMITED TO ONE YEAR. WARRANTOR SHALL NOT BE LIABLE FOR INCIDENTAL OR CONSEQUENTIAL DAMAGES. SOME STATES DO NOT ALLOW THE EXCLUSION OR LIMITATION OF INCIDENTAL OR CONSEQUENTIAL DAMAGES, OR LIMITATIONS ON THE DURATION OF IMPLIED WARRANTIES OF MERCHANTABILITY OR FITNESS, SO THESE EXCLUSIONS OR LIMITATIONS MAY NOT APPLY TO YOU. THIS WARRANTY GIVES YOU SPECIFIC LEGAL RIGHTS AND YOU MAY ALSO HAVE OTHER RIGHTS, WHICH VARY FROM STATE TO STATE.

WARNING: This product can expose you to chemicals including Nickel



Metallic) which is known to the State of California to cause cancer.

For more information go to www.P65Warnings.ca.gov

FELIX STORCH, INC.

770 Garrison Avenue

Bronx, NY 10474

Phone: (718) 893-3900

For parts and accessory ordering,
troubleshooting and helpful hints, visit:

www.summitappliance.com/support

SUMMIT

Printed in China