

THOR

K I T C H E N[®]

INSTRUCTION MANUAL

TWC2403DI

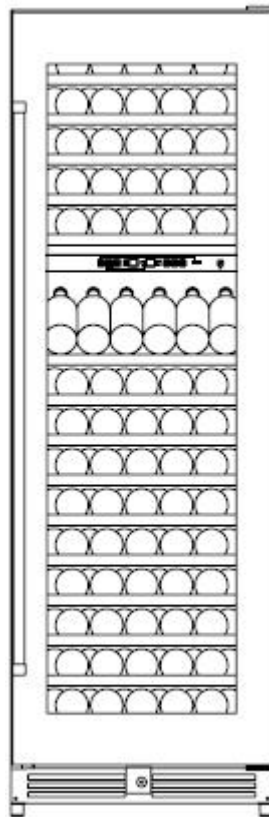

TABLE OF CONTENTS

Contents	Page#
● Wine Cooler Package Contents	3
● Important Safety Instructions	3
● Main structure of Product	4
● Installation	5-6
● Operating Instructions	7-10
● Points of intentions	10
● Product parameters	10
● Layout and storage	11
● Care and maintenance	11-12
● Troubleshooting guide	12-13
● Warranty	13

● Wine Cooler Package Contents

- Instruction Manual
- 1 Wine Cooler unit

● Important Safety Instructions

WARNING: To reduce the risk of fire, electric shock or personal injury, unplug or disconnect the appliance from the power supply before servicing.

- Read all instructions before using the wine cooler.
- **DANGER:** Risk of child becoming trapped in new wine cooler, old wine cooler/refrigeration unit, or large boxes. Junked or abandoned appliances, boxes and other containers are still dangerous, even if they will just in the garage for a few days.
- Before you throw away your old wine cooler: 1. take off the door. 2. Leave the shelves in place so that children cannot climb inside.
- Never allow children to operate, play with, crawl inside the appliance.
- Never clean appliance parts with flammable fluids. The fumes can create a fire hazard or explosion.
- Do not store in the vicinity of any other appliance. Do not store near gasoline or any other flammable vapors. The fumes can create a fire hazard or explosion.

Before Using Your Wine Cooler

- Remove the exterior and interior packaging.
- Before connecting the wine cooler to power source, let it stand upright for approximately 2 hours. This will reduce the possibility of a malfunction in the cooling system from handling during transportation.
- Clean the interior surface with lukewarm water using a soft cloth.

Save These Instructions

- Check the Troubleshooting Guide at the back of this manual. List of will occur problems that you can fix it yourself.

● Main Structure Of Product

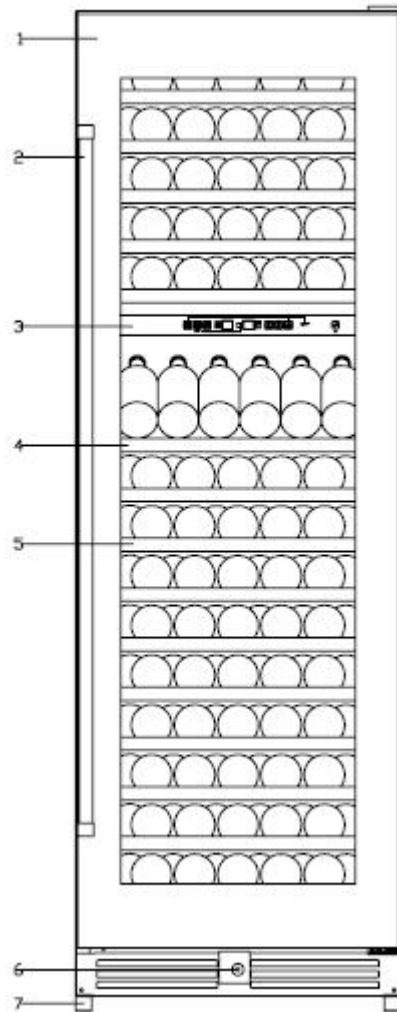

1. Stainless steel Door
2. Stainless Steel Handle
3. Display Control panel
4. Display shelf
5. Roll-Out Wood Shelves
6. Lock
7. Adjustable Feet

● Installation

Install handle

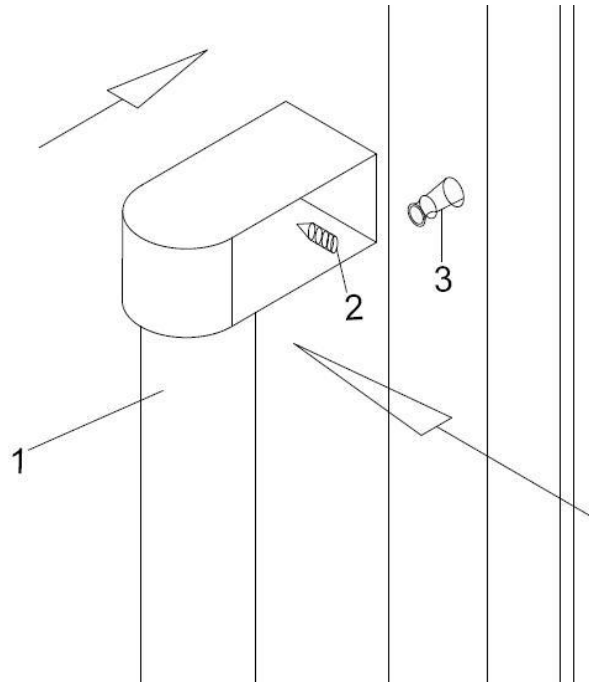

Locate the handle(1)over the pins(3)of the door and tighten the handle by screwing the Allen key grub screws(2)

CAUTION: do not over tighten the screws

Install the wine cooler:

Your product has been designed built-in or free standing installation.

Cutout Dimensions

Dimensions of the recess

Height of housing: 74Inch(1880mm)

Depth of housing: 27.6Inch(701mm)

Width of housing: 24.1Inch(612mm)

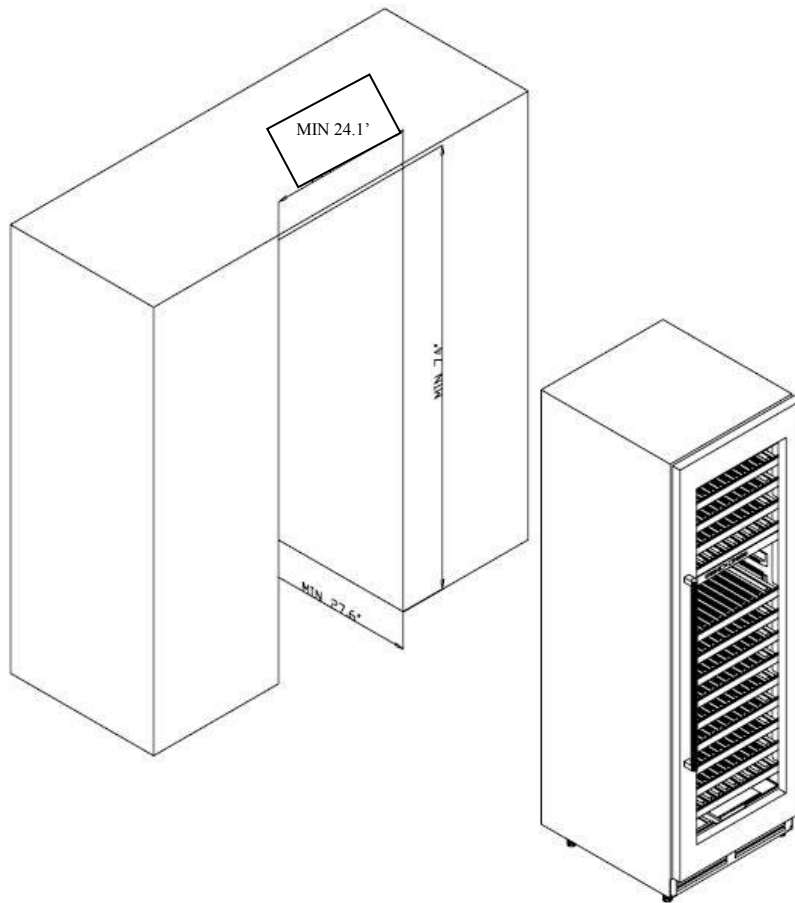

Attention: The ventilator should not be covered, or it will cause unpredictable breakdown; the fan and the return-airway should not be covered, too, or it will cause the temperature of the wine cooler couldn't reach the setting temperature, and the temperature of the cabinet is uneven.

● Operating Instructions

It is recommended that you installed your appliance **in a place where the ambient temperature is between 16-32°C (61°F-90°F)** . If the ambient temperature is above or below recommended temperatures, the performance of the unit may be affected and it may not be possible to obtain temperature between 5-12°C (41-54°F)/12-20°C (54-68°F).

Temperature setting

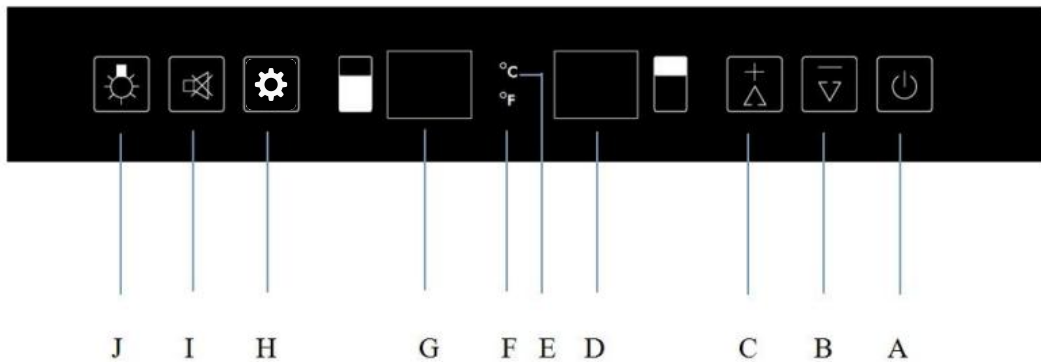



A	ON/OFF switch, turn on by pressing once, turn off by pressing and holding 5 seconds
B	Decrease temperature of 1 degree Celsius or Fahrenheit
C	Raise temperature of 1 degree Celsius or Fahrenheit
D	Display shows upper zone temperature at its setting. 5 seconds later, it will automatically turn to actual temperature inside the wine cellar till reaching setting one.
E	Temperature display in Celsius.
F	Temperature display in Fahrenheit.
G	Display shows lower zone temperature at its setting, 5 seconds later, it will automatically turn to actual temperature inside the wine cellar till reaching setting one.
H	Compartment selecting switch (lower or upper one). Once the compartment has been selected, it will show setting temperature as flash, 5 seconds later automatically turn to inner cabinet actual temperature till it reaches the setting one.
I	Alarm cancel switch, press once to cancel the alarm. Press and hold 5 seconds to change Celsius or Fahrenheit.
J	Light ON/OFF switch, turn on and turn off the light.

Temperature selection

The wine cooler has two temperature zones. The temperature setting of upper zone is adjustable with the range 5-12°C (41-54°F), which is ideal for storing sparkling and white wines. The temperature setting of lower zone is adjustable with the range 12-20°C (54-68°F), which is ideal for storing white and red wine.

NOTE: both two zones temperature could be set at 12°C (54°F) and it is workable as the time. But for optimal performance, once one zone is set at 12°C (54°F), we suggest another setting for the other zone with 3°C (37°F) difference at minimum (example : 5°C (41°F) upper and 8°C (46°F) lower). Maximum temperature difference between both compartments is 10°C (50°F). Always set cooler temperature in upper compartment and warmer temperature in the lower compartment (example: 5°C (41°F) upper and 15°C (59°F) lower).

- You can touch key “+” (C) and key “-” (B) to set the internal temperature for the selected zone. The degrees indicators will appear in the display window marked  for upper zone and  For lower zone.
- When the unit is plugged in for the first time. The LED readouts will show the original temperature set previously. Touch the “+”(C) and “-” (B) mark once of each compartment to set the desired temperature.
- The temperature will increase by 1°C or 1°F if you touch the “+”(C) mark once, or temperature will decrease by 1°C or 1°F if you touch the “-”(C) mark once.

Temperature display

To view the set temperature in either zone at any time, touch key H and the set temperature will temporarily flash on the display for 5 seconds. Then the display shows the current inner temperature again.

NOTE: when first used or after operating the wine cellar after a long period of inactivity, the inner temperature will not immediately be the temperature shows on the display. Indeed, it is necessary to wait a few hours for a temperature adjustment of the wine cellar in order to have a homogeneous temperature. To avoid excessive condensation when the ambient temperature is above 28°C (82°F), do not lower the temperature to below 7°C (45°F).

IMPORT: after unplugging, turning off the power or after a power failure, it is imperative to wait 5 minutes before turning it on again.

Temperature alarm

The alarm will sound and the temperature display will flash when:

- The temperature is on of the zones rises or falls outside the temperature range (5-12°C

(41-54°F) or 12-20°C (54-68°F))

- You switch the appliance on, if the temperature inside the appliance is very different (+/- 4°C) from the temperature set after hours working
- Too many items have been put into the unit at one time, and the temperature inside the appliance is very different (+/-4°C (39°F)) from the temperature set after 7 hours working.
- The door has not been closed tightly.

Door alarm

If the door has been left open for more than 60s, the alarm will sound. Once set temperature has been reach in the appliance, the alarm stops and the relevant temperature display stops flashing.

However, if the noise disturbs you, you can switch the alarm off before this if you wish by pressing the key “I” once, The alarm will stop. The relevant temperature display continues to flash until the set temperature has been reached. The display then lights up constantly and the alarm system is fully active again.

Interior light

The interior light makes it easy to view your wines labels and enhances the display of your collection. Touching the  mark (J) toggles between modes of operation for interior lights:

- Functional mode (default): the lights will turn on only when door is open, this is the most economic mode
- Showcase mode: the lights will be on whether or not the door is open. To turn this permanent light mode and get back the default mode, please push again the light button (J) 
- The interior light can be changed the color by manual switch. The light switch positions are like below picture (under the control panel) showed to control the color turn on/off.

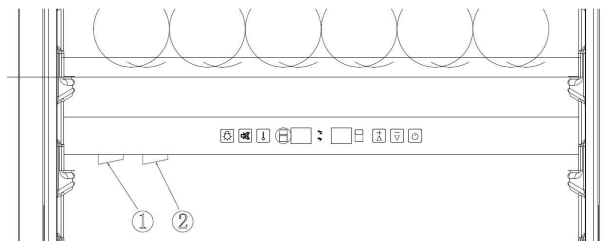

- ① Original color; ②Blue color

When turn on the original and blue color switch at the same time, the color vary by optical action.

Dynamic climate / silent mode

Wine cellars are designed to preserve your wines in perfect conditions over long periods in complete safety. However, no frost systems can cause noise, this is the reason why the

silent mode is the default factory setting, Thus, your can switch off the silent mode to switch to the ventilated cooling mode by pressing the key “+” (C) for 5 seconds. The cellar will emit 5 sound signals to confirm the passage in ventilated cooling mode. Conversely, to deactivate the ventilated cooling mode and return to the default silent mode, press and hold the key ”-” (B) for 5 seconds. The cabinet will emit 3 sound signals to confirm the silent mode.

Modes

SABBATH MODE

Sabbath mode is available for observance of certain religious holidays. This mode turns off the displays, interior light and audible alarms and prevent them from turning on again. Normal cooling operations will still take place. To initiate Sabbath mode, press the power (A) and light (J) keys at the same time for at least 5 seconds. The indicator light will flash four times and confirm the Sabbath mode is ON. Sabbath mode can be stopped by repeating the above process. The Sabbath mode will automatically exit after 96 hours.

ECO DEMO MODE

Eco demo mode can be activated by presenting the appliance at exhibitions, shows or in salesrooms. In eco demo mode, compressor and all fan motors are switch OFF. By pressing and holding the “+” and “-” (C and B) and light (J) keys at the same time for at least 5 seconds. The indicator light will flash five times to confirm the input and the unit will operate in eco demo mode. Eco demo mode can be abandoned by repeating the above process, be noted that compressor and fan will activate 5 minutes later (for compressor protection reason).

●Points Of Intentions

- 1, The vent grill outside the cabinet is the heat dissipation way of cooling system in wine cooler, please prevent anything from covering or blocking, or it will make the wine cooler overheating and cause accidents;
- 2, Please prevent the cooling and cold air circulating windows blocking, or it will make the temperature too high or uneven in the cabinet;
- 3, Please close the door tightly, it will cause the refrigerating efficiency down, overflow in the cabinet, or unnormal temperature once the door is not closed tightly for a long time.
- 4, Please shut off the power, and open the door to let the cabinet dry enough if you don't use the wine cooler for a long time.

●Product Parameters

- 1, Voltage: according to local voltage
- 2, Rated power: 370W
- 3, Climate type: ST

4, Temperature range in cabinet: 5-12°C (41-54°F) for upper zone, 12-20°C (54-68°F) for lower zone.

●Layout And Storage

Your cabinet was designed to store a maximum number of bottles securely. We recommend that you observe the below tips to optimize loading.

- Remove tape from shelves once unit is stable and ready for storage.
- Disperse the bottles evenly to avoid concentrating weight in one place. Bottles must not touch either the back of the cabinet.
- Make sure that the bottles are not all grouped together either at the top or bottom of the cabinet.
- Only pull out one shelf at a time. Never attempt to pull more than one.
- Maximum weight capacity per shelf is 55lbs
- You can crease your wine cooler storage capacity by removing shelves and stacking bottles on top of one another. Do not stack more than 3 rows of bottles per shelf.

●Care Maintenance

Cleaning your wine cooler

- Turn off the power, unplug the appliance, and remove all items including shelves and rack.
- Wash the inside surfaces with a warm water and baking soda solution. The solution should be about 2 tablespoons of baking soda to a pint of water.
- Wash the shelves with a mild detergent solution.
- Wring excess water out of the sponge or cloth when cleaning any area of the controls.
-
- Wash the outside cabinet with warm water and mild liquid detergent. Rinse well and wipe dry with a clean soft cloth.

Power Failure

- Most power failures are corrected within a few hours should not affect the temperature of your appliance if you minimize the number of times the door is opened. If the power is going to be off for a longer period of time, you need to take to take other measures to protect your contents.
- If the unit is unplugged, loses power, or is turned off you must wait 3 to 5 minutes before restarting. Attempting to restart the wine cooler before this time has elapsed may prevent the wine cooler from starting..

Vacation Time

- Short holidays: You may leave the Wine Cooler powered on and unattended for absences of less than three weeks.

- Long absences: If the appliance will not be used for several months, remove all items, turn off the appliance and unplug. Clean and dry the interior thoroughly. To prevent odour and mold growth, leave the door open slightly : blocking it open if necessary.

Moving Your Wine Cooler

- Remove all items.
- Securely tape down all loose items (shelves) inside your appliance.
- Turn the adjustable leg up to the base to avoid damage.
- Tape the door shut.
- Be sure the appliance stays secure in the upright position during transportation. Also protect outside of appliance with a blanket, or similar item.

Energy Saving Tips

- The Wine Cooler should be located in the coolest area of the room, away from heat producing appliances, and out of the direct sunlight.
- Ensure that the unit is adequately ventilated. Never cover air vents.
- Only open the door for as long as necessary.

● Troubleshooting Guide

Problems with Your Wine Cooler

Many common issues with your wine cooler can be solved very easily. Try the troubleshooting tips below should you experience any problems.

PROBLEM	POSSIBLE CAUSE
Wine Cooler does not operate.	Not plugged in. The appliance is turned off. The circuit breaker tripped or a blown fuse.
Wine Cooler is not cold enough.	Check the temperature control setting. External environment may require a higher setting. The door is opened too often. The door is not closed completely. The door gasket does not seal properly
Turns on and off frequently	The room temperature is hotter than normal. A large amount of contents has been added to the Wine Cooler. The door is open too often The door is not closed completely. The temperature control is not set correctly. The door gasket does not seal properly.
The light does not work.	Not plugged in. The circuit breaker tripped or a blown fuse. The light switch is "OFF".

Vibrations	Check to assure that the Wine Cooler is level.
The door will not close properly.	The Wine Cooler is not level. The door was reversed and not properly installed. The gasket is dirty. The shelves are out of position.
The Wine Cooler seems to make too much noise	The rattling noise may come from the flow of the refrigerant, which is normal. As each cycle ends, you may hear gurgling sounds caused by the flow of refrigerant in your Wine Cooler. Contraction and expansion of the inside walls may cause popping and crackling noises. The Wine Cooler is not level.

●Warranty

This product has been manufactured by Thor Group, 13831 Oaks Ave, Chino, California 91710.

Thor Group disclaims all express warranties except for the following:

This warranty applies to products purchased and located in the United States. Products purchased or located outside this area are excluded.

The warranty does not apply to damage resulting from abuse, accident, natural disaster, loss of electrical power to the product for any reason, alteration, outdoor use, improper installation, and improper operation, repair or service of the product by anyone other than an authorized Thor Group, service agency or representative.

Warranties and Duration

Warranty:2 year warranty on parts

Implied warranties terminate upon expiration of the limited warranty. Some states do not allow limitations on how long implied warranty lasts, so the above limitation may not apply to your implied warranty.

Thor Group will pay for:

All repair labor and cost of replacement parts found to be defective due to material and workmanship. Service must be provided by a Thor Group Authorized Service Agency during normal working hours. For a Service Agency nearest you, please call 877-288-8099.

Thor Group will not pay for:

This limited warranty does not cover:

1. Service to instruct you on how to use your wine cooler to correct house wiring, replace or repair house fuses, service to correct the installation of your wine cooler.
2. Repairs when your wine cooler is used for other than normal, single-family household use or when it is used in a manner that is contrary to published user or operator instructions and/or installation instructions.
3. Cosmetic damage, including chips, dents, scratches or other damage to the finish of your wine cooler, unless such damage results from defects in materials or workmanship and is reported to Thor Group within 30 days from the date of purchase.
4. Costs associated with the removal from your home of your wine cooler for repairs. This wine cooler is designed to be repaired in the home and only in-home service is covered by this warranty.
5. Damage resulting from misuse, alteration, accident, abuse, fire, flood, acts of God, improper installation, installation not in accordance with electrical, or use of consumables or cleaning products not approved by Thor Group.
6. Service to repair or replace consumable parts. Consumable parts are not included in the warranty coverage.
7. The removal and reinstallation of your wine cooler if it is installed in an inaccessible location or is not installed in accordance with published installation instructions.
8. This warranty is void if the factory applied serial number has been altered or removed from your wine cooler.
9. Repairs to parts or systems resulting from unauthorized modifications made to the appliance.
10. Expenses for travel and transportation for product service if your wine cooler is located in a remote area where service by an authorized Thor Group servicer is not available.
- 11. In any circumstance, Thor does not pay for food loss claims on wine cooler products.**

The warranty applies to appliances purchased and used for personal, family or household purposes only. It does not cover appliances used for commercial applications.

Should the appliance be sold by the original purchaser during the warranty period, warranty shall extend to the new owner until the expiration date of the original purchaser warranty period.

Warranty and Product Registration

Thor Group is not responsible for incidental or consequential damages. Under no circumstances will Thor Kitchen's liability exceed the cost that you paid for the product. Some states do not allow the exclusion or limitation of incidental or consequential damages, so the above limitations or exclusion may not apply to you.

This warranty gives you specific legal rights, and you may also have other rights that vary from state to state. Whenever you call our customer service at 877-288-8099 (THORKITCHEN WINE COOLER) for technical information and parts sales in the United States or to request service for your appliance, please have your complete model number and serial number ready. The model and serial number can be found on the product data plate. Please enter the information requested in the spaces provided.

Model No._____ **Serial No.**_____

Date of Purchase_____ **Purchaser**_____

Dealer_____ **Suburb**_____

Town_____ **Country**_____

Note: You must provide proof of purchase and installation date for in-warranty service.