



User Guide





Quality, Design and Innovation



home.liebherr.com/fridge-manuals



LIEBHERR

Symbol	Explanation
	Read instructions Please read the information in these instructions carefully to understand all of the benefits of your new appliance.
	Check appliance Check all parts for transport damage. If you have any complaints, please contact your agent or customer service.
	Differences These instructions apply to a range of models, so there may be differences. Sections that apply to certain models only are indicated by an asterisk (*).
	Instructions and results Instructions are marked with a ▶. Results are marked with a ▷.
	Videos Videos about the appliances are available on the YouTube channel of Liebherr-Hausgeräte.

These operating instructions apply to:

SIFNhi | 51..

Note

If your appliance has an N in its appliance designation, it is a NoFrost appliance.

- Freezer compartment light
- Bright LED interior light
- Door ajar alarm
- Handle grips on all extra-large drawers for easy transport
- Integrated transport grips on appliance housing
- Transport castors at back
- Easy to clean
- Door hinges can be reversed
- Door-on-door system for easy kitchen cabinet installation
- Soft stop mechanisms
- This appliance has a SabbathMode function, so you can use it on religious holidays. Further information can be found on the Star-K website www.star-k.org.

1.2 Delivered contents

Check all parts for damage during transport. If you have any complaints, please contact the dealer or Customer Service (see 9.4 Customer service) .

Delivery contains the following parts:

- Integrated appliance
- Equipment (depending on your model)
- Installation parts (depending on your model)
- User Guide
- Installation Guide
- Warranty documents

1 The appliance at a glance

1.1 Additional benefits

- Natural coolant
- Energy-optimized refrigerant circuit
- Energy-efficient insulation
- Low energy consumption
- User-friendly electronic controls
- Active function indicators
- Temperature can be controlled in the appliance independent of ambient conditions according to its climate rating - Temperature can be displayed as °C or °F
- The appliance defrosts automatically - no need to spend time defrosting
- Safety glass storage shelves
- Large freezing capacity
- Freezer over-temperature alarm
- Quick-freeze feature for fresh food (SuperFrost)
- Frozen food temperature indicator
- Power outage /FrostControl display
- All freezer drawers suitable for quick-freeze

The appliance at a glance

1.3 Overview of the appliance and equipment

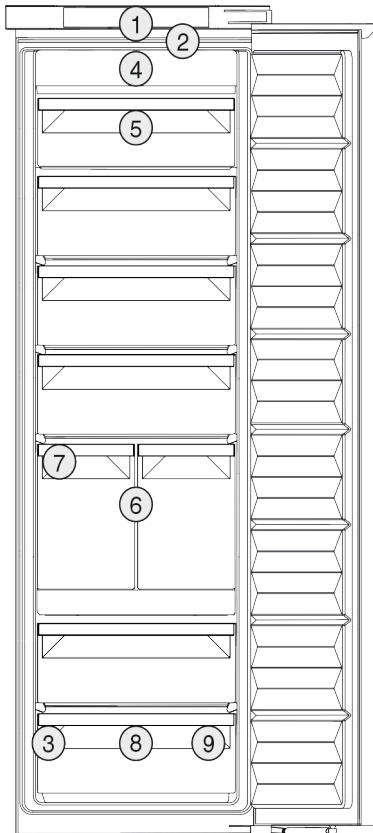

Fig. 1 Example illustration

Equipment

- (1) Controls
- (2) Lighting
- (3) Serial tag
- (4) NoFrost
- (5) Tilting drawer
- (6) IceTower
- (7) IceMaker
- (8) Freezer tray, cold storage accumulators
- (9) Ice cube scoop

Note

► The shelves, drawers, and baskets are arranged for optimal energy efficiency in the factory configuration. However, changes to the arrangement within the given insertion options – for example the arrangement of shelves in the fridge compartment – have no effect on energy consumption.

1.4 Range of appliance use

Normal use

This appliance is intended to be used in household and similar applications such as,

- staff kitchen areas in shops, offices and other working environments;
- farm houses and by clients in hotels, motels and other residential type environments;

- bed and breakfast type environments;
 - catering and similar non-retail applications.
- All other types of uses are not permitted.

Foreseeable misuse

The following uses are specifically prohibited:

- Storage and cooling of medication, blood plasma, laboratory preparations or similar substances and products in accordance with the CMDCAS and FDA 510(k)
- Use outdoors
- Use in moist areas exposed to the rain
- Use in outdoor areas with very high humidity
- Use in areas at risk of explosion

Incorrect appliance use can cause damage to the stored products or cause them to spoil.

Climate ratings

The appliance is set to operate within specific ambient temperature limits according to its climate rating. The climate rating for your appliance is printed on the rating plate.

Note

► To guarantee trouble-free operation, comply with the indicated ambient temperatures.

Climate rating	for ambient temperatures
SN, N	to 90 °F (32 °C)
ST	to 101 °F (38 °C)
T	to 110 °F (43 °C)

The appliance will function properly in ambient temperatures down to 41 °F (5 °C).

If your appliance has a fixed water connection, then the appliance is guaranteed to function correctly down to a lower ambient temperature of 32 °F (0 °C).

If your appliance does not have a fixed water connection, then the appliance is guaranteed to function correctly down to a lower ambient temperature of 5 °F (-15 °C).

1.5 Conformity

The refrigerant circuit has been tested for leaks. When installed, the appliance complies with the relevant safety regulations and the safety standards CAN/CSA-C22.2 No. 60335-1-11, 60335-2-24-06 and UL 60335-1, UL 60335-2-24.

2 General safety instructions

Please keep these operating instructions in a safe place so you can refer back to them at any time.

If you pass the appliance on, please hand these operating instructions to the new owner. Read and follow these instructions. They contain safety information which is important for safe and problem-free installation and operation. Always read and follow the safety information.

Dangers for the user:

- This appliance is not intended for use by persons (including children) with reduced physical, sensory or mental capabilities, or lack of experience and knowledge, unless they have been given supervision or instruction concerning use of the appliance by a person responsible for their safety. Children should be supervised to ensure that they do not play with the appliance. Cleaning and user maintenance must not be performed by children unless they are supervised. Children between the ages of 3 and 8 may load and unload the appliance. Children under the age of 3 must be kept away from the appliance unless they are constantly supervised.
- **IMPORTANT:** The power plug must be easily accessible so that the appliance can be disconnected from the mains quickly in an emergency. It must not be behind the back of the appliance.
- The socket must be easily accessible so that the appliance can be disconnected quickly from the electricity in an emergency. It must not be located in the area behind the appliance.
- Always hold the appliance at the plug when disconnecting it from the household power. Do not pull on the cable.
- Disconnect the power plug or fuse if there is a malfunction.
- Do not damage the power cable. Do not operate the appliance with a faulty power cable. If the supply cord is damaged, it must be replaced by the manufacturer, its service agent or similarly qualified persons in order to avoid a hazard. For Plug and Play connec-

tions, the change may be carried out by the customer.

- Repairs and work on the appliance may only be carried out by Customer Service or other specifically trained qualified personnel.
- Only install, connect and dispose of the appliance in accordance with the instructions.
- Only operate the appliance after it has been installed.
- The manufacturer is not liable for damage arising from a defective fixed water connection.*

Risk of fire:

- The refrigerant contained within the appliance (specifications on the identification plate) is environmentally friendly, but flammable. Leaking refrigerant can ignite.
 - **WARNING:** Do not damage the refrigerant circuit.
 - Do not handle ignition sources inside the appliance.
 - **WARNING:** Do not use electrical appliances inside the food storage compartments of the appliance, unless they are of the type recommended by the manufacturer (e.g. steam cleaning appliances, heating appliances, ice cream makers).
 - If refrigerant leaks: Remove naked flames or ignition sources located near the area of the leak. Ventilate the room well. Contact Customer Service.
- Do not operate the appliance near explosive gases.
- Do not store or use gasoline or other flammable gases and liquids near the appliance.
- Do not store explosive substances such as aerosol cans with a flammable propellant in this appliance. You can recognize such spray cans by the printed list of contents or by a flame symbol. Any leaking gases can be ignited by electrical components.
- Alcoholic beverages or other containers holding alcohol must always be tightly sealed for storage purposes. Any leaking alcohol can be ignited by electrical components.

Risk of falling or toppling over:

General safety instructions

- **WARNING:** To avoid a hazard due to instability of the appliance, it must be fixed in accordance with the instructions.
- Do not stand on the base, drawers, doors etc. or use them as improper supports. This applies in particular to children.

Danger of poisoning:

- Do not consume spoiled food.
- **WARNING:** Connect to potable water supply only.*
- Do not use any old or already premounted water supply lines.*

Danger of frostbite, feeling of numbness and pain:

- Avoid prolonged skin contact with cold surfaces or chilled/frozen food or take protective measures, e.g. wear gloves.

Risk of injury and damage:

- Hot steam may cause injuries. Do not use any electrical heating or steam cleaning equipment, naked flames or defrosting sprays for defrosting measures.
- **WARNING:** Do not use mechanical devices or other means to accelerate the defrosting process, other than those recommended by the manufacturer.
- Do not remove ice using sharp objects.
- **WARNING:** Keep clear of obstruction all ventilation openings in the appliance enclosure or in the structure for building-in.
- **WARNING:** Risk of child entrapment. Before you throw away your old refrigerator or freezer:
 - Take off the doors.
 - Leave the shelves in place so that children may not easily climb inside.

Risk of crushing:

- Do not hold onto the hinge when opening and closing the door. Fingers may become trapped.

California Proposition 65

- **WARNING:** This product can expose you to chemicals including Diisononyl Phthalate (DINP), which is known to the State of California to cause cancer, and Diisodecyl Phthalate (DIDP), which is known to the State of California to cause birth defects or other reproductive harm. For more information, go to www.P65Warnings.ca.gov

FCC Warning

- Changes or modifications not expressly approved by the party responsible for compliance could void the user's authority to operate the equipment.

FCC information

- This appliance has been tested and found to comply with the limits for a Class B digital device, pursuant to part 15 of the FCC Rules. These limits are designed to provide reasonable protection against harmful interference from an installation in residential areas. This appliance generates, uses and can radiate radio-frequency energy and, if not installed and used in accordance with the instructions, may cause harmful interference to radio communications. However, there is no guarantee that interference will not occur in a particular installation. If this appliance does cause harmful interference to radio or television reception, which can be determined by switching the appliance on and off, the user should try to correct the interference by one or more of the following measures:
 - Reorient or relocate the receiving antenna.
 - Increase the distance between the appliance and receiver.
 - Connect the appliance to an outlet on a circuit different from that to which the receiver is connected.
 - Consult the dealer or an experienced radio/TV technician for help.

FCC Radio Frequency Exposure Statement

- This appliance is found to comply with FCC radio frequency (RF) exposure limits set for an uncontrolled environment. This transmitter must not be set up or operated in conjunction with another antenna or another transmitter.
- This appliance should be installed and operated at a minimum separation distance of 20 cm between the antenna and your body. The user must follow the specific operating instructions to comply with the limits of RF exposure.

IC information

- This appliance has license-exempt transmitters/receivers, which comply with the license-exempt Radio Standards Specifica-

tion (RSS) of Innovation, Science and Economic Development Canada. Operation is subject to the following two conditions:

- This appliance may not cause interference.
- This device must accept any interference, including interference that may cause undesired operation of the device.

IC Radio Frequency Exposure Statement

- This appliance is found to comply with IC RSS-102 radio frequency (RF) exposure limits set for an uncontrolled environment. This appliance should be installed and operated at a minimum separation distance of 20 cm between the antenna and your body.

Symbols on the device:



The symbol may be located on the compressor. It refers to the oil in the compressor and refers to the following danger: Can be fatal if swallowed or inhaled. This notice only applies for recycling. There is no danger during normal operation.



WARNING: Risk of fire / flammable materials. The symbol is located on the compressor and indicates the danger from flammable materials. Do not remove the label.



This label or a similar one may be located on the rear of the appliance. It refers to the foam panels in the door and/or the housing. This notice only applies for recycling. Do not remove the label.

Observe the warning messages and other detailed information in the other sections:

	DANGER	Indicates an immediately hazardous situation, which if not avoided, will result in death or serious injury.
	WARNING	Indicates a hazardous situation, which if not avoided, could result in death or serious injury.
	CAUTION	Indicates a hazardous situation, which if not avoided, could result in minor or moderate injury.

	NOTICE	Indicates a hazardous situation, which if not avoided, could result in damage to property.
	Note	Indicates useful advice and tips.

3 Start-up

3.1 Turning on the appliance

Make sure that the following requirements are met:

- Appliance is installed and connected according to installation instructions.
- All adhesive strips, adhesive and protective films, as well as transport safety devices in and on the appliance are removed.
- All advertising material has been removed from the drawers.



Fig. 2

- ▶ Switch on the appliance using the display.



Fig. 3

- ▶ Select the language.
- ▷ The status display appears.

The appliance starts in DemoMode:

If the appliance starts in DemoMode, you can deactivate DemoMode within the next 5 minutes.

Food management

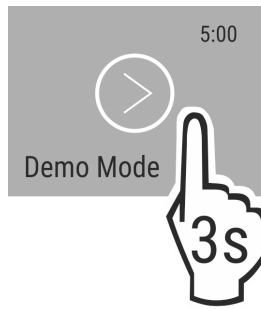

Fig. 4

- ▶ Press DemoMode for 3 seconds.
- ▷ DemoMode is deactivated.

Note

The manufacturer recommends:

- ▶ **Store frozen foods** at 0 °F (-18 °C) or colder.

3.2 Insert the equipment

- ▶ Insert the supplied equipment to help you make the most of the appliance.
- ▶ Install the SmartDevice app (see apps.home.liebherr.com).

Note

You can purchase accessories from the [Liebherr household appliance store](https://home.liebherr.com) (home.liebherr.com).

4 Food management

4.1 Storing food



WARNING

Danger of fire

- ▶ Do not use electrical appliances inside the food storage compartments of the appliance, unless they are of the type recommended by the manufacturer.

Note

Insufficient ventilation results in an increase in energy consumption and reduction of the refrigerating performance

- ▶ Always keep the air slots unobstructed.

When storing food, remember these basic rules:

- Do not obstruct the air vents on the back wall.
- Do not obstruct the air vents on the fan.
- Food is well sealed.
- Raw meat or fish is in clean, sealed containers so that other food cannot be touched or drip on them.
- Food is stored spaced apart to ensure good air circulation.

Note

Failure to follow these guidelines can lead to food perishing.

4.1.1 Freezer

This provides a dry, frosty storage climate at 0 °F (-18 °C). A frosty climate is suitable for storing frozen food and goods for several months, preparing ice cubes, or freezing fresh food.

Freezing food

You can freeze as many kilograms of fresh food within 24 hours as indicated on the nameplate (see 9.5 Rating plate) under "freezing capacity ... kg/24h".

To ensure that the food freezes quickly to the core, keep to the following quantities per pack:

- Fruit, vegetables up to 2.2 lb (1 kg)
- Meat up to 5.51 lbs (2.5 kg)

Before freezing, please note the following:

- SuperFrost is activated (see 6.3 Functions) when the amount of food to freeze exceeds approx. 4.41 lbs (2 kg).
- With a small volume of frozen goods: SuperFrost is activated approx. 6 hours prior.
- With the maximum volume of frozen goods: SuperFrost is activated approx. 24 hours prior.

Arranging the food:



CAUTION

There is a risk of injury from pieces of broken glass! Bottles and cans containing drinks can split or crack when frozen. This applies in particular to carbonated drinks.

- ▶ The *BottleTimer* function must be used when freezing bottles and cans with drinks.

For appliances smaller than 48-1/16 " (122 cm):

- With a small amount of frozen goods:
 - ▶ Distribute packaged groceries across all drawers.
 - ▶ If possible, place groceries at the back of the drawer near the rear wall.
- With the maximum amount of frozen goods:
 - ▶ Distribute packaged groceries across all drawers.
 - ▶ If possible, place groceries at the back of the drawer near the rear wall.

For appliances larger than or exactly 48-1/16 " (122 cm):

- With a small amount of frozen goods:
 - ▶ Distribute packaged groceries across all drawers, but do not place any groceries in the top drawer.
- With the maximum amount of frozen goods:
 - ▶ Distribute packaged groceries across all drawers.
 - ▶ If possible, place groceries at the back of the drawer near the rear wall.

For all appliances:

- With the maximum amount of frozen goods:
 - ▶ Once SuperFrost activates automatically, place food into the drawer.

Defrosting food

- in the fridge compartment

- in the microwave
- in the oven/fan oven
- at room temperature



WARNING

Danger of food poisoning!

► Do not re-freeze defrosted food.

- Remove only the food you need for now.
- Use defrosted food as quickly as possible

Freezer tray

Use the freezer tray for berries, herbs, vegetables and other small goods without them freezing together in the process. The food keeps its shape and is easier to separate into portions later on.

You can also store the freezer packs in the freezer tray to save space.*

- Spread food, unsealed, at a good distance apart, over the whole surface of the freezer tray.

4.2 Storage times

The storage times given are guidelines

Food with a “use by” date must still be consumed by the date indicated on the package

Guidelines for storage periods for various foods		
Ice cream	at 28 °F (-18 °C)	2 to 6 months
Sausage, ham	at 28 °F (-18 °C)	2 to 3 months
Bread, bakery products	at 28 °F (-18 °C)	2 to 6 months
Game, pork	at 28 °F (-18 °C)	6 to 9 months
Fish, fatty	at 28 °F (-18 °C)	2 to 6 months
Fish, lean	at 28 °F (-18 °C)	6 to 8 months
Cheese	at 28 °F (-18 °C)	2 to 6 months
Poultry, beef	at 28 °F (-18 °C)	6 to 12 months
Vegetables, fruit	at 28 °F (-18 °C)	6 to 12 months

5 Energy saving

- Always ensure good ventilation. Keep clear of obstruction all ventilation openings in the appliance enclosure or in the structure for building-in.
- Never block air slits in the fan.

- Do not install the appliance in direct sunlight or next to a stove, heater or similar heat source.
- Energy consumption depends on installation conditions such as the ambient temperature (see 1.4 Range of appliance use) . A warmer ambient temperature can increase the energy consumption.
- Avoid opening the appliance door for any longer then necessary
- The lower the temperature is set the higher the energy consumption.
- All food stored in the appliance should be well wrapped and covered. This prevents frost buildup.
- Insertion of warm foods: first let the food cool down to room temperature.

6 Use

6.1 Controls and displays

The display provides a quick overview of the temperature setting and the status of functions and settings. You can control the functions and settings either by deactivating/activating them or by selecting a value.

6.1.1 Status display

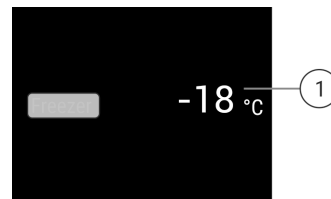

Fig. 5

(1) Temperature display

The Status display shows the set temperatures and is the home display. From there, you can navigate to the options and settings.

6.1.2 Navigation

Navigate in the menu to access the individual functions. An audible signal sounds after confirming a function or setting. If no selection is made after 10 seconds the display switches to the Status display.

The appliance is operated by swiping and confirming in the display:



Fig. 6

Use

Back:





- Confirm your selection in the submenu. The display returns to the menu.
- Select . The display returns to the function/setting.

Back to Status display:

- Close and open the door.
- Wait 10 seconds. The display changes to the Status display.

6.1.3 Display symbols





The display symbols provide information about the current appliance status.

Symbol	Appliance status
	Standby The appliance or temperature zone is turned off.
	Flashing number Appliance is working. Temperature flashes until the set temperature is reached.
	
	Flashing symbol Appliance is working. Setting is made.
	

6.2 Operating logic

6.2.1 Activating/deactivating settings

You can activate/deactivate the following functions:

Symbol	Function
	SuperFrost ^x
	IceMaker and MaxIce ^x
	PartyMode ^x
	EnergySaver

^x When a function is on, the appliance works harder. This means the appliance could make louder noises and consume more energy.

- ▶ Swipe left in the display until the function appears.
- ▶ Confirm selected function with a short tap.
- ▷ You hear the confirmation tone.
- ▷ Status appears in the menu.

▷ Function is on/off.

6.2.2 Selecting function value

With the following functions you can set a value in the submenu:

Symbol	Function
	Setting the temperature Switch the appliance on/off







- ▶ Swipe left in the display until the function appears.
- ▶ Confirm selected function with a short tap.
- ▶ Select the setting value by swiping the display.

Setting the temperature

- ▶ Confirm selected value with a short tap.
- ▷ You hear the confirmation tone.
- ▷ The display changes to blue when it is activated.
- ▷ Display switches back to the menu.

6.2.3 Activating/deactivating settings

You can activate/deactivate the following settings:

Symbol	Setting
	WiFi ¹
	Entry lock ²
	SabbathMode ²
	Reminders ¹
	Reset ²
	Switch off ²

- ▶ Swipe left in the display until Settings  appears.
- ▶ Confirm settings by tapping.
- ▶ Swipe until you can see the setting you want.

¹ Activate setting (short press)





- ▶ Tap briefly to confirm.
- ▷ You hear the confirmation tone.
- ▷ Status appears in the menu.
- ▷ Setting is activated / deactivated.

² Activate setting (long press)

- ▶ Press selection for 3 seconds to confirm.
- ▷ You hear the confirmation tone.
- ▷ Status appears in the menu.
- ▷ Display changes.

6.2.4 Selecting the setting value



With the following settings you can set a value in the submenu:



Symbol	Settings
	Brightness
	Door alarm
	Temp. unit
	Language

- ▶ Swipe the display to the left until the settings  are displayed.
- ▶ Confirm the settings by tapping.
- ▶ Swipe until you can see the setting you want.
- ▶ Tap briefly to confirm.
- ▶ Select the desired setting value by swiping the display.
- ▶ Tap briefly to confirm.
- ▷ You hear the confirmation tone.
- ▷ Status appears briefly in the submenu.
- ▷ Display switches back to the menu.

6.2.5 Calling up the customer menu

The customer menu provides the following settings:

Symbol	Function
	TubeClean ²
	Ice cube ¹
	Software

- ▶ Swipe left in the display until the settings  appear.
- ▶ Tap settings.
- ▷ The submenu appears.
- ▶ Swipe left in the display until the appliance information  appears.
- ▶ Press for 3 seconds.
- ▷ The input menu for a numerical code appears.
- ▶ Enter the numerical code 151.
- ▷ The customer menu appears.
- ▶ Swipe left in the display until the desired setting appears.

¹ Select the setting value

- ▶ Tap briefly to confirm.
- ▷ You hear the confirmation tone.
- ▷ Status appears briefly in the display.
- ▷ The display switches back to the menu.

² Activate setting

- ▶ To confirm, press the display for 3 seconds.
- ▷ You hear the confirmation tone.
- ▷ Status appears in the display.

- ▷ The symbol flashes as long as the appliance is working.

6.3 Functions

Temperature

The temperature depends on the following factors:

- the number of times the door is opened
- The duration the door is opened
- the room temperature of the installation location
- the type, temperature and amount of food

Freezer compartment	Recommended setting
	0 °F (-18 °C)

Setting the temperature

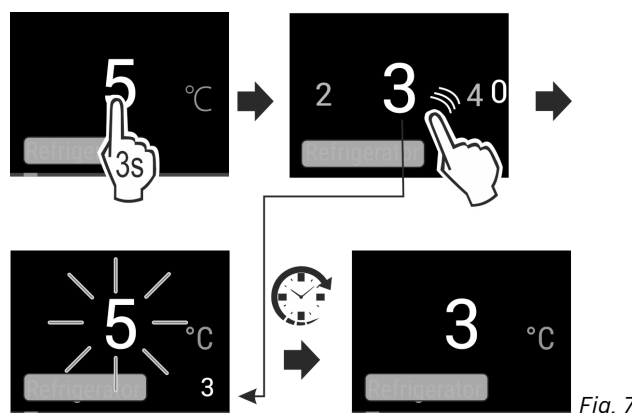

Fig. 7

- ▶ Set the value. (see 6.2 Operating logic) .
- ▷ The set temperature is shown on the bottom right of the display.

SuperFrost

Select this function for the maximum freezing setting, to reach lower freezing temperatures.

Use:

- To freeze more than 4.41 lbs (2 kg) fresh food a day.
- Freezing fresh food quickly to the core.
- Increasing the cold reserves in the stored goods before defrosting the appliance.

Activating/deactivating settings

With a small volume of frozen goods:

- ▶ Activate 6 hours before use.
- With the maximum volume of frozen goods:
- ▶ Activate 24 hours before use.
- ▶ Activating/deactivating (see 6.2 Operating logic) .
- or-
- ▶ Activate/deactivate using the SmartDevice app.

Use

The function automatically turns off. The appliance goes back to normal mode. The temperature adjusts itself to the set level.



PartyMode

This option offers an assortment of special functions and settings that are useful if you are having a party.

The following functions are activated:

- *SuperFrost*
- *IceMaker* and *MaxIce*

You can set any functions you like. Your changes are lost when the option is switched off.

Activating/deactivating settings

- ▶ Activating/deactivating (see 6.2 Operating logic) .
- ▷ On: All functions are activated at the same time.
- ▷ Deactivated: Previously set temperatures are restored.

The function is automatically switched off after 24 hours.



EnergySaver

This function reduces energy consumption. If you activate this function, the cooling temperature increases.

Temperature zone	Recommended setting	Temperature when EnergySaver activated
-18 °C	0 °F (-18 °C)	4 °F (-16 °C)

Use:

- Save energy.

Activating/deactivating settings

- ▶ Activating/deactivating (see 6.2 Operating logic) .
- ▷ Activated: Higher temperatures are set in all temperature zones.
- ▷ Deactivated: Previously set temperatures are restored.



IceMaker / MaxIce

This function activates the production of ice cubes.

Use:

- If this function is activated, you can decide between the normal IceMaker function and MaxIce.
- The MaxIce makes approx. 1.5 kg of ice cubes per 24 h within a short time.

The ice cube size can be set with the **ice cube size** function. (see Ice cubes)

The lines can be cleaned with the **TubeClean** function. (see TubeClean)

Activating the function

Make sure that the following requirements are fulfilled:

- The water supply is established at the fixed water connection. See Assembly Manual.*
- IceMaker is put into operation. (see 7.3 IceMaker)
- ▶ Activate the function. (see 6.2 Operating logic)

-or-

- ▶ Activate via the Liebherr SmartDevice-App.

- ▷ It can take up to 24 hours for the first ice cubes to be made.

Deactivating the function

- ▶ Deactivate the function. (see 6.2 Operating logic)
- or-
- ▶ Deactivate the function via the Liebherr SmartDevice-App.

- ▷ If ice cubes are currently being made, the system completes the process. After that, the IceMaker switches off.

6.4 Settings



Language

This setting lets you choose the language of the display.

Choose from the following languages:

- German
- English
- French
- Spanish
- Italian
- Dutch
- Czech
- Polish
- Portuguese
- Russian
- Chinese

Activating/deactivating settings

- ▶ Activating/deactivating (see 6.2 Operating logic) .



Setting up the WLAN connection

This setting connects the appliance to the internet. The connection is managed in the SmartDevice Box. You can use the SmartDevice-App to add your appliance to a SmartHome-System. Use the SmartDevice-App or other compatible partner networks to enjoy advanced options and settings.

Note

The SmartDevice Box is available from the [Liebherr Residential Appliances Store \(https://home.liebherr.com/shop/de/deu/smartdevice-box.html\)](https://home.liebherr.com/shop/de/deu/smartdevice-box.html).

More information about the availability, prerequisites and individual options can be found on the Internet at <https://smartdevice.liebherr.com/install>.

Use:

- Manage the appliance with the SmartDevice-App or a compatible partner network.
- Enjoy advanced functions and settings.
- Check the appliance status on the SmartDevice-App.

❑ Install the SmartDevice app (see <https://apps.home.liebherr.com/>).

Setting up the WLAN connection

Fig. 8

- ▶ Activate (see 6.2 Operating logic).
- ▷ The connection is set up: Connecting appears. The symbol flashes.
- ▷ The connection is set up: WiFi appears, the display turns blue.
- ▷ The connection failed: WiFi Error appears.

Disconnecting

- ▶ Deactivate the setting (see 6.2 Operating logic).

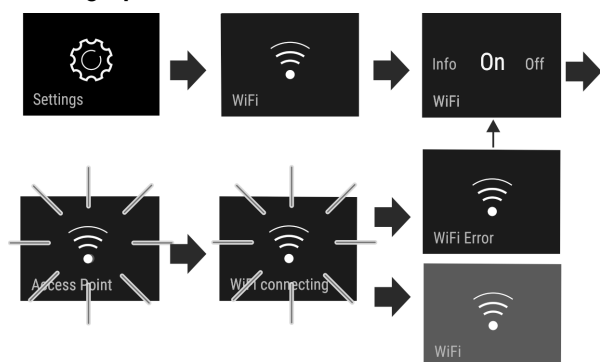
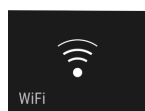
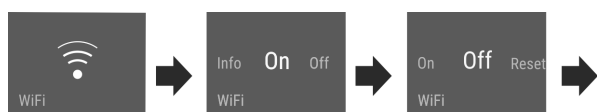



Fig. 9

- ▷ There is no connection: The symbol  is displayed constantly.

Restoring the connection

- ▶ Restore settings (see 6.2 Operating logic).

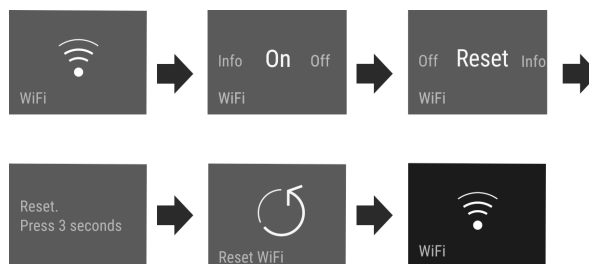

Fig. 10

- ▷ Connection and other settings are restored to factory settings.

**Entry lock**

This setting avoids accidental operation of the appliance, e.g. by children.

Use:

- Avoid unintentional changing of settings and functions.
- Avoid unintentional switching off of the appliance.
- Avoid unintentional temperature adjustments.

Activating/deactivating settings

- ▶ Activating/deactivating (see 6.2 Operating logic).

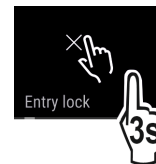
**Display brightness**

With this setting, you can choose a brightness level for the display.

You can set the following brightness levels:

- 40%
- 60%
- 80%
- 100%

Choosing the setting

- ▶ Set the level (see 6.2 Operating logic).

**Door alarm**

Set the time before the door alarm (see Close the door) sounds.

Options are as follows:

- 1 min
- 2 min
- 3 min
- Off

Choosing the setting

- ▶ Set the level (see 6.5 Error messages).

Use



Temperature unit

This setting allows you to change between Celsius and Fahrenheit as the temperature unit.

Selecting the setting value

- ▶ Set the value (see 6.2 Operating logic) .



Info

This setting allows the appliance information to be read out as well as access to the customer menu.

It provides the following information:

- Model name
- Index
- Serial number
- Service number

View appliance data

- ▶ Swipe in the display until Settings  appears.
- ▶ Confirm the display.
- ▶ Swipe in the display until About appears.
- ▶ Read the appliance data.



SabbathMode

This setting meets the religious requirements on the Sabbath and Jewish festivals. Turn on SabbathMode to switch off certain controls. This means you can use the appliance without anyone changing any settings.

You can find a list of Star-K-certified appliances at www.star-k.org/appliances.



WARNING

Danger of food poisoning!

If there is a power outage when SabbathMode is on, this message is not saved. When the power is restored, the appliance continues in SabbathMode. Afterwards, the temperature display does not show a message about the power outage.

If there was a power outage during SabbathMode:

- ▶ Check the quality of the food. Do not consume spoiled food!

What the appliance does in SabbathMode:

- The Status display continuously shows SabbathMode.
- The display is locked for all functions apart from deactivating SabbathMode.
- Any functions/settings that are already on, remain active.
- The display stays bright when the door is closed.
- Reminders are disabled. The set timer interval is also stopped. The function is no longer executed in SabbathMode.

- Reminders and warnings are not displayed. No acoustic signals are emitted and the display does not show warnings / settings such as temperature alarm or door alarm.
- IceMaker is out of use.
- The internal light is off.
- The defrost cycle only works for the specified time without taking account of fridge use.
- After a power cut the appliance automatically returns to SabbathMode.

Activating/deactivating SabbathMode

- ▶ To activate this function, swipe the display until you reach Settings  and press for 1 second. The menu shows the available settings.
- ▶ Swipe the display until the symbol for SabbathMode (Menora) appears. Press the symbol for 3 seconds.
 - ▷ The display changes color.
 - ▷ SabbathMode has been activated.

To deactivate the function, press the display for 3 seconds.

SabbathMode has been deactivated.



TubeClean

This setting cleans the IceMaker pipes.

Make sure that the following requirements are met:

- IceMaker cleaning process is ready (see 8.2.4 Cleaning the IceMaker) .

Activate setting

- ▶ Activate the setting in the customer menu (see 6.2 Operating logic) .
 - ▷ TubeClean is prepared (max. 60 min.): The symbol flashes.
 - ▷ Water pipes are rinsed: Symbol flashes.
 - ▷ Rinsing process is complete: Function turns off automatically.



Ice cubes

With this setting, you can choose the ice cube size.

Choosing the setting

- ▶ Make your settings in the Customer menu (see 6.2 Operating logic) .



Reminder

Reminders are displayed acoustically by a beep and visually by a symbol in the display. The signal gets louder until the alert stops.

Activate setting

- ▶ Activating/deactivating (see 6.2 Operating logic) .



Reset

This function resets all settings to the factory settings. All settings that you have made thus far will be reset to their original values.

Activate the setting

- ▶ Activating (see 6.2 Operating logic) .



Turn off appliance

This setting turns off the whole appliance.

Switch off whole appliance

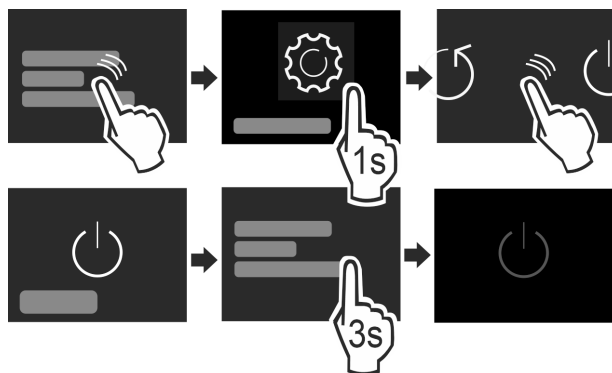

Fig. 11

- ▶ Turning off the IceMaker .
- ▶ Activating/deactivating (see 6.2 Operating logic) .
- ▷ Off: Display turns black.

6.5 Error messages

Error messages appear in the display. There are two categories of error message:

Category	Meaning
Message	Reminder of general procedures. You can carry out these procedures to eliminate the message.
Warning	Appears when there are malfunctions. A signal sounds in addition to the display. The signal becomes louder until you acknowledge by tapping the display. You can eliminate simple defects yourself. For more serious defects, you must contact customer service.

6.5.1 Warnings



Close the door

This message appears if the door is open too long. You can set the time before this message appears .

- ▶ Stop alarm: Confirm the message.

-or-

- ▶ Close the door.



Power failure.

This message appears if the freezer temperature rises after a power outage. When the power outage is over, the appliance will continue to operate at the last temperature setting.

- ▶ Stop alarm: Confirm the message.
- ▷ Temperature alarm appears (see Temperature alarm) .



Temperature alarm

This message appears if the temperature does not match the set temperature.

Temperature differences may be caused by:

- Hot fresh food was placed in the appliance.
- When sorting and removing food from the appliance, too much warm ambient air got in.
- There has been a prolonged power outage.
- The appliance is faulty.

When the cause is eliminated, the appliance will continue to operate at the last temperature setting.

- ▶ Confirm the display.
- ▷ Warmest temperature is displayed.
- ▶ Confirm the display again.
- ▷ The status display is displayed.
- ▷ Current temperature is displayed.



Error

This message appears when there is a fault with the appliance. An appliance component has an error.

- ▶ Open the door.
- ▶ Take note of the error code.
- ▶ Confirm the message.
- ▷ The signal tone stops.
- ▷ The status display appears.
- ▶ Close the door.
- ▶ Contact customer service. (see 9.4 Customer service)

6.5.2 Message



Insert IceMaker drawer

This message appears if the IceMaker drawer is open.

- ▶ Push in the IceMaker drawer.
- ▷ The message disappears.
- ▷ The IceMaker produces ice cubes.

6.5.3 DemoMode

If "D" appears in the display, demo mode is on. This feature is designed for retailers. The cooling features are disabled.

Switching off DemoMode

When you see a time counting down:

Equipment

- ▶ Confirm within the countdown.
- ▷ DemoMode is off.
If there is no countdown:
- ▶ Disconnect the power plug.
- ▶ Reconnect the power plug.
- ▷ DemoMode is off.

7 Equipment

7.1 Drawers

You can remove the drawers for cleaning.

The shelves below can be used for storage until the drawers are replaced.

How the drawers are removed and inserted differs depending on the pull-out system. Your appliance can include a variety of pull-out systems.

Note

Insufficient ventilation results in an increase in energy consumption and reduction of the refrigerating performance.

- ▶ Leave the bottom drawer in appliance!
- ▶ Never obstruct the vents on the interior rear wall!

7.1.1 Remove the drawer

Drawer without pull-out system

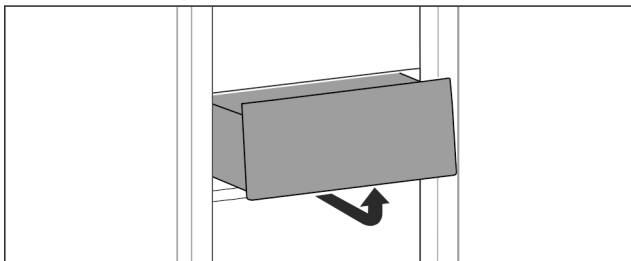

Fig. 12

- ▶ Remove the drawer as shown in the diagram.

Drawer on telescopic rails

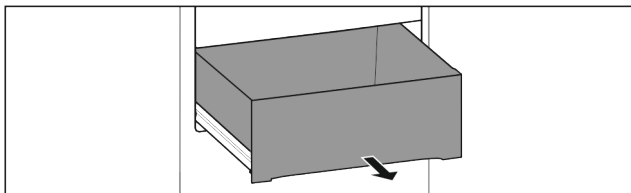

Fig. 13

Make sure that the following requirements are fulfilled:

- Drawer is completely pulled out (see Fig. 47) .

Drawer on glass shelf

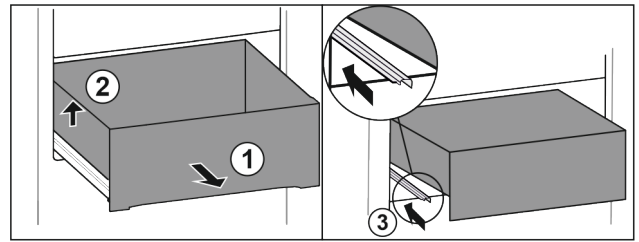

Fig. 14

- ▶ Pull drawer out completely Fig. 14 (1).
- ▶ Lift drawer on the left Fig. 14 (2).
- ▶ Slide in left rail Fig. 14 (3).

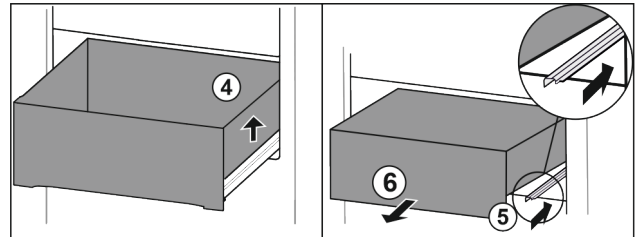

Fig. 15

- ▶ Lift drawer on the right Fig. 15 (4).
- ▶ Slide in right rail Fig. 15 (5).
- ▶ Remove the drawer to the front Fig. 15 (6).

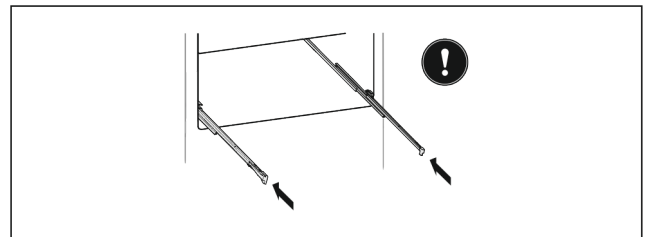

Fig. 16

If the rails are not yet fully pushed in after removing the drawer:

- ▶ Push the rails in completely.

Drawer on molded ribs

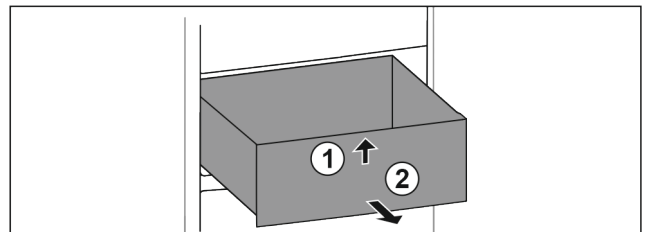

Fig. 17

- ▶ Pull drawer out completely.
- ▶ Lift at the front Fig. 17 (1).
- ▶ Remove to the front Fig. 17 (2).

Tilting top drawer

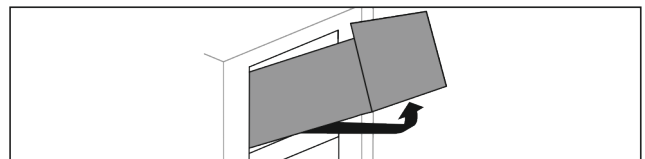

Fig. 18

- ▶ Pull out the drawer.
- ▶ Lift up at the front and push up at the back from below.
- ▶ Take off to the front.

7.1.2 Inserting the drawer

Drawer without pull-out system

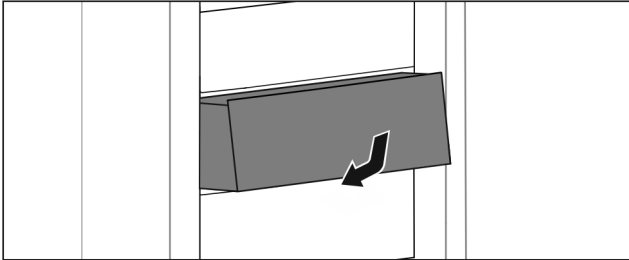

Fig. 19

- ▶ Insert the drawer as shown in the diagram.

Drawer on telescopic rails

Drawer on glass shelf

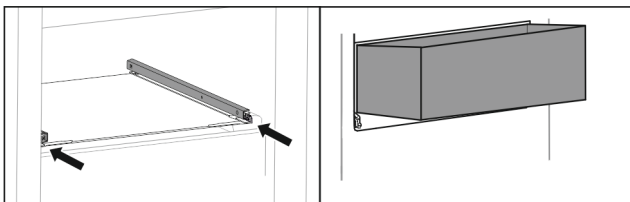

Fig. 20

- ▶ Slide the rails in.
- ▶ Place the drawer on the rails at an angle.

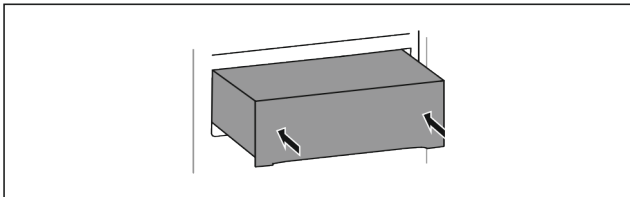

Fig. 21

- ▶ Lower.
- ▶ Push all the way back.

Drawer on molded ribs

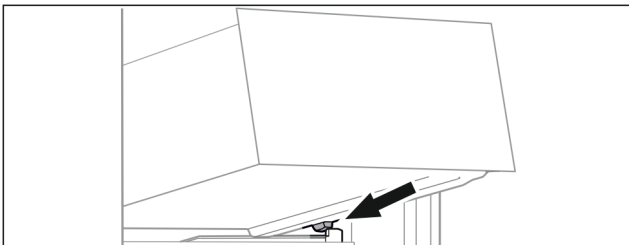

Fig. 22

- ▶ Place drawer on the molded ribs behind the stoppers with the drawer tilted up at the front Fig. 22 () .
- ▶ Lower drawer.
- ▶ Slide to the rear.

Tilting top drawer

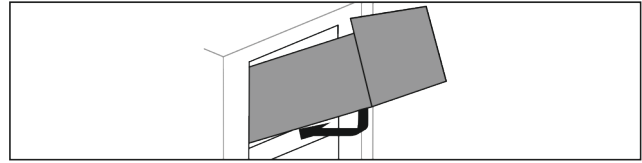

Fig. 23

- ▶ Place on the drawer as shown in the diagram.
- ▶ The drawer rests on the glass panel.
- ▶ Lift up slightly at the back and slide over the lip.
- ▶ Slide to the rear.

7.2 Pull-out board with IceTower

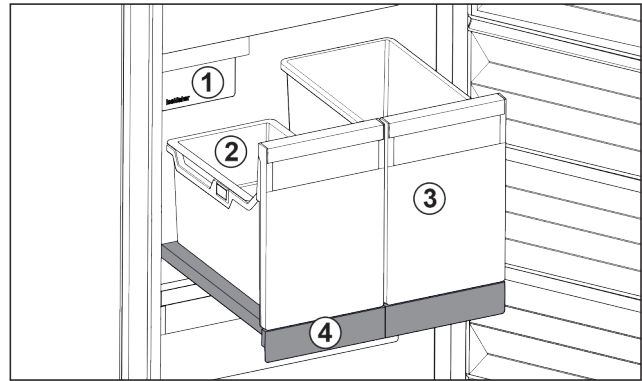

Fig. 24 Pull-out board with IceTower

- | | |
|---------------------------------------|--|
| (1) IceMaker | (3) Container for pizza or alcoholic beverages, for example |
| (2) Hang-on tray for ice cubes | (4) Pull-out board |

On the pull-out board are two tall containers (IceTower). Ice cubes from the IceMaker are collected and stored in the container Fig. 24 (2). The container Fig. 24 (3) is suitable for storing tall foodstuffs or beverages such as pizzas or alcoholic drinks.

The pull-out board with IceTower is mounted on a glass shelf with pull-out rails. You can dismantle the pull-out board for cleaning.

7.2.1 Dismantling the pull-out board with IceTower

Removing the container

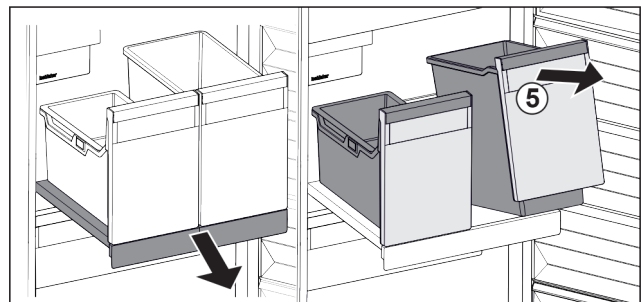

Fig. 25

- ▶ Remove the pull-out board.

Equipment

- ▶ Lift the container *Fig. 25 (5)* at the front.
- ▶ Remove the container.

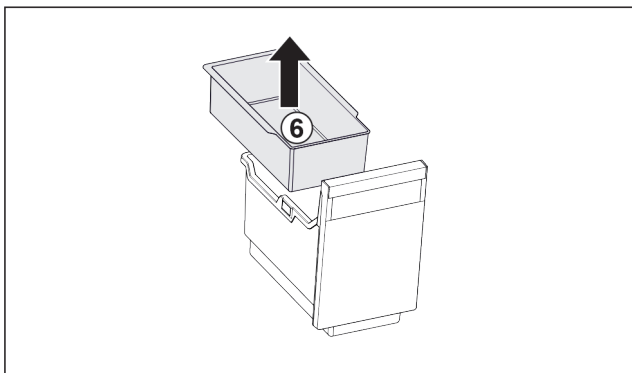

Fig. 26

- ▶ Remove the hang-on tray *Fig. 26 (6)*.
- ▶ If there are ice cubes in the hang-on tray: Empty the hang-on tray.
- ▷ The container and hang-on tray have been removed and you can clean them. (see 8.2.3 Cleaning the equipment)

Removing the pull-out board

Make sure that the following requirements are fulfilled:

- Containers have been removed. (see 7.2.1.1 Removing the container)

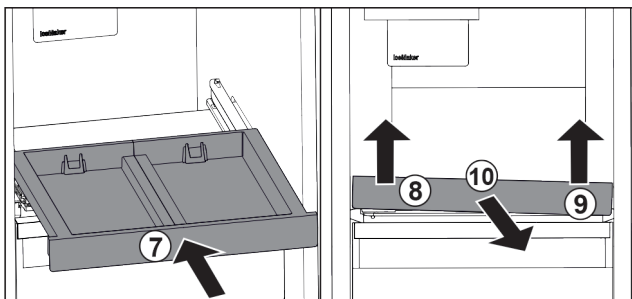

Fig. 27

- ▶ Slide in the pull-out board. *Fig. 27 (7)*
- ▶ Lift the pull-out board at the front left. *Fig. 27 (8)*
- ▶ Lift the pull-out board at the front right. *Fig. 27 (9)*
- ▷ The pull-out board is detached from the attachment at the front.
- ▶ Take out the pull-out board to the front. *Fig. 27 (10)*
- ▷ The pull-out board has been removed and you can clean it. (see 8.2.3 Cleaning the equipment)

7.2.2 Inserting the pull-out board with IceTower

Inserting the pull-out board

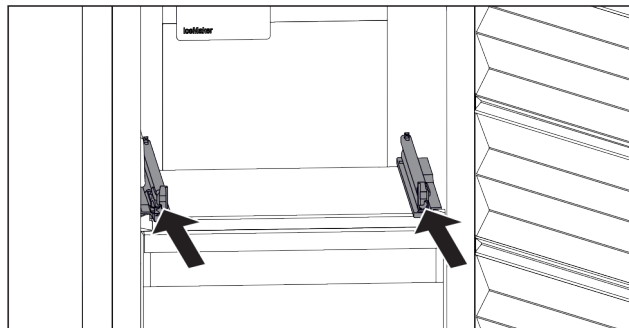

Fig. 28

- ▶ Slide the rails in.

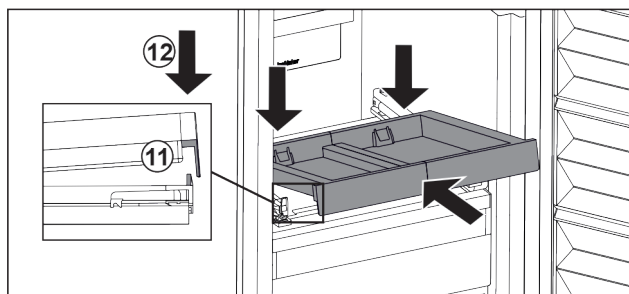

Fig. 29

- ▶ Place the pull-out board in at an angle behind the front lug.
- ▶ Slide it in at an angle. Make sure that the stop is behind the lug on both sides. *Fig. 29 (11)*
- ▶ Lower the pull-out board at the front. *Fig. 29 (12)*

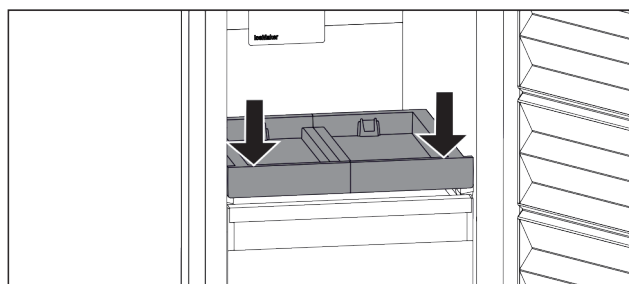

Fig. 30

- ▶ Push the pull-out board down at the front.
- ▷ The pull-out board clicks into place.

Inserting the container

Make sure that the following requirements are fulfilled:

- The pull-out board is inserted. (see 7.2.2.1 Inserting the pull-out board)

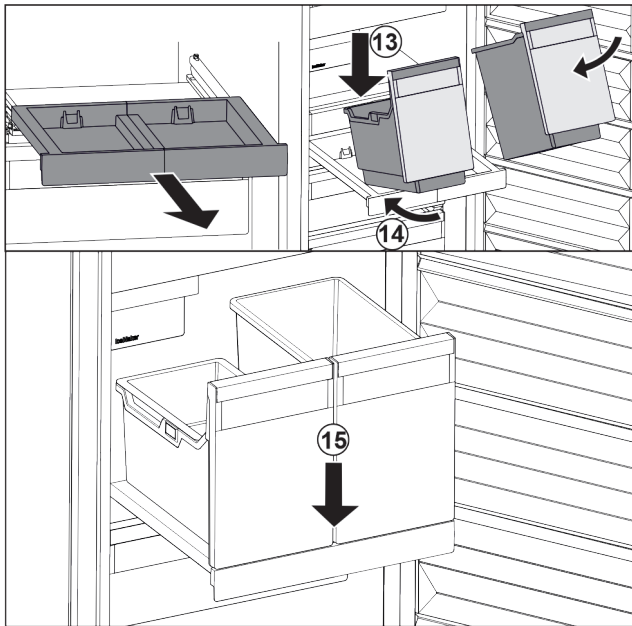

Fig. 31

- ▶ Remove the pull-out board.
- ▶ Hold the pull-out board with one hand.

Note

The containers are shaped in a way that they cannot be interchanged.

- ▶ Place the container at an angle on the pull-out board. *Fig. 31 (13)*
- ▶ Slide in the container at an angle to the back. *Fig. 31 (14)*
- ▶ Place container at the front. *Fig. 31 (15)*

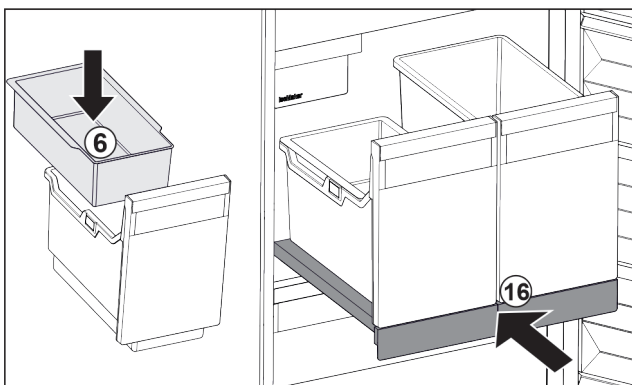

Fig. 32

- ▶ Insert hang-on tray *Fig. 32 (6)* for ice cubes.
- ▶ Slide in the pull-out board with container (IceTower). *Fig. 32 (16)*
- ▶ Pull-out board with IceTower is fully inserted.

7.3 IceMaker

The IceMaker is used exclusively for the production of ice cubes in household quantities.

Make sure that the following conditions are fulfilled

- IceMaker is cleaned (see 8 Maintenance).
- IceMaker drawer is fully inserted.

7.3.1 Producing ice cubes

The production capacity depends on the freezer temperature. The lower the temperature, the more ice cubes can be produced in a certain period.

Once IceMaker is switched on for the first time, it can take up to 24 hours to produce the first ice cubes.

- ▶ Activate the IceMaker (see 6.2 Operating logic).
- ▶ To make a large quantity of ice cubes: Activate the MaxIce (see 6.2 Operating logic).
- ▶ Distribute ice cubes evenly in the drawer to increase its capacity.
- ▶ Close the drawer: The IceMaker starts making ice again.

Note

When a certain level is reached in the IceMaker drawer, it stops making ice cubes. The IceMaker does not fill the drawer to the very top.

7.4 Accessories

7.4.1 Freezer packs

The freezer packs prevent the temperature from rising too fast in the event of a power failure.

The freezer packs are in the drawer.*

You can store the cold storage accumulators in the freezer tray.*

Using the freezer packs

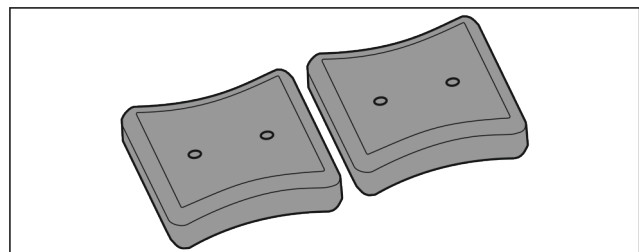

Fig. 33 *

When the freezer packs are fully frozen:*

- ▶ Place on the frozen goods in the top, front part of the freezer.*

8 Maintenance

8.1 Defrosting the appliance

8.1.1 Defrosting with NoFrost

Defrosting is performed automatically by the NoFrost system. The moisture condenses on the evaporator and is periodically defrosted and evaporated.

The appliance does not have to be defrosted.

Maintenance

8.2 Cleaning the appliance

8.2.1 Preparation



WARNING

Danger of electric shock.

- ▶ Unplug refrigerator or disconnect power.



WARNING

Danger of fire

- ▶ Do not damage the refrigerant circuit.

- ▶ Empty appliance.
- ▶ Pull out the power plug.

8.2.2 Cleaning the interior

NOTICE

Improper cleaning!
Damage to the appliance.

- ▶ Only use soft cleaning cloths and ph-neutral all-purpose cleaners.
 - ▶ Do not use steel wool or sponges that scour or scratch.
 - ▶ Do not use caustic or abrasive cleaning materials or those containing sand, chloride, or acids.
-
- ▶ Plastic surfaces: clean by hand with a soft clean cloth, lukewarm water and a little detergent.
 - ▶ Metal surfaces: clean by hand with a soft clean cloth, lukewarm water and a little detergent.
 - ▶ Drain outlet *D*: Remove any deposits with a thin item such as a cotton bud.

8.2.3 Cleaning the equipment

NOTICE

Improper cleaning!
Damage to the appliance.

- ▶ Only use soft cleaning cloths and ph-neutral all-purpose cleaners.
- ▶ Do not use steel wool or sponges that scour or scratch.
- ▶ Do not use caustic or abrasive cleaning materials or those containing sand, chloride, or acids.

Clean with a soft, clean cloth, lukewarm water and a little washing up liquid:

- IceTower pull-out board
- Drawer
Please note: Do not remove the magnet on the drawer. The magnet ensures that the IceMaker functions.
- Freezer tray

Clean with a damp cloth:

- Retracting rails

Please note: the grease in the tracks is there for lubrication purposes and must not be removed!

Clean in the dishwasher up to 140 °F (60 °C):

- Ice cube scoop
- ▶ Disassemble the equipment: see the relevant section.
- ▶ Clean the equipment.

8.2.4 Cleaning the IceMaker

There are various options for cleaning the IceMaker.

We recommend cleaning in the following situations:

- Initial commissioning
- If out of use for longer than 5 days.*

Make sure that the following requirements are met:

- IceMaker drawer is emptied.
- IceMaker drawer is fully inserted.
- The IceMaker has been activated. (see 6.2 Operating logic)

On first use or if not used for prolonged periods

Clean the IceMaker with TubeClean.

- ▶ Place a 50.72 fl oz (1.5 l) empty container (max. height 3-15/16 " (10 cm)) in the drawer under the IceMaker.
- ▶ Activate the TubeClean function. (see 6.2 Operating logic)
- ▷ The rinse process is prepared (max. 60 min.): The symbol flashes.
- ▷ Water pipes are rinsed: Symbol flashes.
- ▷ Rinsing process is complete: Function turns off automatically.
- ▶ Take out the IceMaker drawer and remove the container.
- ▶ Clean the IceMaker drawer with warm water and a little detergent.
- ▶ Push in the IceMaker drawer.
- ▷ Ice cube production starts automatically.
- ▶ Dispose of any ice cubes that are produced within 24 hours of the first ice cube production.

When cleaning is required

Clean the IceMaker manually.

- ▶ Remove the IceMaker drawer and clean with warm water and a little detergent.
- ▶ Push in the IceMaker drawer.
- ▷ Ice cube production starts automatically.

8.2.5 After cleaning

- ▶ Wipe dry the appliance and items of equipment
- ▶ Connect and switch on the appliance.
- ▶ Activate SuperFrost (see 6.3 Functions) .
When the temperature is sufficiently cold
- ▶ Place the food inside.
- ▶ Repeat cleaning regularly.

9 Customer support

9.1 Technical specifications

Temperature zone	
Freezing	-18 °F (-28 °C) to 5 °F (-15 °C)

Maximum freezing capacity / 24 hrs	
Freezer	See nameplate, "Freezing capacity ... /24h"

Max. equipment capacity			
Equipment	Appliance width 21-5/8 " (550 mm) (see installation instructions, appliance dimensions)	Appliance width 23-5/8 " (600 mm) (see installation instructions, appliance dimensions)	Appliance width 27-9/16 " (700 mm) (see installation instructions, appliance dimensions)
Drawer on glass shelf	26.46 lbs (12 kg)	33.07 lbs (15 kg)	--
Drawer on molded rib	30.86 lbs (14 kg)	41.89 lbs (19 kg)	55.12 lbs (25 kg)
Drawer on glass shelf	26.46 lbs (12 kg)	33.07 lbs (15 kg)	48.5 lbs (22 kg)

Ice cube production with IceMaker+	
Ice cube production / 24 h	At a temperature of 0 °F (-18 °C): 2.65 lbs (1.2 kg) of ice cubes
Maximum ice cube production / 24 h	When the MaxIce function is active: 3.31 lbs (1.5 kg) of ice cubes

For appliances with a WiFi connection:

Frequency specification	
Frequency band	2.4 GHz
Maximum radiated power	<100 mW
Purpose of the wireless equipment	Integration in the local WiFi network for data communication

9.2 Operating noises

The appliance makes noises while in operation.

- At **less cooling output** the appliance saves energy but takes longer to cool items. The volume is **lower**.
- At **a higher cooling output** the food cools more quickly. The volume is **higher**.

Examples:

- Activated functions (see 6.3 Functions)
- Running fan
- Freshly sorted food
- High ambient temperature
- Door opened for long periods

Noise	Possible cause	Type of noise
Bubbling and splashing	Coolant is flowing into the cooling circuit.	Normal noise
Spitting and hissing	Coolant is spraying into the cooling circuit.	Normal noise
Humming	The appliance cools. The volume depends on the cooling output.	Normal noise
Sipping noises	The self-closing door is being opened and closed.	Normal noise
Whirring and murmuring	The fan is running.	Normal operating noise
Clicking	Components are being switched on and off.	Normal switching noise
Rattling or humming	Valves are active.	Normal switching noise

Noise	Possible cause	Type of noise	How to resolve
Vibration	Unsuitable installation	Error noise	Check installation. Set up the appliance.
Clattering	Equipment, Objects inside the appliance	Error noise	Secure equipment parts. Leave a gap between items.

Customer support

9.3 Technical faults

Your appliance is designed and manufactured for reliable operation and a long service life. If a malfunction nonetheless occurs during operation, please check whether the malfunction is due to an operating error. In

this case, you will have to be charged for the costs incurred, even during the warranty period.

You may be able to rectify the following faults yourself.

9.3.1 Appliance function

Defect	Cause	Remedy
The appliance does not work.	The appliance is not switched on.	▶ Switch on the appliance.
	The power plug is not properly inserted in the wall socket.	▶ Check the power plug.
	The power fuse in the wall socket is not OK.	▶ Check the fuse.
	Power failure.	▶ Keep the appliance closed. ▶ Protect your food: Lay freezer packs on top of the food or use another freezer if the power is off for a prolonged period. ▶ Do not re-freeze defrosted food.
	The appliance connector is not correctly inserted in the appliance.	▶ Check the appliance connector.
The temperature is not cold enough	This means that the door of the appliance is not closed properly	▶ Close the appliance door
	Insufficient ventilation	▶ Clear and clean the ventilation grille.
	The ambient temperature is too high	▶ Solution: (see 1.4 Range of appliance use) .
	The appliance was opened too frequently or for too long	▶ Wait to see whether the required temperature resets itself by itself. If not, contact Customer Service (see 9.4 Customer service) .
	Too much fresh food was placed inside without SuperFrost.	▶ Solution: (see SuperFrost)
	The temperature is incorrectly set	▶ Set to a colder temperature and check after 24 hours.
	The appliance is too near to a heat source (stove, heater etc).	▶ Change location of appliance or the heat source.
	The appliance was not properly installed in the recess.	▶ Make sure the appliance was installed correctly and the door closes properly.
The door seal is defective or should be replaced for other reasons.	The door seal is interchangeable. You can replace it without the use of any special tools.	▶ Contact Customer Service (see 9.4 Customer service) .
The appliance is iced up or condensation is building.	The door seal may have slipped out of its groove.	▶ Check the door seal is well placed in the groove.

9.3.2 Equipment

Defect	Cause	Remedy
The IceMaker cannot be switched on.*	The appliance and therefore the IceMaker are not connected.	▶ Connect the appliance (see Installation Guide).
The IceMaker is not making any ice cubes.	The IceMaker is not switched on.	▶ Activate the IceMaker.
	The drawer of the IceMaker is not properly closed	▶ Close the drawer properly
	The water connection is not open*	▶ Open the water connection*
The interior light does not turn on.	The appliance is not switched on.	▶ Switch on the appliance.
	The door was open for longer than 15 min.	▶ The interior light automatically switches itself off if the door stays open for approx. 15 min.
	The LED interior light is faulty or the cover is damaged:	 WARNING Risk of injury from electrical shock. Live parts are under the cover. ▶ The LED interior light should only be replaced or repaired by the Customer Service department or by engineers trained to do so.

9.4 Customer service

First check if you can fix the error yourself (see 9 Customer support) . If this is not the case, please contact customer service.

Please refer to the enclosed "Liebherr Service" brochure for the address.



WARNING

Unprofessional repair!
Injuries.

- ▶ A damaged power cable may only be replaced by the manufacturer, the manufacturer's Customer Service or a similarly qualified person.
- ▶ For appliances with plug and play connection cables, the change can be made by the customer.

9.4.1 Contact Customer Service

Make sure to have the following appliance information to hand:

- Appliance name (model and index)
- Service no. (service)
- Serial no. (S no.)
- ▶ Showing appliance info on the display (see Info) .
- or-
- ▶ Referring to appliance info on the nameplate (see 9.5 Rating plate) .
- ▶ Take note of the appliance information.

- ▶ Inform Customer Service: Tell us the problem and the appliance details.
- ▷ This will help us give you fast and accurate support.
- ▶ Further instructions from customer service will follow.

9.5 Rating plate

The nameplate is located behind the drawers on the inside of the appliance.

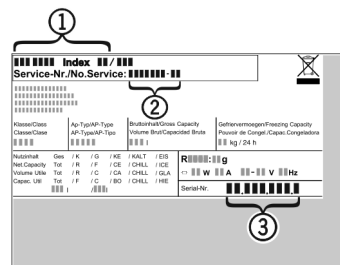

Fig. 34

- (1) Appliance name
- (2) Service no.
- (3) Serial no.
- ▶ Information from the nameplate.

10 Decommissioning

- ▶ Empty appliance.
- ▶ Switch off the IceMaker .
- ▶ Switch off the appliance (see 6.4 Settings) .
- ▶ Pull out the power plug.

Disposal

- ▶ Remove the appliance connector if necessary: Pull it out and, at the same time, move it from the left to the right.
- ▶ Clean the appliance (see 8.2 Cleaning the appliance).
- ▶ Leave the door open to prevent bad smells

11 Disposal

11.1 Preparing the appliance for disposal



WARNING

Risk of child entrapment!

Before you throw away your old refrigerator or freezer:

- ▶ Take off the doors.
- ▶ Leave the shelves in place so that children may not easily climb inside.



Li-Ion

Liebherr uses batteries in some of its appliances. You should remove these before disposal of the old appliance for environmental reasons. If your appliance contains batteries, a corresponding notice is attached to the appliance.

Lamps If you can remove the lamps yourself without destroying them, also remove these before disposal.

- ▶ Take the appliance out of operation.
- ▶ Appliance with batteries: Remove the batteries. For description, see **Maintenance** chapter.
- ▶ If possible: Remove lamps without destroying them.

11.2 Disposing of the appliance in an environmentally friendly manner



The appliance still contains valuable materials and must be collected separately from unsorted municipal waste so it can be recycled.



Dispose of batteries separately from the old appliance. Certain batteries should NOT go in household garbage or recycling bins. Waste batteries can always be recycled or taken to household hazardous waste collection points. To prevent fires from lithium-ion batteries, tape battery terminals and/or place batteries in separate plastic bags and never put these batteries in household garbage or recycling bins.

Lamps

Dispose of removed lamps via the respective collection systems.

For USA:

Check the Responsible Appliance Disposal (RAD) program to find a RAD partner near you.

For Canada:

Follow your local guidance about recycling and disposal capabilities near you.



WARNING

Leaking refrigerant and oil!

Fire. The refrigerant contained within the appliance is environmentally friendly, but flammable. The oil contained within the appliance is flammable. Escaping refrigerant and oil can ignite if they are of high enough concentration and are exposed to an external heat source.

- ▶ Do not damage the pipelines of the coolant circuit and the compressor.
- ▶ Transport the appliance away without damaging it.
- ▶ Dispose of batteries, lamps, and the appliance according to the above specifications.



home.liebherr.com/fridge-manuals

EN Built-in combined fridge-freezer

Issue date: 20220725

Part number index: 7088275-00

For Service in the U.S.: Liebherr Service Center
Toll Free: 1-866-LIEBHER or 1-866-543-2437
Service-appliances.us@liebherr.com
PlusOne Solutions, Inc.
3501 Quadrangle Blvd, Suite 120
Orlando, FL 32817

For Service in Canada: Liebherr Service Center
Toll Free: 1-888-LIEBHER or 1-888-543-2437
www.euro-parts.ca
EURO-PARTS CANADA
39822 Belgrave Road, Belgrave, Ontario, N0G 1E0
Phone: (519) 357-3320 | Fax: (519) 357-1326