

User Guide

Quality, Design and Innovation

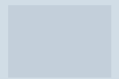



















home.liebherr.com/fridge-manuals



LIEBHERR

Contents

1	The appliance at a glance.....	3		Door alarm.....	17
1.1	Additional benefits.....	3		Entry lock.....	17
1.2	Delivered contents.....	3		Language.....	17
1.3	Overview of the appliance and its equipment.....	3		Info.....	17
1.4	SmartDevice.....	4		Reminder.....	17
1.5	Range of appliance use.....	4		Reset.....	17
1.6	Conformity.....	5			
2	General safety instructions.....	5			
3	Start-up.....	7			
3.1	Turning on the appliance.....	7			
3.2	Insert the equipment.....	8			
4	Food management.....	8			
4.1	Storing food.....	8			
4.2	Storage times.....	9			
5	Energy saving.....	11			
6	Use.....	11			
6.1	Controls and displays.....	11			
6.1.1	Status display.....	11			
6.1.2	Navigation.....	11			
6.1.3	Display symbols.....	12			
6.2	Operating logic.....	12			
6.2.1	Activating/deactivating settings.....	12			
6.2.2	Selecting function value.....	12			
6.2.3	Activating/deactivating settings.....	12			
6.2.4	Selecting the setting value.....	13			
6.2.5	Calling up the customer menu.....	13			
6.3	Functions.....	13			
	Turn off appliance.....	13			
	WiFi.....	13			
	Temperature.....	14			
	Temperature unit.....	14			
	BioFresh B-Value.....	14			
	SuperCool.....	15			
	PartyMode.....	15			
	HolidayMode.....	15			
	SabbathMode.....	15			
	EnergySaver.....	16			
	CleaningMode.....	16			
	Display brightness.....	16			
			6.4	Error messages.....	17
			6.4.1	Warnings.....	18
			6.4.2	DemoMode.....	18
7	Equipment.....	18			
7.1	Variable bottle shelf.....	18			
7.2	Drawers.....	19			
7.3	Fruit & Vegetable-Safe cover.....	19			
7.4	Humidity control.....	20			
7.5	Glass shelves.....	20			
7.6	Accessories.....	20			
8	Maintenance.....	22			
8.1	FreshAir carbon filter.....	22			
8.2	Disassembling / assembling pull-out systems.....	22			
8.3	Defrosting the appliance.....	23			
8.4	Cleaning the appliance.....	23			
9	Customer support.....	24			
9.1	Technical specifications.....	24			
9.2	Operating noises.....	24			
9.3	Technical faults.....	24			
9.4	Customer service.....	26			
9.5	Rating plate.....	26			
10	Decommissioning.....	26			
11	Disposal.....	26			
11.1	Preparing the appliance for disposal.....	26			
11.2	Disposing of the appliance in an environmentally friendly manner.....	27			

Congratulations on the purchase of your new appliance. With this purchase, you have chosen all the advantages of the latest refrigeration technology, guaranteeing you a high-quality appliance with a long life span and high operating safety.

The equipment of your appliance gives you the highest level of day-to-day ease of operation.





Together we are making an active contribution to the conservation of our environment by purchasing this appliance which is manufactured in an environmentally friendly process with the use of recyclable materials.

We hope you enjoy your new appliance.

The manufacturer is constantly working to improve all types and models. Therefore, please be aware that we

The appliance at a glance

reserve the right to make changes to the shape, equipment and technology.

Symbol	Explanation
	Read instructions Please read the information in these instructions carefully to understand all of the benefits of your new appliance.
	Check appliance Check all parts for transport damage. If you have any complaints, please contact your agent or customer service.
	Differences These instructions apply to a range of models, so there may be differences. Sections that apply to certain models only are indicated by an asterisk (*).
	Instructions and results Instructions are marked with a ▶. Results are marked with a ▷.
	Videos Videos about the appliances are available on the YouTube channel of Liebherr-Hausgeräte.

This User Guide applies to:

- IRBPd 5170
- IRBPdi 5170
- IRBP5170

1 The appliance at a glance

1.1 Additional benefits

- Natural coolant
- Energy-optimized refrigerant circuit
- Energy-efficient insulation
- Low energy consumption
- User-friendly electronic controls
- Active function indicators
- Temperature can be controlled in the appliance independent of ambient conditions according to its climate rating - Temperature can be displayed as °C or °F
- Large refrigeration capacity
- Safety glass storage shelves
- Bright LED interior light
- Door ajar alarm
- Integrated transport grips on appliance housing
- Transport castors at back
- Easy to clean
- Door hinges can be reversed
- Slider door system for easy installation in kitchen cabinets

- Door-on-door system for easy kitchen cabinet installation
- Soft stop mechanisms
- This appliance has a SabbathMode function, so you can use it on religious holidays. Further information can be found on the Star-K website www.star-k.org.

1.2 Delivered contents

Check all parts for damage during transport. If you have any complaints, please contact the dealer or Customer Service (see 9.4 Customer service).

Delivery contains the following parts:

- Integrated appliance
- Equipment (depending on your model)
- Installation parts (depending on your model)
- User Guide
- Installation Guide
- Warranty documents

1.3 Overview of the appliance and its equipment

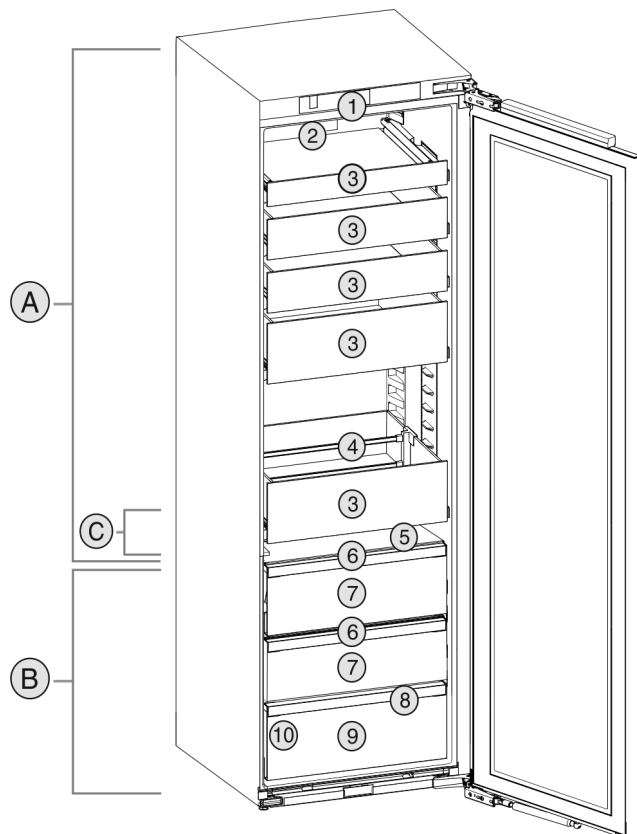

Fig. 1 Exemplary illustration

- Temperature zone**
- (A) Fridge
 - (B) BioFresh
 - (C) Coldest zone
- Equipment**

The appliance at a glance

- | | |
|--|----------------------------------|
| (1) Controls | (6) Fruit & Vegetable-Safe cover |
| (2) Fan with FreshAir active carbon filter | (7) Fruit & Vegetable-Safe |
| (3) Glass drawer | (8) Drainage outlet |
| (4) Bottle rack | (9) Meat & Dairy-Safe |
| (5) Variable bottle shelf | (10) Rating plate |



More information smartdevice.liebherr.com about SmartDevice:

The SmartDeviceBox is available from the Liebherr Service Center. The address for your respective country can be found on the back of the instructions.*

Downloading the SmartDevice app:



After installing and configuring the SmartDevice app, you can connect your appliance to the WiFi using the SmartDevice app and the WiFi appliance function (see WiFi).

Note

► The shelves, drawers, and baskets are arranged for optimal energy efficiency in the factory configuration. However, changes to the arrangement within the given insertion options – for example the arrangement of shelves in the fridge compartment – have no effect on energy consumption.

Notes on loading

<p>22 kg</p>	<p>50 kg</p>	<p>Maximum load of a single drawer, 22 kg (48 lb).</p> <p>The maximum total load must not exceed 50 kg (110 lb) when all drawers are pulled out at the same time.</p>
--------------	--------------	--

Fig. 2

1.4 SmartDevice

SmartDevice is the networking solution for your refrigerator.

If your appliance is SmartDevice-enabled or compatible, you can quickly and easily connect your appliance to your WiFi. With the SmartDevice app, you can operate your appliance from a mobile device. Additional functions and setting options are available in the SmartDevice app.

SmartDevice-enabled appliance:* Your appliance is equipped with the SmartDeviceBox. In order to connect your appliance to the WiFi, you need to download the SmartDevice app.*

SmartDevice-compatible appliance:* Your appliance is compatible for use with the SmartDeviceBox. You must first purchase and install the SmartDeviceBox. In order to connect your appliance to the WiFi, you need to download the SmartDevice app.*

1.5 Range of appliance use

Normal use

This appliance is intended to be used in household and similar applications such as,

- staff kitchen areas in shops, offices and other working environments;
- farm houses and by clients in hotels, motels and other residential type environments;
- bed and breakfast type environments;
- catering and similar non-retail applications.

The appliance is not suitable for freezing food; All other types of uses are not permitted.

Foreseeable misuse

The following uses are specifically prohibited:

- Storage and cooling of medication, blood plasma, laboratory preparations or similar substances and products in accordance with the CMDCAS and FDA 510(k)
- Use outdoors
- Use in moist areas exposed to the rain
- Use in outdoor areas with very high humidity
- Use in areas at risk of explosion

Incorrect appliance use can cause damage to the stored products or cause them to spoil.

Climate ratings

The appliance is set to operate within specific ambient temperature limits according to its

climate rating The climate rating for your appliance is printed on the rating plate

Note

► To guarantee trouble-free operation, comply with the indicated ambient temperatures.

Climate rating	for ambient temperatures from
SN	10 °C (50 °F) to 32 °C (90 °F)
N	16 °C (61 °F) to 32 °C (90 °F)
ST	16 °C (61 °F) to 38 °C (100 °F)
T	16 °C (61 °F) to 43 °C (109 °F)
SN-ST	10 °C (50 °F) to 38 °C (100 °F)
SN-T	10 °C (50 °F) to 43 °C (109 °F)

1.6 Conformity

The refrigerant circuit has been tested for leaks. When installed, the appliance complies with the applicable safety regulations and with the corresponding directives.

The BioFresh compartment meets the requirements of a cold storage compartment as set out in EN ISO 8561.

2 General safety instructions

Please keep these operating instructions in a safe place so you can refer back to them at any time.

If you pass the appliance on, please hand these operating instructions to the new owner.

Read and follow these instructions. They contain safety information which is important for safe and problem-free installation and operation. Always read and follow the safety information.

Dangers for the user:

- This appliance is not intended for use by persons (including children) with reduced physical, sensory or mental capabilities, or lack of experience and knowledge, unless they have been given supervision or instruction concerning use of the appliance by a person responsible for their safety. Children should be supervised to ensure that they do not play with the appliance. Cleaning and user maintenance must not be performed by children unless they are supervised. Children between the ages of 3 and 8 may load

and unload the appliance. Children under the age of 3 must be kept away from the appliance unless they are constantly supervised.

- **IMPORTANT:** The power plug must be easily accessible so that the appliance can be disconnected from the mains quickly in an emergency. It must not be behind the back of the appliance.
- The socket must be easily accessible so that the appliance can be disconnected quickly from the electricity in an emergency. It must not be located in the area behind the appliance.
- Always hold the appliance at the plug when disconnecting it from the household power. Do not pull on the cable.
- Disconnect the power plug or fuse if there is a malfunction.
- Do not damage the power cable. Do not operate the appliance with a faulty power cable. If the supply cord is damaged, it must be replaced by the manufacturer, its service agent or similarly qualified persons in order to avoid a hazard. For Plug and Play connections, the change may be carried out by the customer.
- Repairs and work on the appliance may only be carried out by Customer Service or other specifically trained qualified personnel.
- Only install, connect and dispose of the appliance in accordance with the instructions.
- Only operate the appliance after it has been installed.

Risk of fire:

- The refrigerant contained within the appliance (specifications on the identification plate) is environmentally friendly, but flammable. Leaking refrigerant can ignite.
 - **WARNING:** Do not damage the refrigerant circuit.
 - Do not handle ignition sources inside the appliance.
 - **WARNING:** Do not use electrical appliances inside the food storage compartments of the appliance, unless they are of the type recommended by the manufac-

General safety instructions

turer (e.g. steam cleaning appliances, heating appliances, ice cream makers).

- If refrigerant leaks: Remove naked flames or ignition sources located near the area of the leak. Ventilate the room well. Contact Customer Service.
- Do not operate the appliance near explosive gases.
- Do not store or use gasoline or other flammable gases and liquids near the appliance.
- Do not store explosive substances such as aerosol cans with a flammable propellant in this appliance. You can recognize such spray cans by the printed list of contents or by a flame symbol. Any leaking gases can be ignited by electrical components.
- Alcoholic beverages or other containers holding alcohol must always be tightly sealed for storage purposes. Any leaking alcohol can be ignited by electrical components.

Risk of falling or toppling over:

- **WARNING:** To avoid a hazard due to instability of the appliance, it must be fixed in accordance with the instructions.
- Do not stand on the base, drawers, doors etc. or use them as improper supports. This applies in particular to children.

Danger of poisoning:

- Do not consume spoiled food.

Danger of frostbite, feeling of numbness and pain:

- Avoid prolonged skin contact with cold surfaces or chilled/frozen food or take protective measures, e.g. wear gloves.

Risk of injury and damage:

- Hot steam may cause injuries. Do not use any electrical heating or steam cleaning equipment, naked flames or defrosting sprays for defrosting measures.
- **WARNING:** Do not use mechanical devices or other means to accelerate the defrosting process, other than those recommended by the manufacturer.
- Do not remove ice using sharp objects.

- **WARNING:** Keep clear of obstruction all ventilation openings in the appliance enclosure or in the structure for building-in.

- **WARNING:** Risk of child entrapment. Before you throw away your old refrigerator or freezer:

- Take off the doors.
- Leave the shelves in place so that children may not easily climb inside.

Risk of crushing:

- Do not hold onto the hinge when opening and closing the door. Fingers may become trapped.

California Proposition 65

- **WARNING:** This product can expose you to chemicals including Diisononyl Phthalate (DINP), which is known to the State of California to cause cancer, and Di-isodecyl Phthalate (DIDP), which is known to the State of California to cause birth defects or other reproductive harm. For more information, go to www.P65Warnings.ca.gov

FCC Warning*

- Changes or modifications not expressly approved by the party responsible for compliance could void the user's authority to operate the equipment.*

FCC information*

- This appliance has been tested and found to comply with the limits for a Class B digital device, pursuant to part 15 of the FCC Rules. These limits are designed to provide reasonable protection against harmful interference from an installation in residential areas. This appliance generates, uses and can radiate radio-frequency energy and, if not installed and used in accordance with the instructions, may cause harmful interference to radio communications. However, there is no guarantee that interference will not occur in a particular installation. If this appliance does cause harmful interference to radio or television reception, which can be determined by switching the appliance on and off, the user should try to correct the interference by one or more of the following measures:*

- Reorient or relocate the receiving antenna.*

- Increase the distance between the appliance and receiver.*
- Connect the appliance to an outlet on a circuit different from that to which the receiver is connected.*
- Consult the dealer or an experienced radio/TV technician for help.*

FCC Radio Frequency Exposure Statement*

- This appliance is found to comply with FCC radio frequency (RF) exposure limits set for an uncontrolled environment. This transmitter must not be set up or operated in conjunction with another antenna or another transmitter.*
- This appliance should be installed and operated at a minimum separation distance of 20 cm between the antenna and your body. The user must follow the specific operating instructions to comply with the limits of RF exposure.*

IC information*

- This appliance has license-exempt transmitters/receivers, which comply with the license-exempt Radio Standards Specification (RSS) of Innovation, Science and Economic Development Canada. Operation is subject to the following two conditions:*
 - This appliance may not cause interference.*
 - This device must accept any interference, including interference that may cause undesired operation of the device.*

IC Radio Frequency Exposure Statement*

- This appliance is found to comply with IC RSS-102 radio frequency (RF) exposure limits set for an uncontrolled environment. This appliance should be installed and operated at a minimum separation distance of 20 cm between the antenna and your body.*

Symbols on the device:



The symbol may be located on the compressor. It refers to the oil in the compressor and refers to the following danger: Can be fatal if swallowed or inhaled. This notice only applies for recycling. There is no danger during normal operation.





WARNING: Risk of fire / flammable materials. The symbol is located on the compressor and indicates the danger from flammable materials. Do not remove the label.



This label or a similar one may be located on the rear of the appliance. This label indicates that there are vacuum insulation panels (VIP) or perlite panels in the door and/or housing. This notice only applies for recycling. Do not remove the label.

Observe the warning messages and other detailed information in the other sections:

	DANGER	Indicates an immediately hazardous situation, which if not avoided, will result in death or serious injury.
	WARNING	Indicates a hazardous situation, which if not avoided, could result in death or serious injury.
	CAUTION	Indicates a hazardous situation, which if not avoided, could result in minor or moderate injury.
	NOTICE	Indicates a hazardous situation, which if not avoided, could result in damage to property.
	Note	Indicates useful advice and tips.

3 Start-up

3.1 Turning on the appliance

Make sure that the following requirements are met:

- Appliance is installed and connected according to installation instructions.
- All adhesive strips, adhesive and protective films, as well as transport safety devices in and on the appliance are removed.
- All advertising material has been removed from the drawers.

Food management

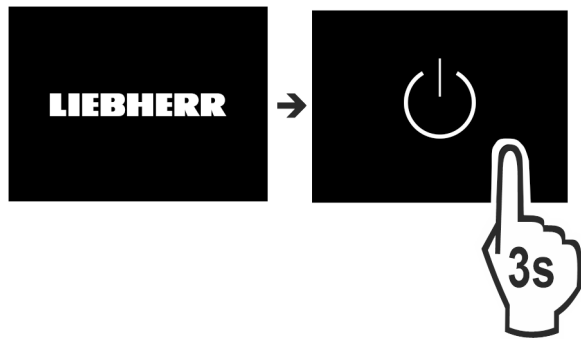

Fig. 3

- ▶ Switch on the appliance using the display.

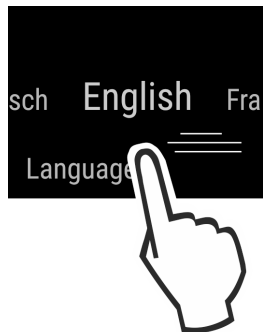

Fig. 4

- ▶ Select the language.
- ▷ The status display appears.

The appliance starts in DemoMode:

If the appliance starts in DemoMode, you can deactivate DemoMode within the next 5 minutes.

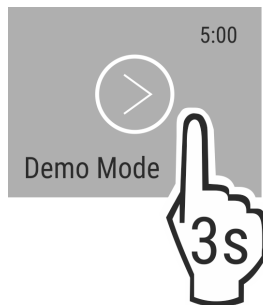

Fig. 5

- ▶ Press DemoMode for 3 seconds.
- ▷ DemoMode is deactivated.

Note

The manufacturer recommends:

- ▶ Place the food inside: Wait for around 6 hours until the set temperature is reached.

3.2 Insert the equipment

Note

Accessories can be purchased from the Liebherr Service Center. The address for your respective country can be found on the back of the instructions.

- ▶ Insert the supplied equipment to help you make the most of the appliance.

4 Food management

4.1 Storing food



WARNING

Danger of fire

- ▶ Do not use electrical appliances inside the food storage compartments of the appliance, unless they are of the type recommended by the manufacturer.

Note

Insufficient ventilation results in an increase in energy consumption and reduction of the refrigerating performance

- ▶ Always keep the air slots unobstructed.

When storing food, remember these basic rules:

- Do not obstruct the air vents on the back wall.
- Do not obstruct the air vents on the fan.
- Food is well sealed.
- Food that easily absorbs or emits odor or taste, are in sealed containers or are covered.
- Raw meat or fish is in clean, sealed containers so that other food cannot be touched or drip on them.
- Liquids are in sealed containers.
- Food is stored spaced apart to ensure good air circulation.

Note

Failure to follow these guidelines can lead to food perishing.

4.1.1 Fridge

The natural air circulation means the temperature varies in different sections.

Arranging the food:

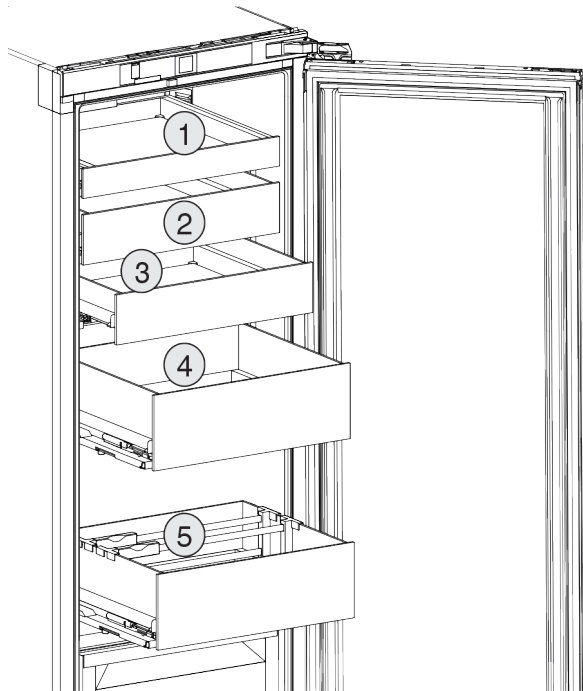

Fig. 6 Storage examples

- (1) Butter, eggs
- (2) Yogurt, quark
- (3) Foodstuffs in small jars or in small cans
- (4) Canned food, tins
- (5) Bottles, Tetra Paks

Note

Max. load of a single drawer in the refrigerator compartment: 22 kg (48.50 lb)

Max. load of the refrigerator compartment when all drawers are pulled out at the same time: 50 kg (110 lb) (see 1.3 Overview of the appliance and its equipment)

► Load drawers according to the size of the groceries.

4.1.2 BioFresh

BioFresh allows some fresh food to be stored longer compared to conventional cooling.

The taste, freshness, and nutritional value (vitamin B and C groups) of the food are preserved to a large extent. Fruit and vegetables spoil less quickly and lose less water, and food remains fresher and more wholesome.

Food with a “use by” date must still be consumed by the date indicated on the package.

Note

The temperature can drop to 0 °C (32 °F) which means foods could easily freeze.

► Store cold-sensitive vegetables such as cucumbers, aubergines, zucchini, and cold-sensitive tropical fruit, in the refrigerator compartment.

Fruit & Vegetable-Safe

This provides a fresh storage climate with the lid closed. A moist climate is suitable for storing unsealed food with a high moisture content (e.g. salad, vegetables, fruit).

The humidity depends on the moisture content of the stored items and how frequently the door is opened. You can regulate the moisture.

Arranging the food:

- Place unsealed fruit and vegetables.
- Excessive moisture: Regulate the air humidity (see 7.4 Humidity control).

Meat & Dairy-Safe

The DrySafe provides a relatively dry storage environment. A dry climate is suitable for dry or sealed food (e.g. dairy products, meat, fish, sausage).

Arranging the food:

- Place dry or sealed food.

4.2 Storage times

The storage times given are guidelines.

Food with a “use by” date must still be consumed by the date indicated on the package.

4.2.1 Fridge

The best-before date stated on the packaging applies.

4.2.2 BioFresh

Guideline storage times for the Meat & Dairy-Safe		
Butter	at 1 °C (34 °F)	up to 90 days
Hard cheese	at 1 °C (34 °F)	up to 110 days
Milk	at 1 °C (34 °F)	up to 12 days
Sausage, cold cuts	at 1 °C (34 °F)	up to 8 days
Poultry	at 1 °C (34 °F)	up to 6 days
Pork	at 1 °C (34 °F)	up to 6 days
Beef	at 1 °C (34 °F)	up to 6 days

Food management

Guideline storage times for the Meat & Dairy-Safe		
Game	at 1 °C (34 °F)	up to 6 days

Note

- Note that higher-protein foods spoil more quickly So, shellfish and crustaceans perish faster than fish, and fish perishes faster than meat.

Guideline storage times for the Fruit & Vegetable-Safe		
Vegetables, lettuce		
Artichokes	at 1 °C (34 °F)	up to 14 days
Celery	at 1 °C (34 °F)	up to 28 days
Cauliflower	at 1 °C (34 °F)	up to 21 days
Broccoli	at 1 °C (34 °F)	up to 13 days
Endives	at 1 °C (34 °F)	up to 27 days
Mâche	at 1 °C (34 °F)	up to 19 days
Peas	at 1 °C (34 °F)	up to 14 days
Kale	at 1 °C (34 °F)	up to 14 days
Carrots	at 1 °C (34 °F)	up to 80 days
Garlic	at 1 °C (34 °F)	up to 160 days
Cabbage turnip	at 1 °C (34 °F)	up to 14 days
Iceberg lettuce	at 1 °C (34 °F)	up to 13 days

Guideline storage times for the Fruit & Vegetable-Safe		
Herbs	at 1 °C (34 °F)	up to 13 days
Leeks	at 1 °C (34 °F)	up to 29 days
Mushrooms	at 1 °C (34 °F)	up to 7 days
Radishes	at 1 °C (34 °F)	up to 10 days
Brussels sprouts	at 1 °C (34 °F)	up to 20 days
Asparagus	at 1 °C (34 °F)	up to 18 days
Spinach	at 1 °C (34 °F)	up to 13 days
Savoy cabbage	at 1 °C (34 °F)	up to 20 days
Fruit		
Apricots	at 1 °C (34 °F)	up to 13 days
Apples	at 1 °C (34 °F)	up to 80 days
Pears	at 1 °C (34 °F)	up to 55 days
Blackberries	at 1 °C (34 °F)	up to 3 days
Dates	at 1 °C (34 °F)	up to 180 days
Strawberries	at 1 °C (34 °F)	up to 7 days
Figs	at 1 °C (34 °F)	up to 7 days

Guideline storage times for the Fruit & Vegetable-Safe		
Blueberries	at 1 °C (34 °F)	up to 9 days
Raspberries	at 1 °C (34 °F)	up to 3 days
Red currants	at 1 °C (34 °F)	up to 7 days
Cherries, sweet	at 1 °C (34 °F)	up to 14 days
Kiwi	at 1 °C (34 °F)	up to 80 days
Peaches	at 1 °C (34 °F)	up to 13 days
Plums	at 1 °C (34 °F)	up to 20 days
Cranberries	at 1 °C (34 °F)	up to 60 days
Rhubarb	at 1 °C (34 °F)	up to 13 days
Gooseberries	at 1 °C (34 °F)	up to 13 days
Grapes	at 1 °C (34 °F)	up to 29 days

5 Energy saving

- Always ensure good ventilation. Keep clear of obstruction all ventilation openings in the appliance enclosure or in the structure for building-in.
- Never block air slits in the fan.
- Do not install the appliance in direct sunlight or next to a stove, heater or similar heat source.
- Energy consumption depends on installation conditions such as the ambient temperature (see 1.5 Range of appliance use) . A warmer ambient temperature can increase the energy consumption.
- Avoid opening the appliance door for any longer then necessary
- The lower the temperature is set the higher the energy consumption.
- Sort your food items: home.liebherr.com/food.

- All food stored in the appliance should be well wrapped and covered. This prevents frost buildup.
- Only take food out for as long as necessary so that it does not get too warm.
- Insertion of warm foods: first let the food cool down to room temperature.
- For longer periods of absence, use HolidayMode (see HolidayMode) .

6 Use

6.1 Controls and displays

The display gives you a quick overview of the temperature setting and the status of functions and settings. Select or adjust functions by activating/deactivating or selecting a value.

6.1.1 Status display

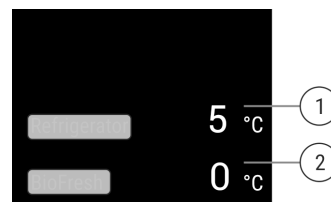

Fig. 7



- (1)** Fridge compartment temperature display **(2)** Temperature display BioFresh

The Status display shows the set temperatures and is the home display. From there, you can navigate to the options and settings.

6.1.2 Navigation



Navigate in the menu to access the individual functions. An audible signal sounds after confirming a function or setting. If no selection is made after 10 seconds, the display switches to the Status display.

Navigation	Description
	<p>Press briefly</p> <p>Activate/deactivate function. Confirm selection. Open submenu.</p>
	<p>Long press (3 seconds)</p> <p>Activate/deactivate function. Increasing/decreasing bar appears in the display. Confirm selection. Reset appliance/values. Switch appliance on/off.</p>

Navigation	Description
	Swipe Navigating in the menu. Search for values.
	Briefly press "Back" symbol Display goes back one level.
No action for 10 seconds	Display switches to the Status display.

6.1.3 Display symbols



The display symbols provide information about the current appliance status.

Symbol	Appliance status
	Standby The appliance or temperature zone is turned off.
	Flashing number Appliance is working. Temperature flashes until the set temperature is reached.
	Flashing symbol Appliance is working. Setting is made.

6.2 Operating logic

6.2.1 Activating/deactivating settings

You can activate/deactivate the following functions:



Symbol	Function
	SuperCool ^x
	PartyMode ^x
	HolidayMode

Symbol	Function
	EnergySaver

- ^x When function is on, the appliance works harder. This means appliance noise when operating may be louder for a short while, and more energy will be consumed.
- ▶ Swipe left in the display until the function appears.
- ▶ Confirm selected function with a short tap.
- ▷ You hear the confirmation tone.
- ▷ Status appears in the menu.
- ▷ Function is on/off.

6.2.2 Selecting function value







With the following functions you can set a value in the submenu:

Symbol	Function
	Setting the temperature
	Switch the appliance on/off

- ▶ Swipe left in the display until the function appears.
- ▶ Confirm selected function with a short tap.
- ▶ Select the setting value by swiping the display.
- ▶ Press briefly to confirm the selected value.

6.2.3 Activating/deactivating settings

You can activate/deactivate the following settings:

Symbol	Setting
	WiFi ¹
	Entry lock ²
	SabbathMode ²
	Cleaning Mode ²
	Reminders ¹
	Reset ²
	Switch off ²

- ▶ Swipe left in the display until Settings  appears.
- ▶ Confirm settings by tapping.
- ▶ Swipe until you can see the setting you want.

¹ Activate setting (short press)

- ▶ Tap briefly to confirm.
- ▷ You hear the confirmation tone.
- ▷ Status appears in the menu.





▷ Setting is activated / deactivated.

² Activate setting (long press)

- ▶ Press selection for 3 seconds to confirm.
- ▷ You hear the confirmation tone.
- ▷ Status appears in the menu.
- ▷ Display changes.

6.2.4 Selecting the setting value



With the following settings you can set a value in the submenu:



Symbol	Settings
	Brightness
	Door alarm
	Temp. unit
	Language

- ▶ Swipe the display to the left until the settings  are displayed.
- ▶ Confirm the settings by tapping.
- ▶ Swipe until you can see the setting you want.
- ▶ Tap briefly to confirm.
- ▶ Select the desired setting value by swiping the display.
- ▶ Tap briefly to confirm.
- ▷ You hear the confirmation tone.
- ▷ Status appears briefly in the submenu.
- ▷ Display switches back to the menu.

6.2.5 Calling up the customer menu

The customer menu provides the following settings:

Symbol	Function
	BioFresh B-Value ¹
	Software

- ▶ Swipe left in the display until the settings  appear.
- ▶ Tap settings.
- ▷ The submenu appears.
- ▶ Swipe left in the display until the appliance information  appears.
- ▶ Press for 3 seconds.
- ▷ The input menu for a numerical code appears.
- ▶ Enter the numerical code 151.
- ▷ The customer menu appears.
- ▶ Swipe left in the display until the desired setting appears.

¹ Select the setting value

- ▶ Tap briefly to confirm.
- ▷ You hear the confirmation tone.
- ▷ Status appears briefly in the display.
- ▷ The display switches back to the menu.

² Activate setting

- ▶ To confirm, press the display for 3 seconds.
- ▷ You hear the confirmation tone.
- ▷ Status appears in the display.
- ▷ The symbol flashes as long as the appliance is working.

6.3 Functions

Turn off appliance

This setting turns off the whole appliance.

Switch off whole appliance

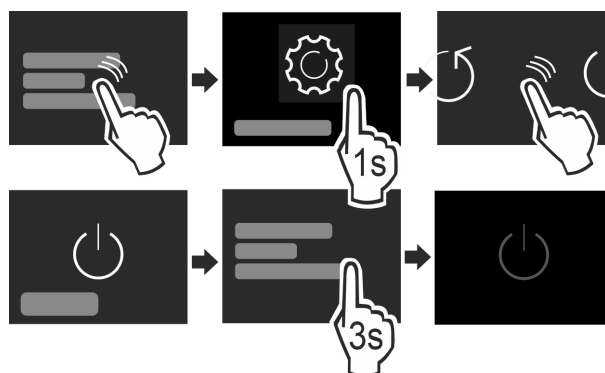

Fig. 8

- ▶ Activating/deactivating (see 6.2 Operating logic).
- ▷ Off: Display turns black.

WiFi

Use this function to connect your appliance to the WiFi. You can then operate it via the SmartDevice app on a mobile device. You can also use this function to disconnect or reset the WiFi connection. To connect your appliance to the WiFi, you need the SmartDeviceBox and how to use the SmartDevice app: (see 1.4 SmartDevice)

Note

You cannot use the SmartDeviceBox in the following countries: Russia, Belarus, Kazakhstan. The SmartDevice function is not available.

Establishing a WiFi connection

Make sure that the following requirements are fulfilled:

- You have a SmartDeviceBox and it is switched on. (see 1.4 SmartDevice) *
- You have installed the SmartDevice app (see apps.home.liebherr.com).
- Registration in the SmartDevice app is completed.

Use

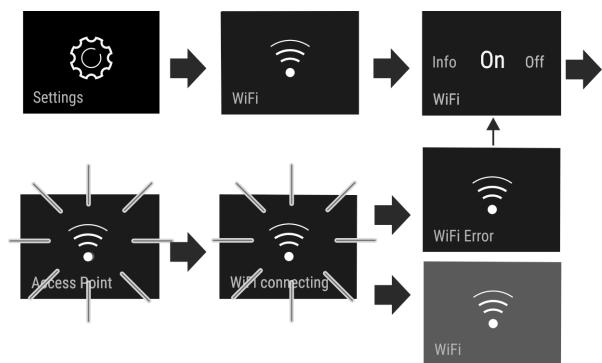

Fig. 9

- ▶ Activate the setting. (see 6.2 Operating logic)
- ▷ Connection is established: Connecting appears. The symbol flashes.
- ▷ Connection is established: WiFi appears, the display turns blue.
- ▷ Connection failed: WiFi Error appears.

Disconnecting from the WiFi

- ▶ Deactivate the setting. (see 6.2 Operating logic)

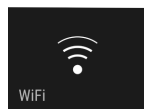
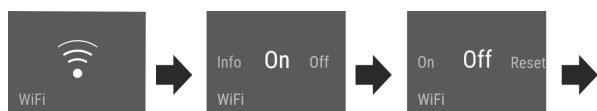



Fig. 10

- ▷ There is no connection: Symbol  is permanently visible.

Resetting the WiFi connection

- ▶ Reset settings. (see 6.2 Operating logic)

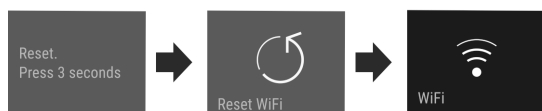
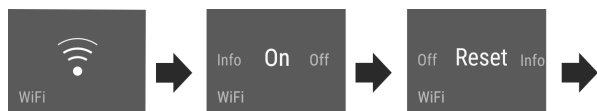

Fig. 11

- ▷ The connection and other settings are reset to the factory settings.

5 °C Temperature

The temperature depends on the following factors:

- the number of times the door is opened
- The duration the door is opened

- the room temperature of the installation location
- the type, temperature and amount of food

Temperature zone	Recommended setting
5 °C Fridge	5 °C 41 °F
0 °C BioFresh	(see BioFresh B-Value)

Setting the temperature in the refrigerator compartment

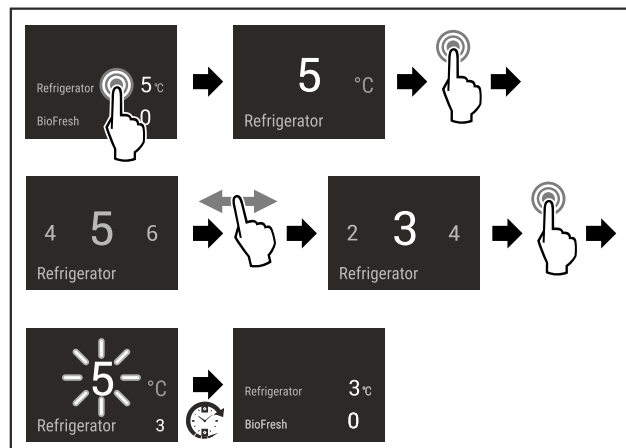

Fig. 12

- ▶ Complete the steps.
- ▷ Temperature is set.

Setting the temperature in the BioFresh

You can set the temperature using the **BioFresh B-Value** in the customer menu. (see BioFresh B-Value)

°C/°F Temperature unit

This setting allows you to change between Celsius and Fahrenheit as the temperature unit.

Selecting the setting value

- ▶ Set the value (see 6.2 Operating logic).

B5 BioFresh B-Value

In the delivery condition of the appliance, the value is set to **B5**. The status indicator on the display shows the appropriate target temperature in the BioFresh.

You can change this value slightly if a higher or lower ambient temperature makes it necessary. When setting the value, note:

Value	Description
B1	Lowest temperature
B1-B4	The temperature can drop to 0 °C (32 °F) which means foods could easily freeze.

Value	Description
B5	Default temperature
B9	Highest temperature

BioFresh B-Value

Choosing the setting

- ▶ Make your settings in the Customer menu (see 6.2 Operating logic) .



SuperCool

Select this function for the maximum cooling setting, to reach lower cooling temperatures.

This function is relevant to the fridge section *Fig. 1 (A)*

Use:

- Cool large amounts of food quickly.

Activating/deactivating settings

- ▶ Using the fridge section: activate the function when you add the goods.
- ▶ Activating/deactivating (see 6.2 Operating logic) .
- or-
- ▶ Activate/deactivate using the SmartDevice app.*

The function automatically turns off. The appliance goes back to normal mode. The temperature adjusts itself to the set level.



PartyMode

This option offers an assortment of special functions and settings that are useful if you are having a party.

The following functions are activated:

- *SuperCool*

You can set any functions you like. Your changes are lost when the option is switched off.

Activating/deactivating settings

- ▶ Activating/deactivating (see 6.2 Operating logic) .
- ▷ On: All functions are activated at the same time.
- ▷ Deactivated: Previously set temperatures are restored.

The function is automatically switched off after 24 hours.



HolidayMode

This function minimizes the energy consumption during an extended absence. The temperature of the refrigerator compartment is set to 15 °C (59 °F) and this is displayed on the status screen when the temperature has been reached.

Use:

- Save energy if you plan to be away for a while.
- Avoid coming home to bad smells and mold.

Activating/deactivating settings

- ▶ Empty everything from the fridge section.
- ▶ Activating/deactivating (see 6.2 Operating logic) .
- ▷ On: Fridge temperature is raised.
- ▷ Off: The previously set temperature is restored.



SabbathMode

With this function you can activate or deactivate the SabbathMode. If you activate this function, some electronic functions will be switched off. This allows your device to meet religious requirements on Jewish holidays such as the Sabbath and comply with STAR-K Kosher certification.

Appliance status with active SabbathMode
The status display continuously shows SabbathMode.
All functions in the display except the Deactivate SabbathMode function are locked.
Active functions remain active.
The display stays lit when you close the door.
The interior lighting is switched off.
Reminders are disabled. The set time intervals are paused.
Reminders and warnings are not displayed.
There is no door alarm.
There is no temperature alarm.
The defrost cycle only works for the specified time without taking account of appliance use.
After a power failure, the appliance returns to SabbathMode.

Appliance status

Note

This appliance has certification from the "Institute for Science and Halacha". (www.machonhalacha.co.il)

You can find a list of STAR-K-certified appliances at www.star-k.org/appliances.

Use

Activating SabbathMode



WARNING

Danger of poisoning from spoiled food!

If you have SabbathMode activated and a power failure occurs, no message appears in the status display about the power failure. Once the power is restored, the appliance continues to operate in SabbathMode. The power failure may mean that food spoils and the consumption of this food could lead to food poisoning. After a power failure:

▶ Do not consume food that has been frozen and thawed.

- ▶ Call up the settings menu. (see 6.2 Operating logic)
- ▶ Swipe left or right until the corresponding function is displayed.

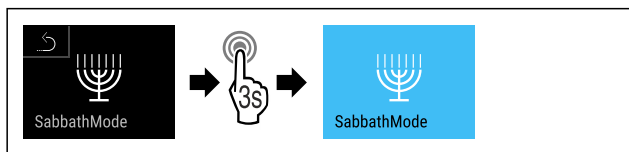

Fig. 13

- ▶ Complete the steps (see Fig. 136) .
- ▷ SabbathMode is activated.
- ▷ Status display continuously shows SabbathMode.

Deactivating SabbathMode

- ▶ Call up the settings menu. (see 6.2 Operating logic)
- ▶ Swipe left or right until the corresponding function is displayed.

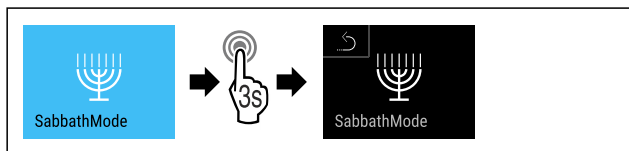

Fig. 14

- ▶ Complete the steps (see Fig. 137) .
- ▷ SabbathMode is deactivated.



EnergySaver

This function activates or deactivates the energy-saving mode. When you activate this function, the energy consumption decreases and the temperature increases by 2 °C (36 °F) in the appliance. The food remains fresh, but the shelf life is shortened.

Temperature zone	Recommended setting	Temperature when EnergySaver activated
5 °C Fridge compartment	5 °C 41 °F	7 °C 45 °F

Temperatures

Activating EnergySaver

- ▶ Swipe left or right until corresponding function is displayed.

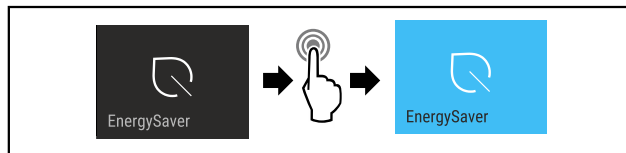

Fig. 15

- ▶ Complete the steps (see Fig. 138) .
- ▷ Energy-saving mode is activated.

Deactivating EnergySaver

- ▶ Swipe left or right until corresponding function is displayed.

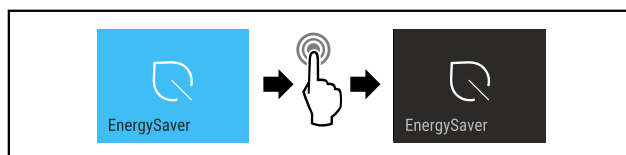

Fig. 16

- ▶ Complete the steps (see Fig. 139) .
- ▷ Energy-saving mode is deactivated.



CleaningMode

This setting makes it easy to clean the appliance. This setting is relevant to the fridge section Fig. 1 (A).

Use:

- Clean the fridge section manually.

What happens with the appliance when this setting is on:

- The display shows CleaningMode permanently.
- The refrigerator compartment is switched off.
- The internal light is on.
- Reminders and warnings are not shown. There is no acoustic signal.

Activating/deactivating settings

- ▶ Activate/deactivate setting (see 6.2 Operating logic) .
- ▷ On: Fridge compartment is switched off. Light stays on.
- ▷ Off: preset temperature is restored.

The setting is automatically deactivated after 60 minutes. Then the appliance continues operation in normal mode.



Display brightness

With this setting, you can choose a brightness level for the display.

You can set the following brightness levels:

- 40%

- 60%
- 80%
- 100%

Choosing the setting

- ▶ Set the level (see 6.2 Operating logic) .



Door alarm

Set the time before the door alarm (see Close the door) sounds.

Options are as follows:

- 1 min
- 2 min
- 3 min
- Off

Choosing the setting

- ▶ Set the level (see 6.4 Error messages) .



Entry lock

This setting avoids accidental operation of the appliance, e.g. by children.

Use:

- Avoid unintentional changing of settings and functions.
- Avoid unintentional switching off of the appliance.
- Avoid unintentional temperature adjustments.

Activating/deactivating settings

- ▶ Activating/deactivating (see 6.2 Operating logic) .



Language

This setting lets you choose the language of the display.

Choose from the following languages:

- German
- English
- French
- Spanish
- Italian
- Dutch
- Czech
- Polish
- Portuguese
- Russian
- Chinese

Activating/deactivating settings

- ▶ Activating/deactivating (see 6.2 Operating logic) .



Info

This setting allows the appliance information to be read out as well as access to the customer menu.

It provides the following information:

- Model name
- Index
- Serial number
- Service number

View appliance data

- ▶ Swipe in the display until Settings  appears.
- ▶ Confirm the display.
- ▶ Swipe in the display until About appears.
- ▶ Read the appliance data.



Reminder

Reminders are displayed acoustically by a beep and visually by a symbol in the display. The signal gets louder until the alert stops.



Replace the FreshAir active carbon filter

This message appears when the air filter needs replacing.

- ▶ Replace the air filter every six months.
- ▶ Confirm the message with OK.
- ▷ The service interval resets.
- ▷ The air filter guarantees the air quality in the fridge.

Activate setting

- ▶ Activating/deactivating (see 6.2 Operating logic) .



Reset

This function resets all settings to the factory settings. All settings that you have made thus far will be reset to their original values.

Activate the setting

- ▶ Activating (see 6.2 Operating logic) .

6.4 Error messages

Error messages appear in the display. There are two categories of error message:

Category	Meaning
Message	Reminder of general procedures. You can carry out these procedures to eliminate the message.

Equipment

Category	Meaning
Warning	Appears when there are malfunctions. A signal sounds in addition to the display. The signal becomes louder until you acknowledge by tapping the display. You can eliminate simple defects yourself. For more serious defects, you must contact customer service.

6.4.1 Warnings



Close the door

This message appears if the door is open too long. You can set the time before this message appears.

- ▶ Stop alarm: Confirm the message.

-or-

- ▶ Close the door.



Error

This message appears when there is a fault with the appliance. An appliance component has an error.

- ▶ Open the door.
- ▶ Take note of the error code.
- ▶ Confirm the message.
- ▷ The signal tone stops.
- ▷ The status display appears.
- ▶ Close the door.
- ▶ Contact customer service. (see 9.4 Customer service)

6.4.2 DemoMode

If “D” appears in the display, demo mode is on. This feature is designed for retailers. The cooling features are disabled.

Switching off DemoMode

When you see a time counting down:

- ▶ Confirm within the countdown.
- ▷ DemoMode is off.

If there is no countdown:

- ▶ Disconnect the power plug.
- ▶ Reconnect the power plug.
- ▷ DemoMode is off.

7 Equipment

7.1 Variable bottle shelf

7.1.1 Using the bottle shelf

Use the variable bottle shelf or the glass panel placed on the fridge floor.

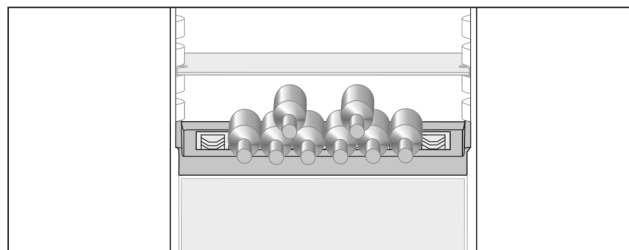

Fig. 17

- ▶ Remove the glass shelf and store separately.
- ▶ Place the bottles with the base pointing backwards facing the rear wall

Note

If the bottles protrude over the front of the bottle shelf:

- ▶ Move the bottom door rack higher up.

7.1.2 Removing the bottle shelf

You can remove the bottle shelf for cleaning.

- ▶ Remove the glass panel above the bottle shelf.

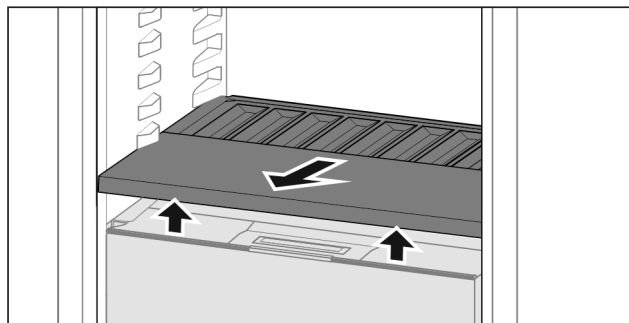

Fig. 18

- ▶ Lift the bottle shelf at the front and pull out.

Note

Liebherr recommends the following:

Do not place any goods on the drawer cover below.

7.1.3 Inserting the bottle shelf

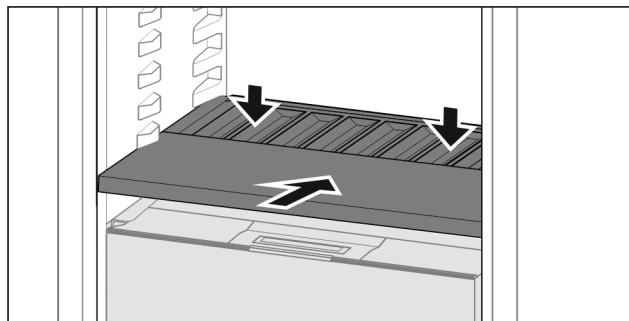

Fig. 19

- ▶ Slide in the bottle shelf until it engages and push down.
- ▷ The lugs at the back of the bottle shelf are connected automatically.
- ▷ LED lights up.

7.2 Drawers

You can remove the drawers for cleaning.

The way to remove/insert the drawers varies depending on the pull-out system. Your appliance can contain a variety of pull-out systems.

Note

Insufficient ventilation results in an increase in energy consumption and reduction of the refrigerating performance.

▶ Never obstruct the vents on the interior rear wall!

7.2.1 Drawer on telescopic rails

The drawer runs on full-extension rails (telescopic rails). There are full-extension telescopic rails and telescopic rails with partial pull-out. Drawers which are full extension can be pulled out fully from the appliance. Drawers with partial pull-out cannot be pulled out fully from the appliance. The system in your appliance depends on the type of appliance.

Full extension*

If you have full-extension rails, there is a clamp located at the back on the left and right of the rail.

Removing drawer

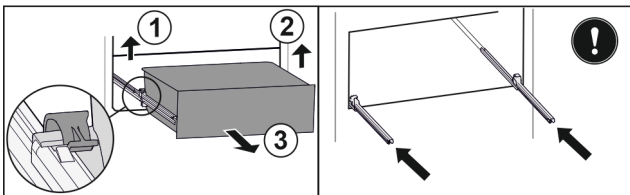

Fig. 20

- ▶ Pull out drawer as far as it will go.
- ▶ Lift left clamp and simultaneously pull drawer forwards on the left. Fig. 20 (1)
- ▶ Lift right clamp and simultaneously pull drawer forwards on the right. Fig. 20 (2)
- ▶ Remove drawer to the front. Fig. 20 (3)
- ▶ Slide rails in.

Inserting drawer

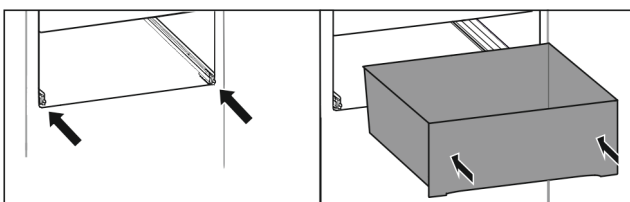

Fig. 21

- ▶ Slide rails in.
- ▶ Place drawer on rails.
- ▶ Slide in drawer to the back.
- ▷ Drawer latches in audibly at the back.

Full-extension glass drawer*

Removing drawer

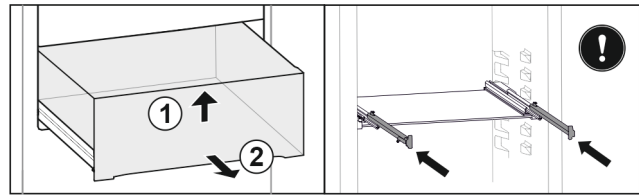

Fig. 22

- ▶ Pull out drawer as far as it will go.
- ▶ Lift up drawer at the front. Fig. 22 (1)
- ▶ Remove drawer to the front. Fig. 22 (2)
- ▶ Slide rails in.

Inserting drawer

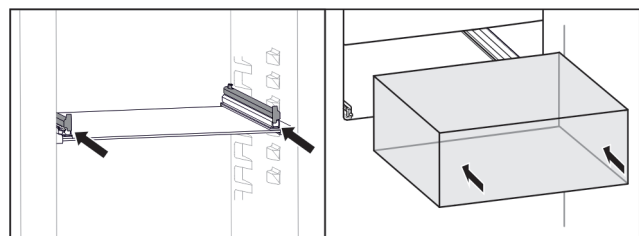

Fig. 23

- ▶ Slide rails in.
- ▶ Place drawer on rails.
- ▶ Slide in drawer to the back.
- ▷ Drawer latches in.

7.3 Fruit & Vegetable-Safe cover

The compartment lid can be removed for cleaning.

7.3.1 Removing the compartment lid

Make sure that the following requirements are fulfilled

- Bottle shelf is removed (see 7.1 Variable bottle shelf).

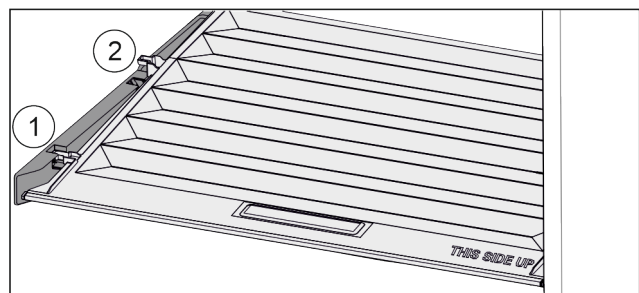

Fig. 24

- If the drawers are removed:
- ▶ Pull the lid up at the front in the retaining parts to the opening Fig. 24 (1).
- ▶ Lift from the back and pull it up and out Fig. 24 (2).

Equipment

7.3.2 Inserting the compartment lid

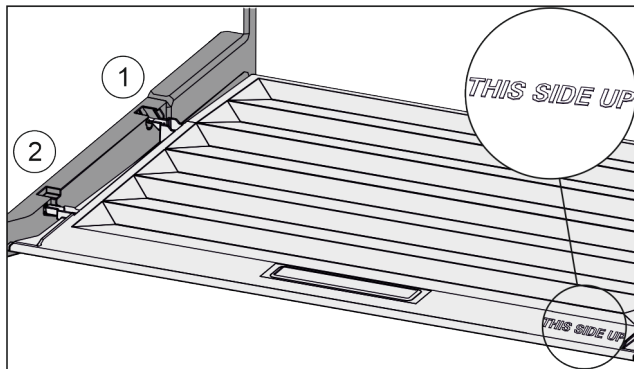

Fig. 25

If the text THIS SIDE UP is on top:

- ▶ Insert the lip of the cover over the opening of the rear bracket Fig. 25 (1) and click into place Fig. 25 (2).
- ▶ Position the cover where you want it (see 7.4 Humidity control).

7.4 Humidity control

You can regulate the moisture in the drawer yourself by adjusting the compartment cover.

The compartment cover is on the drawer itself and can be covered with shelves or additional drawers.

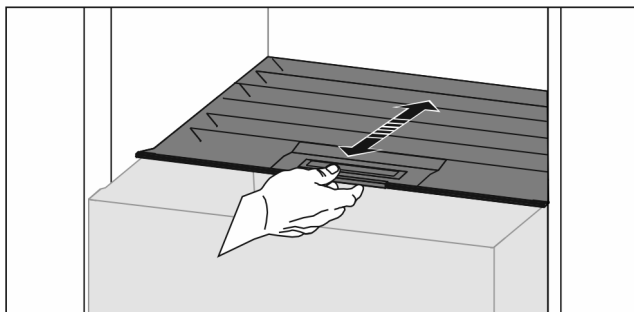

Fig. 26

Low air humidity

- ▶ Open the drawer.
- ▶ Pull the drawer cover to the front.
- ▷ If the drawer is closed: Gap between lid and compartment.
- ▷ Moisture levels lower in the Safe.

High air moisture:

- ▶ Open the drawer.
- ▶ Slide the compartment cover to the back.
- ▷ If the drawer is closed: The cover seals the compartment.
- ▷ Moisture levels rise in the Safe.

If there is too much moisture in the compartment:

- ▶ Choose a “low moisture setting”.

-or-

- ▶ Remove the moisture with a cloth.

Note

With the “low humidity” setting, the Fruit & Vegetable-Safe can also be used as a Meat & Dairy-Safe.

- ▶ Choose a “low moisture” setting.

7.5 Glass shelves

You can remove the glass shelf under the drawers for cleaning.

7.5.1 Removing / inserting the glass shelf

Make sure that the following requirements are fulfilled:

- ❑ Glass shelf under the drawer: Drawer has been removed. (see 7.2 Drawers)

Removing glass shelf

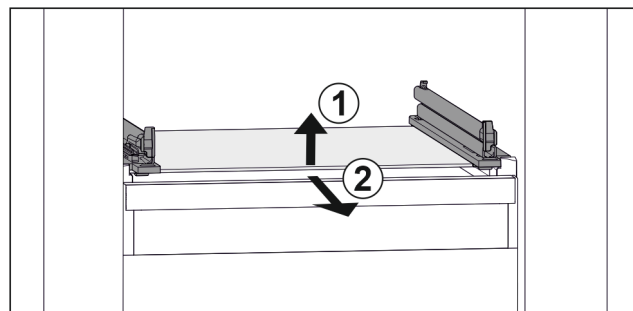

Fig. 27 Example illustration of glass shelf

- ▶ Lift glass shelf at the front. Fig. 27 (1)
- ▶ Remove glass shelf to the front. Fig. 27 (2)

Inserting the glass shelf

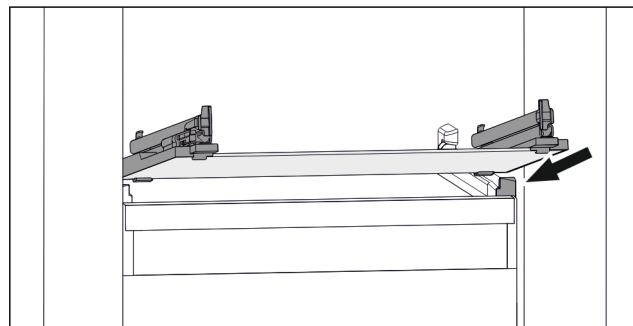

Fig. 28 Example illustration of glass shelf

- ▶ Position glass shelf at an angle behind the stoppers. (see Fig. 151)
- ▶ Lower glass shelf.
- ▶ Slide in glass shelf to the back.

7.6 Accessories

7.6.1 Bottle rack

Using the bottle rack

Store open bottles in the bottle rack.

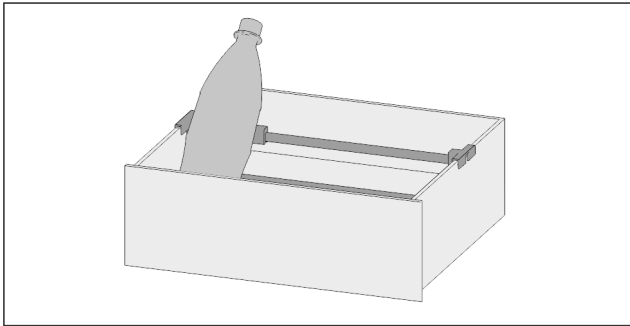

Fig. 29

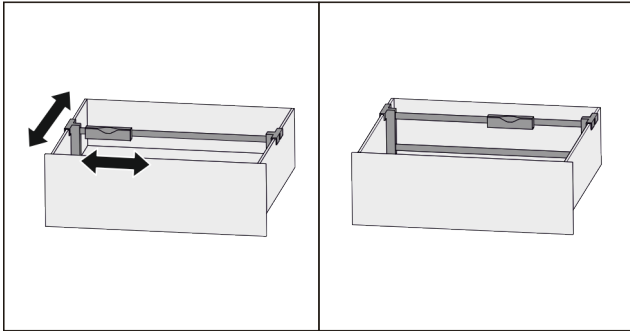

Fig. 30

- ▶ Place bottles in the slots of the bottle rack.
- ▷ Stops bottles from tipping over.

Removing the bottle rack

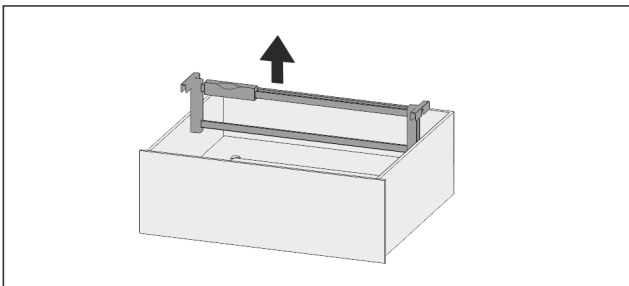

Fig. 31

- ▶ Lift the bottle rack up and out to remove.

7.6.2 FlexSystem

Using the FlexSystem

The FlexSystem helps you store and arrange food clearly and in the way you want. It lets you clearly divide your food into fruit, vegetables or by use-by dates, for example.

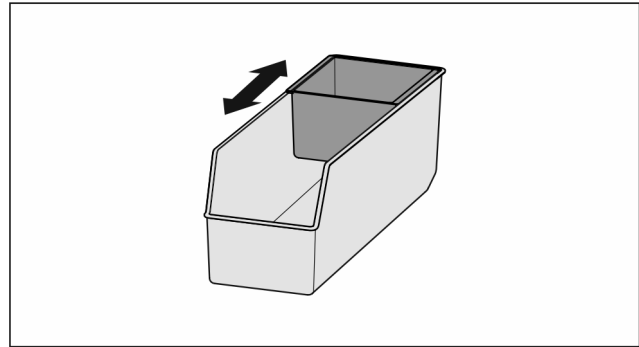

Fig. 32

- ▶ Move the inside tray.

Removing the FlexSystem

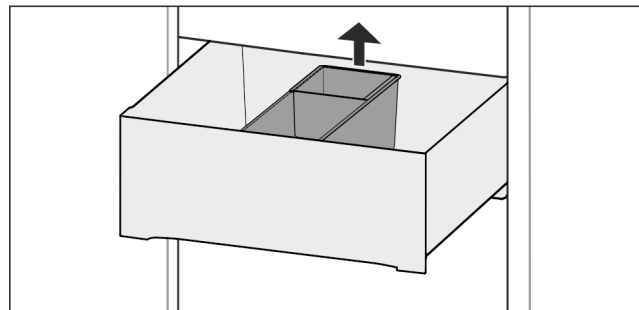

Fig. 33

- ▶ Lift the FlexSystem at the back.
- ▶ Pull up and out.

Inserting the FlexSystem

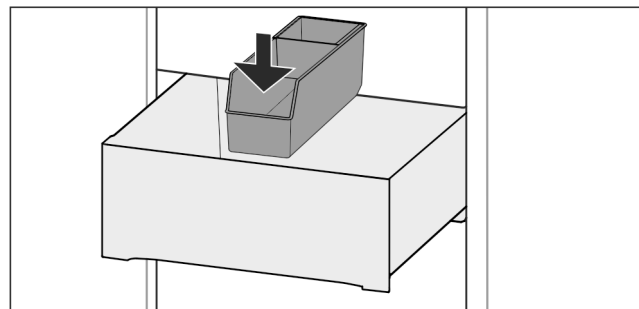
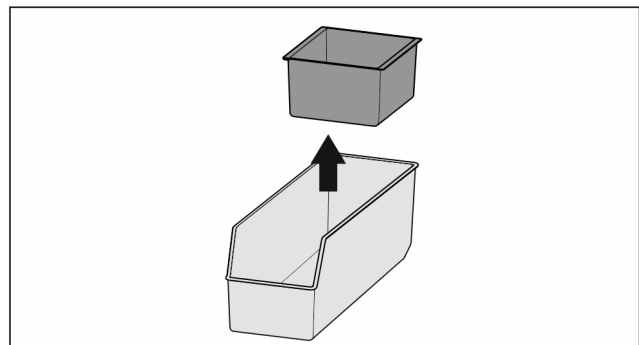

Fig. 34

- ▶ Insert front of the FlexSystem first.
- ▶ Lower the back part.

Disassembling the FlexSystem

The FlexSystem can be dismantled for cleaning.



Maintenance

Fig. 35

- Dismantling the FlexSystem.

8 Maintenance

8.1 FreshAir carbon filter

The FreshAir carbon filter is located in the compartment above the fan.

It guarantees the best air quality.

- Change the carbon filter every 6 months.
When the reminder is set, a message on the display prompts you to change it.
- You can dispose of the carbon filter with the regular household waste.

Note

FreshAir activated charcoal filters can be purchased from the Liebherr Service Center. The address for your respective country can be found on the back of the instructions.

8.1.1 Removing the FreshAir carbon filter

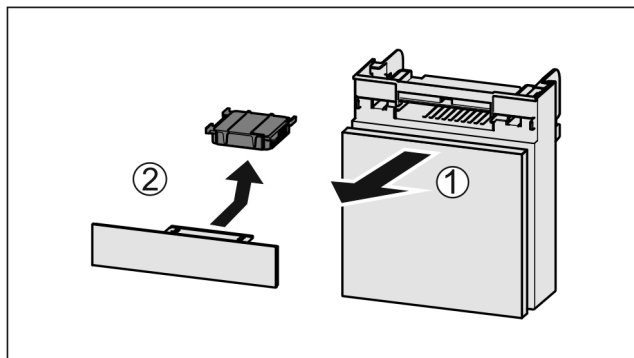

Fig. 36

- Pull out the compartment Fig. 36 (1).
- Remove the carbon filter Fig. 36 (2).

8.1.2 Inserting the FreshAir carbon filter

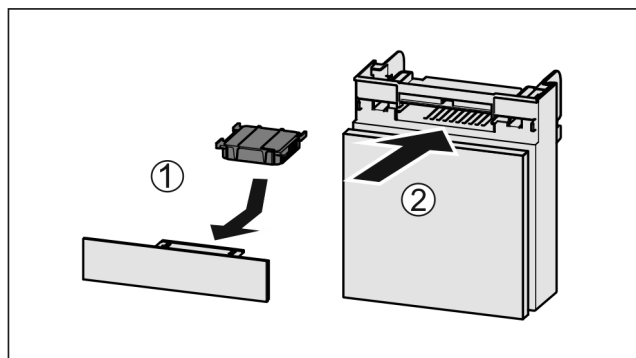

Fig. 37

- Insert the carbon filter as shown in the diagram Fig. 37 (1).
- ▷ The carbon filter clicks into place.
If the carbon filter is pointing downwards:

- Push the compartment in Fig. 37 (2).
- ▷ The carbon filter is now ready for use.

8.2 Disassembling / assembling pull-out systems

8.2.1 Notes on disassembly

You can disassemble some of the pull-out systems for cleaning. Your appliance can contain a variety of pull-out systems.

The following pull-out systems can be disassembled or cannot be disassembled:

Pull-out system	can be disassembled / cannot be disassembled
Full extension*	cannot be disassembled*
Full-extension glass drawer*	can be disassembled (see 8.2.2.1 Full-extension glass drawer*) *

8.2.2 Drawer on telescopic rails

Full-extension glass drawer*

Disassembling pull-out system

Make sure that the following requirements are fulfilled:

- Drawer has been removed. (see 7.2.1.2 Full-extension glass drawer*)
- Glass shelf has been removed. (see 7.5 Glass shelves)

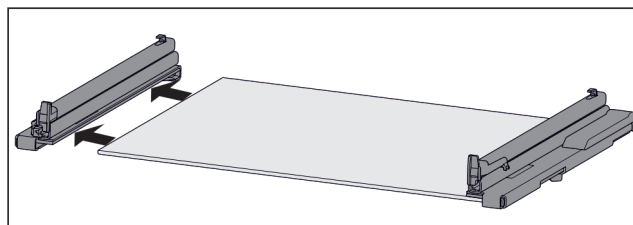

Fig. 38 Glass shelf with rails

- Remove rail from glass shelf sideways.

Installing pull-out system

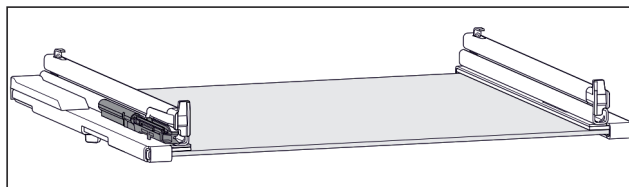

Fig. 39 Damping mechanism

The damping mechanism is attached to the left rail. (see Fig. 162) There is no damping mechanism attached to the right rail.

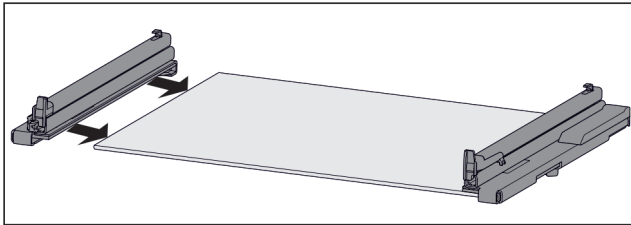

Fig. 40 Glass shelf with rails

Install rail **with** damping mechanism:

- ▶ Push rail as far as it will go onto the **left** side of the glass shelf.
- Install rail **without** damping mechanism:
- ▶ Push rail as far as it will go onto the **right** side of the glass shelf.

8.3 Defrosting the appliance



WARNING

Appliance incorrectly defrosted!
Injuries and damage.

- ▶ Do not use mechanical devices or other means to accelerate the defrosting process, other than those recommended by the manufacturer.
- ▶ Do not use any electrical heating or steam cleaning equipment, naked flames or defrosting sprays.
- ▶ Do not remove ice with sharp objects.

Defrosting is performed automatically. The water from the thawing process runs out via the drain opening and is evaporated.

Water droplets or a thin layer of frost or ice can form on the rear wall; this is a completely normal part of the appliance's function. You do not have to remove them.

- ▶ Clean the drain opening regularly (see 8.4 Cleaning the appliance).

8.4 Cleaning the appliance

8.4.1 Preparation



WARNING

Danger of electric shock.

- ▶ Unplug refrigerator or disconnect power.



WARNING

Danger of fire

- ▶ Do not damage the refrigerant circuit.

- ▶ Empty appliance.
- ▶ Pull out the power plug.

-or-

- ▶ Activate CleaningMode. (see CleaningMode)

8.4.2 Cleaning the interior

NOTICE

Improper cleaning!
Damage to the appliance.

- ▶ Only use soft cleaning cloths and ph-neutral all-purpose cleaners.
- ▶ Do not use steel wool or sponges that scour or scratch.
- ▶ Do not use caustic or abrasive cleaning materials or those containing sand, chloride, or acids.

- ▶ Plastic surfaces: clean by hand with a soft clean cloth, lukewarm water and a little detergent.
- ▶ Metal surfaces: clean by hand with a soft clean cloth, lukewarm water and a little detergent.
- ▶ Drain hole: remove any deposits with a thin item such as a cotton bud.

8.4.3 Cleaning the equipment

NOTICE

Improper cleaning!
Damage to the appliance.

- ▶ Only use soft cleaning cloths and ph-neutral all-purpose cleaners.
- ▶ Do not use steel wool or sponges that scour or scratch.
- ▶ Do not use caustic or abrasive cleaning materials or those containing sand, chloride, or acids.

Clean with a soft, clean cloth, lukewarm water and a little washing up liquid:

- Fruit & Vegetable-Safe cover
- Drawer
- Bottle rack
- Variable bottle shelf
- FlexSystem

Clean with a damp cloth:

- Retracting rails
Please note: the grease in the tracks is there for lubrication purposes and must not be removed!
- ▶ Disassemble the equipment: see the relevant section.
- ▶ Clean the equipment.

8.4.4 After cleaning

- ▶ Wipe dry the appliance and items of equipment
- ▶ Connect and switch on the appliance.
When the temperature is sufficiently cold
- ▶ Place the food inside.
- ▶ Repeat cleaning regularly.

Customer support

9 Customer support

9.1 Technical specifications

Temperature zone	
Cool:	3 °C (36 °F) to 9 °C (46 °F)
BioFresh	0 °C (32 °F) to 3 °C (37 °F)

Max. equipment capacity			
Equipment	Appliance width 550 mm (21 5/8 in) (see installation instructions, appliance dimensions)	Appliance width 600 mm (23 1/2 in) (see installation instructions, appliance dimensions)	Appliance width 700 mm (27 9/16 in) (see installation instructions, appliance dimensions)
Glass drawer, height 59 mm (2 5/16 in)	15 kg (33.07 lb)	--	--
Glass drawer, height 100 mm (3 15/16 in)	15 kg (33.07 lb)	--	--
Glass drawer, height 150 mm (5 5/16 in)	20 kg (44.09 lb)	--	--

For appliances with a WiFi connection:*

Frequency specification*	
Frequency band	2.4 GHz
Maximum radiated power	< 100 mW
Purpose of the wireless equipment	Integration in the local WiFi network for data communication

9.2 Operating noises

The appliance makes noises while in operation.

- At **less cooling output** the appliance saves energy but takes longer to cool items. The volume is **lower**.
- At **a higher cooling output** the food cools more quickly. The volume is **higher**.

Examples:

- Activated functions (see 6.3 Functions)
- Running fan
- Freshly sorted food
- High ambient temperature
- Door opened for long periods

Noise	Possible cause	Type of noise
Bubbling and splashing	Coolant is flowing into the cooling circuit.	Normal noise
Spitting and hissing	Coolant is spraying into the cooling circuit.	Normal noise
Humming	The appliance cools. The volume depends on the cooling output.	Normal noise
Sipping noises	The self-closing door is being opened and closed.	Normal noise
Whirring and murmuring	The fan is running.	Normal operating noise
Clicking	Components are being switched on and off.	Normal switching noise
Rattling or humming	Valves are active.	Normal switching noise

Noise	Possible cause	Type of noise	How to resolve
Vibration	Unsuitable installation	Error noise	Check installation. Set up the appliance.
Clattering	Equipment, Objects inside the appliance	Error noise	Secure equipment parts. Leave a gap between items.

9.3 Technical faults

Your appliance is designed and manufactured for reliable operation and a long service life. If a malfunction nonetheless occurs during operation, please check whether the malfunction is due to an operating error. In this case, you will have to be charged for the costs incurred, even during the warranty period.

You may be able to rectify the following faults yourself. **9.3.1 Appliance function**

Defect	Cause	Remedy
The appliance does not work.	The appliance is not switched on.	▶ Switch on the appliance.
	The power plug is not properly inserted in the wall socket.	▶ Check the power plug.
	The powerfuse in the wall socket is not OK.	▶ Check the fuse.
	Power failure.	▶ Keep the appliance closed. ▶ Protect your food: Lay freezer packs on top of the food or use another freezer if the power is off for a prolonged period. ▶ Do not re-freeze defrosted food.
	The appliance connector is not correctly inserted in the appliance.	▶ Check the appliance connector.
The temperature is not cold enough	This means that the door of the appliance is not closed properly	▶ Close the appliance door
	Insufficient ventilation	▶ Clear and clean the ventilation grille.
	The ambient temperature is too high	▶ Solution: (see 1.5 Range of appliance use) .
	The appliance was opened too frequently or for too long	▶ Wait to see whether the required temperature resets itself by itself. If not, contact Customer Service (see 9.4 Customer service) .
	The temperature is incorrectly set	▶ Set to a colder temperature and check after 24 hours.
	The appliance is too near to a heat source (stove, heater etc).	▶ Change location of appliance or the heat source.
	The appliance was not properly installed in the recess.	▶ Make sure the appliance was installed correctly and the door closes properly.
The door seal is defective or should be replaced for other reasons.	The door seal is interchangeable. You can replace it without the use of any special tools.	▶ Contact Customer Service (see 9.4 Customer service) .
The appliance is iced up or condensation is building.	The door seal may have slipped out of its groove.	▶ Check the door seal is well placed in the groove.

9.3.2 Equipment

Defect	Cause	Remedy
The interior light does not turn on.	The appliance is not switched on.	▶ Switch on the appliance.
	The door was open for longer than 15 min.	▶ The interior light automatically switches itself off if the door stays open for approx. 15 min.

Decommissioning

Defect	Cause	Remedy
	The LED interior light is faulty or the lid is damaged.	▶ Contact Customer Service (see 9.4 Customer service).

9.4 Customer service

First check if you can fix the error yourself (see 9 Customer support) . If this is not the case, please contact customer service.

Please refer to the enclosed “Liebherr Service” brochure for the address.



WARNING

Unprofessional repair!
Injuries.

- ▶ A damaged power cable may only be replaced by the manufacturer, the manufacturer’s Customer Service or a similarly qualified person.
- ▶ For appliances with plug and play connection cables, the change can be made by the customer.

9.4.1 Contact Customer Service

Make sure to have the following appliance information to hand:

- Appliance name (model and index)
- Service no. (service)
- Serial no. (S no.)
- ▶ Showing appliance info on the display (see Info) .
- or-
- ▶ Referring to appliance info on the nameplate (see 9.5 Rating plate) .
- ▶ Take note of the appliance information.
- ▶ Inform Customer Service: Tell us the problem and the appliance details.
- ▷ This will help us give you fast and accurate support.
- ▶ Further instructions from customer service will follow.

9.5 Rating plate

The nameplate is located behind the drawers on the inside of the appliance.

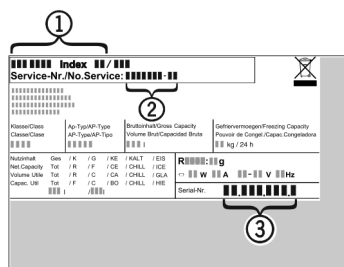

Fig. 41

- (1) Appliance name
- (2) Service no.
- (3) Serial no.

- ▶ Information from the nameplate.

10 Decommissioning

- ▶ Empty appliance.
- ▶ Switch off the appliance .
- ▶ Pull out the power plug.
- ▶ Remove the appliance connector if necessary: Pull it out and, at the same time, move it from the left to the right.
- ▶ Clean the appliance (see 8.4 Cleaning the appliance) .
- ▶ Leave the door open to prevent bad smells

11 Disposal

11.1 Preparing the appliance for disposal



WARNING

Risk of child entrapment!

- Before you throw away your old refrigerator or freezer:
- ▶ Take off the doors.
 - ▶ Leave the shelves in place so that children may not easily climb inside.



Li-Ion

Liebherr uses batteries in some of its appliances. You should remove these before disposal of the old appliance for environmental reasons. If your appliance contains batteries, a corresponding notice is attached to the appliance.

Lamps If you can remove the lamps yourself without destroying them, also remove these before disposal.

- ▶ Take the appliance out of operation.
- ▶ Appliance with batteries: Remove the batteries. For description, see **Maintenance** chapter.
- ▶ If possible: Remove lamps without destroying them.

11.2 Disposing of the appliance in an environmentally friendly manner



The appliance still contains valuable materials and must be collected separately from unsorted municipal waste so it can be recycled.



Li-Ion



Li-Ion

Dispose of batteries separately from the old appliance. Certain batteries should NOT go in household garbage or recycling bins. Waste batteries can always be recycled or taken to household hazardous waste collection points. To prevent fires from lithium-ion batteries, tape battery terminals and/or place batteries in separate plastic bags and never put these batteries in household garbage or recycling bins.

Lamps

Dispose of removed lamps via the respective collection systems.

For USA:

Check the Responsible Appliance Disposal (RAD) program to find a RAD partner near you.

For Canada:

Follow your local guidance about recycling and disposal capabilities near you.



WARNING

Leaking refrigerant and oil!

Fire. The refrigerant contained within the appliance is environmentally friendly, but flammable. The oil contained within the appliance is flammable. Escaping refrigerant and oil can ignite if they are of high enough concentration and are exposed to an external heat source.

- ▶ Do not damage the pipelines of the coolant circuit and the compressor.
- ▶ Transport the appliance away without damaging it.
- ▶ Dispose of batteries, lamps, and the appliance according to the above specifications.



home.liebherr.com/fridge-manuals

EN Built-in refrigerator with BioFresh

Issue date: 20230512

Part number index: 7088385-00

For Service in the U.S.: Liebherr Service Center
Toll Free: 1-866-LIEBHER or 1-866-543-2437
Service-appliances.us@liebherr.com
PlusOne Solutions, Inc.
3501 Quadrangle Blvd, Suite 120
Orlando, FL 32817

For Service in Canada: Liebherr Service Center
Toll Free: 1-888-LIEBHER or 1-888-543-2437
www.euro-parts.ca
EURO-PARTS CANADA
39822 Belgrave Road, Belgrave, Ontario, N0G 1E0
Phone: (519) 357-3320 | Fax: (519) 357-1326