

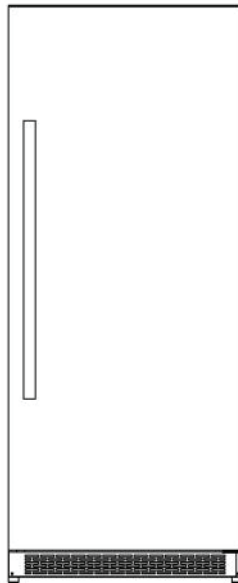

Intertek
5014043

CONFORMS TO UL STD.60335-1 & 60335-2-24
CERTIFIED TO CSA STD.C22.2 NO.60335-1 & 60335-2-24

BUILT-IN OR FREESTANDING REFRIGERATOR
INSTRUCTION MANUAL



Model No.: FFRBI1821-30S

IMPORTANT:
READ AND SAVE THESE INSTRUCTIONS

NOTICE:
Installer: Leave this guide with the homeowner
Homeowner: Keep this guide for future reference

INDEX

CUSTOMER CARE

IMPORTANT SAFETY INSTRUCTIONS

INSTALLATION INSTRUCTIONS

BEFORE USING YOUR REFRIGERATOR

SITE PREPARATION

ANTI-TIP BRACKET INSTALLATION

INSTALLING YOUR REFRIGERATOR

ELECTRICAL CONNECTION

ABOUT YOUR REFRIGERATOR

LEVELING THE UNIT

INSTALLING THE HANDLE

OPERATING YOUR REFRIGERATOR

TEMPERATURE CONTROL

AUTOMATIC DEFROST

CHANGING THE REVERSIBLE DOOR

CARE AND MAINTENANCE

CLEANING YOUR APPLIANCE

VACATION TIME

MOVING YOUR APPLIANCE

ENERGY SAVING TIPS

TROUBLESHOOTING GUIDE

WARNING

WIRE DIAGRAM

CUSTOMER CARE

Thank you for purchasing a FORNO product. Please read the entire instruction manual before operating your new appliance for the first time. Whether you are an occasional user or an expert, it will be beneficial to familiarize yourself with the safety practices, features, operation and care recommendations of your cooking range.

The model and serial number are listed inside the product. For warranty purposes, you will also need the date of purchase.

Record this information below for future reference.

SERVICE INFORMATION

Model Number:

Use these numbers in any correspondence or service calls concerning your cooking range.

Serial Number:

If you received a damaged appliance, immediately contact the dealer (or builder) that sold you the product.

Date of Purchase:

Purchase Address & Phone:

Save time and money. Before you call for service, check the Troubleshooting Guide. It lists the causes of minor operating problems that you can correct yourself.

SERVICE IN CANADA:

Keep the instruction manual handy to answer your questions. If you don't understand something or you need more assistance, please call our Customer Service: 1-800-561-7265

Or email: service@distinctive-online.com

Or contact: CTM Household Appliances Inc

11420 Albert Hudon, Montreal, Quebec, H1G 3J6, Canada

SERVICE IN THE UNITED STATES:

Keep the instruction manual handy to answer your questions. If you don't understand something or you need more assistance, please call our Customer Service: 1-866-231-8893

Or email: info@forno.ca

If your product ever requires servicing, be sure to use a **FORNO** Factory Certified Service provider recommended by our customer care center. All Factory Certified Service providers are carefully selected and thoroughly trained by us.



To ensure proper use of this refrigerator and your safety, please read the following instructions completely before operating this appliance.

IMPORTANT SAFETY INSTRUCTIONS



WARNING

To reduce the risk of fire, electrical shock, or injury when using your appliance, follow these basic precautions:

 **DANGER** : Risk of child entrapment.

- Child entrapment and suffocation are not problems of the past. Junked or abandoned appliances are still dangerous, even if they will “just sit for a few days”.
- To avoid the possibility of child entrapment, please take the following precautions before discarding your old refrigerator.
 - Take off the doors.
 - Leave the shelves in place so that children may not easily climb inside.
- Never allow children to operate, play with, or crawl inside the refrigerator.
- **Refrigerants:** All refrigeration products contain refrigerants, which under the guidelines of federal law must be removed before disposal of product. It is the consumer’s responsibility to comply with federal and local regulations when disposing of this product.
- Never clean refrigerator parts with flammable fluids. The fumes can create a fire hazard or explosion.
- Do not store or use gasoline or any other flammable vapors and liquids in the vicinity of this or any other appliance. The fumes can create a fire hazard or an explosion.

FOLLOW WARNING CALLOUTS BELOW ONLY WHEN APPLICABLE TO YOUR MODEL.

Use two or more people to move and install appliance. Failure to do so can result in back or other injury.

To ensure proper ventilation for your appliance, the front of the unit must be completely unobstructed.

Choose a well-ventilated area with temperature above 50°F(10°C) and below 109.4 °F(43°C).

The appliance should not be located next to ovens, grills or other sources of high heat.

The appliance must be installed with all electrical, water and drain connections in accordance with state and local codes. A standard electrical supply (115VAC only, 60Hz) properly grounded in accordance with the National Electrical Code and local codes and ordinances, is required.

Do not kink or pinch the power supply cord of the appliance.

The size of the fuse (or circuit breaker) should be 1.3A.

It is important that the appliance be leveled in order to work properly. You may need to make several adjustment to level it.

All installations must be in accordance with local plumbing code requirements.

Make certain that the pipes are not pinched, kinked or damaged during installation.

Check for leaks after connection.

Never allow children to operate, play with or crawl inside the appliance.

Do not use solvent-based cleaning agents or abrasives on the interior. These cleaners may damage or discolor the interior.

Use this appliance only for its intended purpose as described in this instruction manual.

Keep fingers out of the “pinch point” areas, Clearances between the door and cabinet are necessarily small. Be careful closing door when children are in the area.

-Save these instructions-

This appliance is not intended for use by persons (including children) with reduced physical, sensory or mental capabilities, or lack of experience and knowledge, unless they have been given supervision or instruction concerning use of the appliance by person responsible for their

safety.

INSTALLATION INSTRUCTIONS

Before Using Your Refrigerator

- Remove the exterior and interior packing.
- Leave the refrigerator in an upright position for at least 4-6 hours before you connect it to the mains. This will reduce the possibility of a malfunction in the cooling system from improper handling during transportation.
- Clean the interior surface with lukewarm water using a soft cloth. (Refer to Cleaning instruction section)
- Install the handles on the drawers. (Refer to Installing The Handle section)
- It is recommended that you install the unit in a place where the ambient temperature is between 50°F(10°C) and 109.4°F(43°C). If the ambient temperature is above or below recommended temperatures, the performance of the unit may be affected. For example, placing your unit in extremely cold or hot conditions may cause interior temperatures to fluctuate. The operating temperature range may not be reached.

Check to make sure you have all the parts in accessory list.

Site Preparation

1. Position the unit on a flat, level surface capable of supporting the entire weight of the unit. The unit will be significantly heavier once it is fully loaded.
2. Avoid connecting the unit to a Ground Fault Interrupter(GFI). GFI are prone to nuisance tripping which will cause the unit to shut down. GFIs are generally not used on circuits which power equipment that must run unattended for long periods of time.
3. The unit must be installed according to your local codes and ordinances.
4. Position the unit to allow free air flow through the ventilation grill at the bottom in the front.

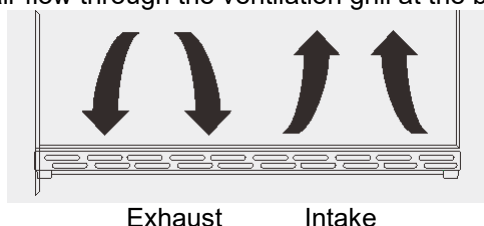

5. Wipe out inside of unit with a damp cloth.
6. Be sure to install the Anti-Tip bracket. Follow the instructions provided with the Anti-Tip bracket kit.



The Anti-Tip kit must be installed on this unit before it is used. Double stacking units may cause serious personal injury.

Anti-Tip Bracket Installation

⚡WARNING⚡ To avoid the risk of serious personal injury or damage to the appliance due to the instability of the appliance, it must be fixed to the floor with anti-tip brackets and screws (supplied). Before installing, carefully read these instructions.

- A. Take the fixing brackets (2pcs) and screws (2pcs) out of the instruction packet.
- B. Drill holes into the floor according to the dimensions shown below. This will allow you to fix the brackets to the floor.

According to size and location, the hole punched on the floor should be Ø5/16".

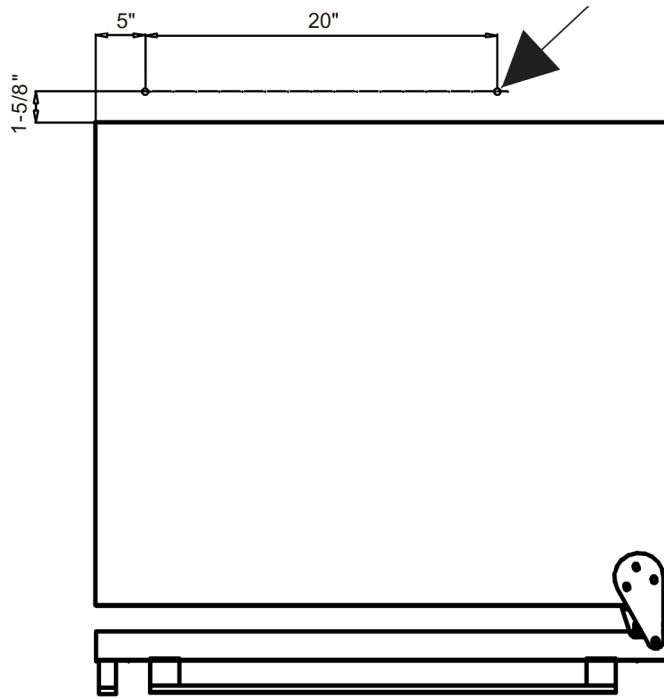

Use two expansion screws to fix feet on the floor

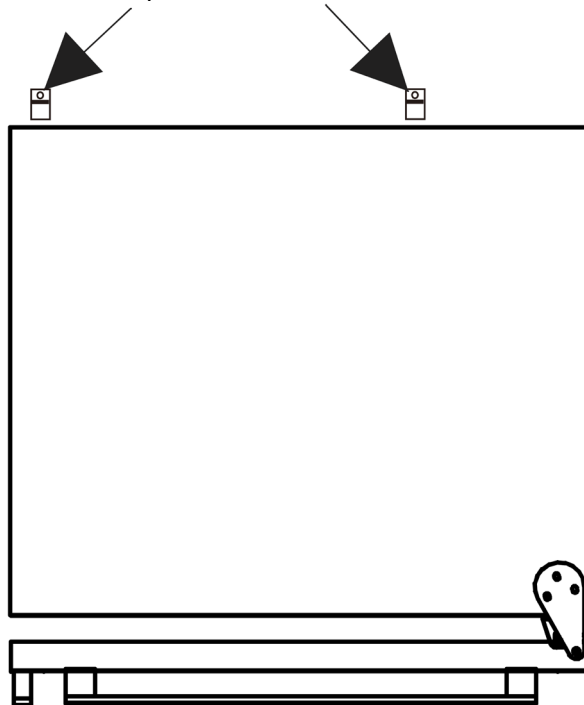

C. Push the appliance into its place of installation.

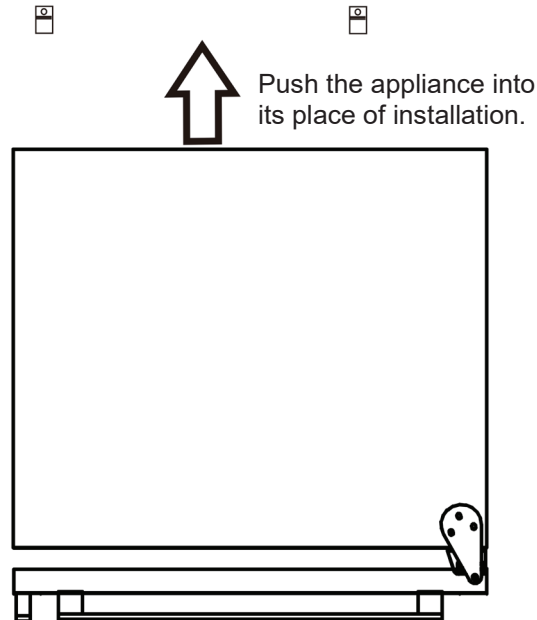

D. If the unit is not stable, pull out the appliance and repeat the previous step until the unit is stable.

Note: If the unit is relocated, the bracket must be removed and installed in the new location.

Installing Your Refrigerator

- Allow a minimum of 2 inches at the back, 0.8 inches at each sides and 3.5 inches on top to for proper air ventilation. Adjust the feet to keep the refrigerator level.
- Locate the refrigerator away from direct sunlight and sources of heat (stove, heater, radiator, etc.). Direct sunlight may affect the acrylic coating and heat sources may increase electrical consumption. Ambient temperature below 50°F (10°C) or above 85°F (29°C) will hinder the performance of this appliance. **This unit is not designed for use in a garage or any other outside installation.**
- Avoid locating the refrigerator in moist areas.
- Plug the refrigerator into dedicated, properly installed-grounded wall outlet. Do not under any circumstances cut or remove the third (ground) prong from the power cord. Any questions concerning power and/or grounding should be directed toward a certified electrician or an authorized service center. **This unit is not designed to be installed in an RV or used with an inverter.**
- After plugging the refrigerator into a wall outlet, turn the unit on and allow the unit to cool down for 3 ~ 4 hours under before placing food in the appliance.

This appliance is intended to be used in household and similar applications such as staff kitchen areas in shops, offices and other working environments; farm houses and by clients in hotels, motels and other residential type environments; bed and breakfast type environments; catering and similar non-retail applications.

Electrical Connection

⚡WARNING⚡

Improper use of the grounded plug can result in the risk of electrical shock. If the power cord is damaged, it must be replaced the manufacturer, its services agent or similarly qualified persons in order to avoid a hazard.

This refrigerator should be properly grounded for your safety. The power cord of this refrigerator is equipped with a three-prong plug which mates with standard three prong wall outlets to minimize the

possibility of electrical shock.

Do not, under any circumstances, cut or remove the third ground prong from the power cord supplied.

This refrigerator requires a standard 115 Volt A.C. /60Hz electrical outlet with three-prong ground.

This refrigerator is not designed to be used with an inverter.

The cord should be secured behind the refrigerator and not left exposed or dangling to prevent accidental injury.

Never unplug the refrigerator by pulling the power cord. Always grip the plug firmly and pull straight out from the receptacle.

Do not use an extension cord with this appliance. If the refrigerator is too short, have a qualified electrician or service technician install an outlet near the appliance. Use of an extension cord can negatively affect the performance of the unit.

If any problems with the refrigerator persist, please contact our Customer Service Dept.

ABOUT YOUR REFRIGERATOR

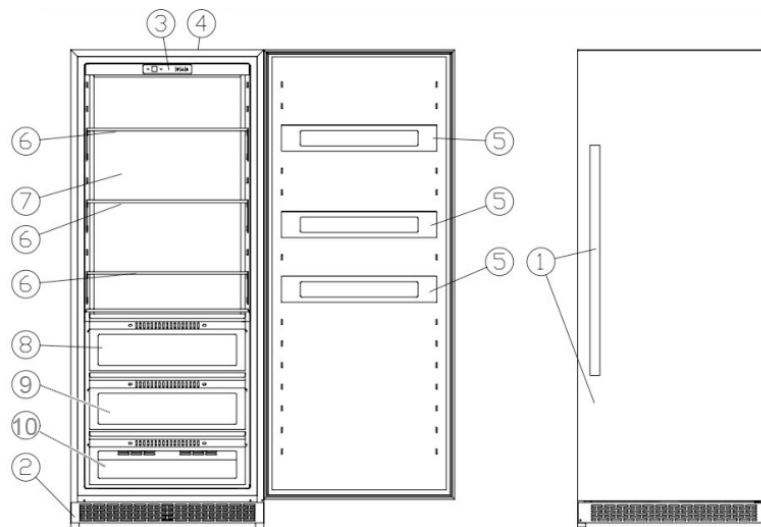

1)Stainless steel door and handle	2)Ventilation grill
3)Control panel	4)Cabinet
5)Door basket	6)Adjustable glass shelves
7)Internal LED light	8)Upper drawer
9)Middle drawer	10)Lower drawer

Product Description	Built-in Refrigerator		
	Width	Height	Depth
Unit Dimensions			

(inches)	29.5"	73.6"	30.1"(with handle)
Net Weight (lbs)	350 lbs		

Leveling The Unit

Position the unit on a flat, level surface capable of supporting the entire weight of the unit when full. This unit contains four (4) adjustable leveling legs. Turn the legs clockwise to raise and counterclockwise to lower.

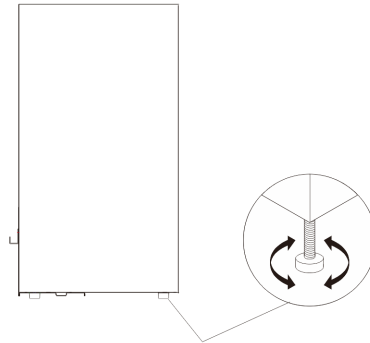

Turn to adjust the feet

Installing The Handle

1. Locate the handle over the pins on the door.
2. Fix the handle by tighten the screw.

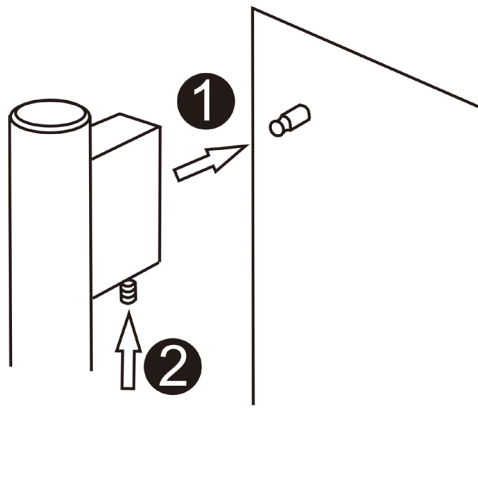









OPERATING YOUR REFRIGERATOR



Temperature Control



ON/OFF Power  POWER

To turn the unit ON or OFF, press and hold the key for 3 seconds.

	<p>Press this key to select the temperature display setting in Fahrenheit or Celsius degrees. To change the temperature from Fahrenheit to Celsius or from Celsius to Fahrenheit.</p>
<p>Temperature set key </p>	<p>Press to activate the temperature setting mode.</p>
<p>Up  and Down </p>	<p>Press  to enter temperature setting mode, then press  or  to increase or decrease the set temperature by 1°C (or 1°F). Press  to confirm the setting and shows the actual temperature. If no further operation in 6 seconds, display will show actual temperature in the cooler.</p>

The temperature you are setting will increase by one degree each time you press the  key, and will decrease by one degree each time you press the  key.

The range of temperature control is from 0°C(32°F) to 10°C(50°F).

To view the set temperature at any time, press the  key. The set temperature will flash in the display window for 6 seconds, the temperature inside the unit will reappear in the display window.

Interior Light

The unit is equipped with an interior LED light which will be turned ON when the door is opened.

Defrosting

The unit defrosts automatically in normal operating conditions.

The evaporator under the bottom of the unit defrosts automatically.

Drainage channel behind the rear wall of the unit, and flows through the drainage hole into the drip tray by the compressor where it evaporates.

However, frost may accumulate on the evaporator if the unit is repeatedly opened in high heat or high humidity location. If this frost pattern does not clear within 24 hours, your unit will require manual defrosting.

WARNING: If the unit is unplugged or loses power; you must wait 3 to 5 minutes before restarting the unit. If you attempt to restart before this time delay, the refrigerator will not start.

CHANGING THE REVERSIBLE DOOR

This refrigerator is built with a reversible door. You have the choice of either opening it from the left or the right side. In order to reverse the opening direction of your door, please follow these simple instructions.

Caution: To avoid personal injury to yourself and/or property, we highly recommend that someone assist you during the door reversal process.

- 1) Remove all the door baskets and remove the top hinge assembly and keep them for later use.

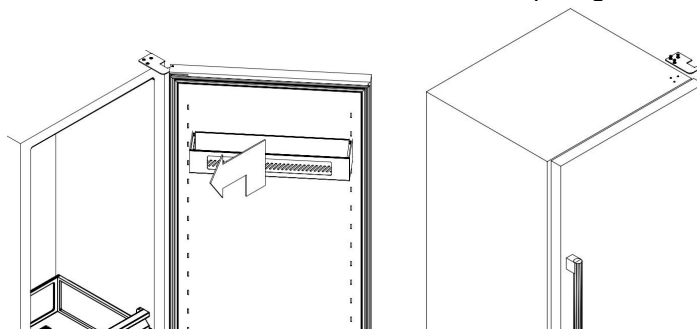

- 2) Lift the door, remove from bottom hinge, turn over 180°, place it on a padded surface to prevent damage and scratches.

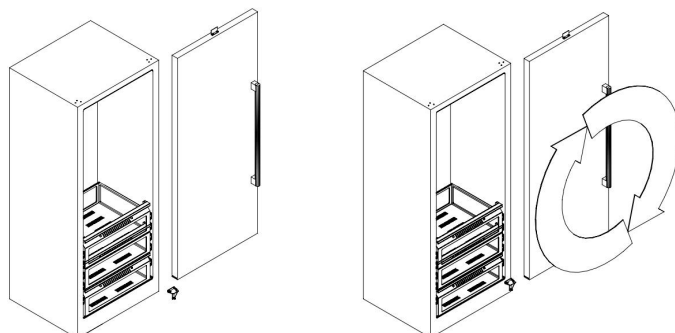

- 3) Remove the bottom hinge assembly and keep them for later use.
- 4) Remove the plug buttons from the upper left holes and transfer them to the uncovered holes on the right side. Be sure to press the plug buttons firmly into the hole.
- 5) Take the other bottom hinge from the part's bag and install it on the left bottom.
- 6) Re-install the top hinge assembly previously removed in step 1 on the opposite side.
- 7) Remove the block sheet of light switch and re-install it on door's bottom.
- 8) Ensure that the door assembly is properly aligned with cabinet before tightening the screws.

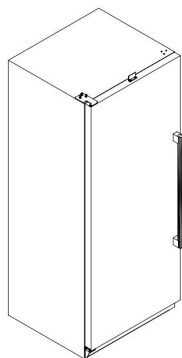

CARE AND MAINTENANCE

Cleaning Your Appliance

- Upon installation of your new appliance, it is recommended that it be cleaned thoroughly.
- Turn off the refrigerator first and then unplug the unit from the wall outlet.
- Remove all contents.
- Wash the inside with a damp warm cloth soaked in lukewarm water and baking soda solution. The solution should be about 2 tablespoons of baking soda to a quart of water.
- Be sure to keep the door gasket (seal) clean to keep the unit running efficiently.
- The outside of the refrigerator should be cleaned with mild detergent and warm water.
- Dry the interior and exterior with a soft cloth.

Power Failure

Most power failures are corrected within a few hours and should not affect the temperature of your Appliance if you minimize the number of times the drawer is opened. If the power is going to be off for a longer period of time, you need to take the proper steps to protect the contents.

Vacation Time

- Turn off the refrigerator first and then unplug the unit from the wall outlet.
- Remove all the contents.

- Clean the appliance.
- Leave the lid open slightly to avoid possible formation of condensation, mold, or odors.
- Short vacations: Leave the refrigerator operating during vacations of less than three weeks.
- Long vacations: If the refrigerator will not be used for several months, remove all content and unplug the power cord. Clean and dry the interior thoroughly. To prevent odor and mold growth, leave the door open slightly: blocking it open if necessary.

Moving Your Appliance

- Turn off the refrigerator first and then unplug the unit from the wall outlet.
- Remove all the contents.
- Securely tape down all loose items inside your appliance.
- Tape the doors shut.

Energy Saving Tips

- The refrigerator should be located in the coolest area of the room, away from heat producing appliances or heating ducts, and out of the direct sunlight.
- Ensure that door is properly closed when the wine cooler is turned on.

TROUBLESHOOTING GUIDE

You can solve many common refrigerator problems easily, saving you the cost of a possible service call. Try the suggestions below to see if you can solve the problem before calling for service.

PROBLEM	POSSIBLE CAUSE
Refrigerator does not operate.	<ul style="list-style-type: none"> • Not plugged in. • The circuit breaker tripped or a blown fuse.
Refrigerator compartments are too warm	<ul style="list-style-type: none"> • Temperature control is not set correctly. • Door is left open or is frequently opened. • The door gasket does not seal properly. • A large amount of warm or hot food was stored recently. Wait for the refrigerator to reach its selected temperature. • The refrigerator has recently been disconnected for a period of time.
Vibrating or rattling (slight vibration is normal)	<ul style="list-style-type: none"> • Leveling legs need adjusting. • Refrigerator is placed on an uneven or weak surface. • The refrigerator is touching the wall. Re-level the refrigerator and move it away from the wall.
Temperature of external refrigerator surface is warm	<ul style="list-style-type: none"> • The exterior refrigerator walls can be as much as 30°F warmer than room temperature. • This is normal while the compressor works to transfer heat from inside the refrigerator cabinet.
Moisture collects inside the refrigerator	<ul style="list-style-type: none"> • Door is left open or is frequently opened.
Moisture forms on outside of appliance.	<ul style="list-style-type: none"> • Is normal in hot and humid weather. Air carries moisture into the refrigerator when doors are opened.
Bubbling or gurgling sounds (like boiling water)	This is the normal sound of refrigerant (used to cool refrigerator) circulating throughout the system.

Popping or cracking sounds when compressor comes on	<ul style="list-style-type: none"> • This is normal. Metal parts undergo expansion and contraction, like hot water pipes. The sound will level off or disappear as refrigerator runs.
The door will not close proper	<ul style="list-style-type: none"> • The refrigerator is not on a level surface. • The gasket is dirty. • The storage basket is out of posit

WARNING

1.WARNING – Keep ventilation openings, in the appliance enclosure or in the built-in structure, clear of obstruction.

2.WARNING – Do not use mechanical devices or other means to accelerate the defrosting process, other than those recommended by the manufacturer.

3.WARNING – Do not damage the refrigerant circuit.

4.WARNING – Do not use electrical appliances inside the food storage compartments of the appliance, unless they are of the type recommended by the manufacturer.

5.Do not store explosive substances such as aerosol cans with a flammable propellant in this appliance.

6.WARNING – To avoid a hazard due to instability of the appliance, it must be fixed in accordance with the instructions.

7.Correct Disposal of this product:

To prevent possible harm to the environment or human health from uncontrolled waste disposal, recycle it responsibly to promote the sustainable reuse of material resources. To return your used device, please use the return and collection systems or contact the retailer where the product was purchased. They can take this product for environmental safe recycling.

This appliance is not intended for use by persons (including children) with

reduced physical, sensory or mental capabilities, or lack of experience and knowledge, unless they have been given supervision or instruction concerning use of the appliance by a person responsible for their safety.

Children should be supervised to ensure that they do not play with the appliance.

Wire diagram

