



FFFFD1907-33SB
33" French Door Refrigerator

BEFORE USE, PLEASE READ AND FOLLOW ALL SAFETY RULES AND OPERATING INSTRUCTIONS. RETAIN THIS INSTRUCTION MANUAL IN A SAFE PLACE FOR FUTURE REFERENCE. IF YOU TRANSFER THE APPLIANCE TO A THIRD PARTY, ALSO HAND OVER THIS INSTRUCTION MANUAL.

Index

Customer Care	2
Safety information	4
Signal words	5
Safety instructions	5
Climatic classes	8
Installation	8
Accessories	9
Door handle installation	9
Space and ventilation requirements	10
Leveling	11
Flipper clapboard	12
Operation	12
Description of the appliance	13
Operating buttons and display	14
Key lock / Child protection	15
Setting of the temperature	15
Selection of the modes	16
Sabbath control mode steps	18
Door alarm	19
The refrigerator	19
Door trays	20
Glass shelves	20
The freezer	20
Environmental protection	21
Energy saving	21
Meaning of the *-labeling of freezers	22
Storage of food	23
Operational parameters	25
Cleaning and maintenance	26
Defrosting	27
Replacing of the illuminate	28
Replacing of the power cord	28
Trouble shooting	28
Decommissioning	30
Technical data	31
Waste management	31
Wire Diagram	32

Customer Care

Thank you for purchasing a FORNO product. Please read the entire instruction manual before operating your new appliance for the first time. Whether you are an occasional user or an expert, it will be beneficial to familiarize yourself with the safety practices, features, operation and care recommendations of your appliance.

Both the model and serial number are listed on the product. For warranty purposes, you will also need the date of purchase. Record this information below for future reference.

SERVICE INFORMATION

Model Number:

Use these numbers in any correspondence or service calls concerning your appliance.

Serial Number:

If you received a damaged appliance, immediately contact the dealer (or builder) that sold you the appliance

Date of Purchase:

Purchase Address & Phone:

Save time and money. Before you call for service, check the Troubleshooting Guide. It lists the causes of minor operating problems that you can correct yourself.

SERVICE IN CANADA:

Keep the instruction manual handy to answer your questions. If you don't understand something or you need more assistance, please call our Customer Service: 1-800-561-7265

Or email: service@distinctive-online.com

SERVICE IN THE UNITED STATES:

Keep the instruction manual handy to answer your questions. If you don't understand something or you need more assistance, please call our Customer Service: 1-866-231-8893

Or email: info@forno.ca

Digital instruction manual can be downloaded from www.forno.ca

If your appliance ever requires servicing, be sure to use a **FORNO** Factory Certified Service provider recommended by our customer care center. All Factory Certified Service providers are carefully selected and thoroughly trained by us.

This appliance can be used by children aged from 8 years and above and persons with reduced physical, sensory or mental capabilities or lack of experience and knowledge if they have been given supervision or instruction concerning use of the appliance in a safe way and understand the hazards involved. Children aged from 3 to 8 years are allowed to load and unload refrigerating appliances. Children shall not play with the appliance. Cleaning and user maintenance shall not be made by children without supervision.

If the supply cord is damaged, it must be replaced by the manufacturer, its service agent or similarly qualified persons in order to avoid a hazard.

 **WARNING:** Keep ventilation openings, in the appliance enclosure or in the built-in structure, clear of obstruction.

 **WARNING:** Do not use mechanical devices or other means to accelerate the defrosting process, other than those recommended by the manufacturer.

 **WARNING:** Do not damage the refrigerant circuit.

 **WARNING:** Do not use electrical appliances inside the food storage compartments of the appliance, unless they are of the type recommended by the manufacturer.

Correct Disposal of this product



This marking indicates that this product should not be disposed with other household wastes. To prevent possible harm to the environment or human health from uncontrolled waste disposal, recycle it responsibly to promote the sustainable reuse of material resources.

Do not store explosive substances such as aerosol cans with a flammable propellant in this appliance. This appliance is intended to be used in household and similar applications such as

- staff kitchen areas in shops, offices and other working environments;
- farm houses and by clients in hotels, motels and other residential type environments;
- bed and breakfast type environments;
- catering and similar non-retail applications

 **WARNING:** When positioning the appliance, ensure the supply cord is not trapped or damaged.

 **WARNING:** Do not locate multiple portable socket-outlets or portable power supplies at the rear of the appliance. **RISK OF FIRE!**

To avoid contamination of food, please respect the following instructions:

- Opening the door for long periods can cause a significant increase of the temperature in the compartments of the appliance.
- Clean regularly surfaces that can come in contact with food and accessible drainage systems.
- Store raw meat and fish in suitable containers in the refrigerator, so that it is not in contact with or drip onto other food.
- If the **refrigerating appliance is left empty for long periods, switch off, defrost, clean, dry, and leave** the door open to prevent mould developing within the appliance.



Do not dispose of this appliance together with your domestic waste. The appliance must be disposed of at a collecting centre for recyclable electric and electronic appliances. Do not remove the symbol from the appliance.

⚠ The figures in this instruction manual may differ in some details from the current design of your appliance. Nevertheless, follow the instructions in such a case. Delivery without content .

⚠ Any modifications, which do not influence the functions of the appliance . shall remain reserved by the manufacturer.

⚠ Please dispose of the packaging with respect to your current local and municipal regulations.

⚠ The appliance you have purchased may be an enhanced version of the unit this manual was printed for. Nevertheless, the functions and operating conditions are identical. This manual is therefore still valid. Technical modifications as well as misprints shall remain reserved

MAKE SURE THAT THIS MANUAL IS AVAILABLE TO ANYONE USING THE APPLIANCE AND MAKE SURE THAT IT HAS BEEN READ AND UNDERSTOOD PRIOR TO USING THE DEVICE.

Safety information

READ THE SAFETY INFORMATION AND THE SAFETY INSTRUCTIONS CAREFULLY BEFORE YOU OPERATE THE APPLIANCE FOR THE FIRST TIME.

All information included in those pages serve for the protection of the operator. If you ignore the safety instructions, you will endanger your health and life.

⚠ Store this manual in a safe place so you can use it whenever it is needed. Strictly observe the instructions to avoid damage to persons and property.

⚠ Check the technical periphery of the appliance! Do all wires and connections to the appliance work properly? Or are they time-worn and do not match the technical requirements of the appliance? A check-up of existing and newly-made connections must be done by an authorized professional. All connections and energy-leading components (incl. wires inside a wall) must be checked by a qualified professional. All modifications to the electrical mains to enable the installation of the appliance must be performed by a qualified professional.

⚠ The appliance is intended for private use only as well as to be used (1) in staff kitchen areas of shops, offices and other working environments; (2) by clients in hotels, motels, B&B and other residential type environments; (3) for catering and similar non-retail applications.

⚠ The appliance is intended for cooling food only.

⚠ The appliance is intended for indoor-use only.

⚠ The appliance is not intended to be operated for commercial purposes, during camping and in public transport.

⚠ Operate the appliance in accordance with its intended use only.

⚠ Do not allow anybody who is not familiar with this instruction manual to operate the appliance.

⚠ This appliance may be operated by **children** aged from 8 years and above as well as by

persons with reduced physical, sensory and mental capabilities or lack of experience and knowledge if they are supervised or have been instructed concerning the safe use of the appliance and do comprehend the hazards involved. **Children** must not play with the appliance. Cleaning and **user-maintenance** must not be carried out by **children** unless they are supervised.

Signal words

<p>⚠ DANGER! indicates a hazardous situation which, if ignored, will result in death or serious injury.</p>	<p>⚠ WARNING! Indicates a hazardous situation which, if ignored, could result in death or serious injury.</p>
<p>⚠ CAUTION! Indicates a hazardous situation which, if not avoided, may result in minor or moderate injury.</p>	<p>NOTICE! Indicates possible damage to the appliance.</p>

Safety instructions

⚠ DANGER!

To reduce the risk of electrocution:

1. Non-compliance of the orders of this instruction manual will endanger the life and health of the operator and/or can result in damages to the appliance.
2. **Do not connect** the appliance to the mains if the appliance itself or the power cord or the plug are visibly damaged.
3. The technical data of your energy supplier **must** meet the data on the rating plate of the appliance.
4. Do not modify the plug provided with the appliance, if it will not fit the outlet, have a proper outlet installed by a qualified electrician (**not covered by the guarantee**).
5. Never try to repair the appliance yourself. If the appliance does not operate properly, please contact the shop you purchased the appliance at. Original spare parts should be used only.
6. Always check that the power cord is not placed under the appliance or damaged by moving the appliance.
7. When the power cord is damaged, it must be replaced by the manufacturer or an authorized customer service or a qualified professional only.
8. **Never** pull the power supply cable to unplug the appliance. Always use the power plug itself to unplug the appliance. **RISK OF ELECTRIC SHOCK!**
9. **Never** touch the power plug, the power switch or other electrical components with wet or damp hands. **RISK OF ELECTRIC SHOCK!**

⚠ DANGER – Risk of fire or explosion. Flammable refrigerant used. Do not use mechanical devices to defrost refrigerator. Do not puncture refrigerant tubing.

⚠ DANGER – Risk of fire or explosion. Flammable refrigerant used. To be repaired only by trained service personnel. Do not puncture refrigerant tubing.

⚠ CAUTION – Risk of fire or explosion. Flammable refrigerant used. Consult repair manual/owner's guide before attempting to service this product. All safety precautions must be followed.

⚠ CAUTION – Risk of fire or explosion. Dispose of property in accordance with federal or local regulations. Flammable refrigerant used.

⚠ CAUTION – Risk of fire or explosion due to puncture of refrigerant tubing; Follow handling instructions carefully. Flammable refrigerant used.

⚠ DANGER - Risk of child entrapment. Before you throw away your old refrigerator or freezer: Take off the doors.

Leave the shelves in place so that children may not easily climb inside.

⚠ WARNING!

To reduce the risk of burns, electrocution, fire or injury to persons:

1. This appliance is equipped with the environmental-friendly refrigerant R600a. **The refrigerant R600a is inflammable.** The components of the cooling circuit must neither be damaged during transport nor use.
2. If any part of the cooling circuit is damaged, **the appliance must not stand** near a fire, naked light or spark-generating devices.
Contact the customer service or the shop you purchased the appliance immediately.
3. **If gas is set free at the installation site:**
 - a) Open all windows.
 - b) **Do not** unplug the appliance and **do not** use the control panel or thermostat.
 - c) **Do not** touch the appliance until all the gas has gone.
 - d) Otherwise sparks can be generated which will ignite the gas.
4. Keep all components of the appliance away from fire and other sources of ignition when you dispose of or decommission the appliance.
5. Do not install the appliance near of volatile or combustible materials (e.g. gas, fuel, alcohol, paints) and in rooms which may have poor air circulation (e.g. garage).
6. **EXPLOSION HAZARD!** Do not store any explosive materials or sprays, which contain flammable propellants, in your appliance. Explosive mixtures can explode there.
7. While unpacking, the packaging materials (polythene bags, polystyrene pieces, etc.) should be kept away from children and pets. **CHOKING HAZARD! RISK OF INJURY!**
8. Always observe the required minimum distances for proper ventilation.
9. Do not connect the appliance to the electric supply unless all packaging and transit protectors have been removed.
10. Operate the appliance with 115V/60Hz/AC only. All connections and energy-leading components must be replaced by an authorized professional. Do not use a socket board or a multi socket when connecting the appliance to the mains.
11. A dedicated and properly grounded socket meeting the data of the plug is required to minimize any kind of hazard. The appliance must be grounded properly.
12. Always check that the power cord is not placed under the appliance or damaged by moving the appliance.
13. The technical data of your energy supplier must meet the data on the model plate of the appliance.
14. Your domestic circuit must be equipped with an automatic circuit breaker.
15. Do not modify the appliance.
16. Turn off the power before you install the appliance and before you connect it to the mains.
RISK OF FATAL ELECTRIC SHOCK!
17. Disconnect the appliance from the mains before you clean or maintain it. **RISK OF ELECTRIC SHOCK!**
18. Remove possible dust accumulation at the power plug, at the safety power socket and at all plug connectors **regularly. RISK OF FIRE!**
19. Keep the cord away from heated surfaces.
20. The power plug must always be accessible after installation.
21. Do not use a socket board or a multi socket when connecting the appliance to the mains.
22. Do not connect the appliance to an energy saving plug (e.g. Sava Plug) and to inverters which convert direct current (DC) into alternating current (AC), e.g. solar systems, power supply of ships.

23. Do not use any electric appliances inside the food storage compartments of your appliance unless they are recommended by the manufacturer of your refrigerator.
24. Do not put any heat-radiating appliances onto your appliance.
25. Do not install the appliance in a place where it may come in contact with water/rain; otherwise the insulation of the electrical system will be damaged.
26. Do not put a water-boiler or vases onto your appliance. The electrical components of your appliance can be seriously damaged by water over-boiling or spilled water.
27. Do not use any steam cleaners to clean or defrost the appliance. The steam can get into contact with the electrical parts and cause an electrical short. **RISK OF ELECTRIC SHOCK!**
28. Never use mechanic devices, knives or other sharp-edged items to remove encrusted ice inside the appliance. **RISK OF ELECTRIC SHOCK** caused by damaging the interior of the appliance.
29. Do not eat food which is still frozen. The coldness can cause injuries in the mouth.
30. Contact with frozen food, ice and metal components in the freezer compartment can cause injuries similar to burns.
31. Children must never play with the appliance.
32. **If you decommission your appliance** (even temporarily), **ensure that children cannot get into the appliance**. Strictly observe the corresponding safety instructions numbers. 1 and 4, chapter DECOMMISSIONING, ultimate.
33. Strictly observe the instructions in chapter INSTALLATION.

CAUTION!

1. The condenser and the compressor, located at the rear of the appliance, can reach high temperatures during ordinary operation. Carry out the installation according to this manual. An insufficient ventilation of the appliance will impair its operation and will damage the appliance. Do not cover or block the ventilation slats at any time.
2. **Do not put any bottled or canned beverages (neither still nor carbonated)** into the 0* - compartment of the appliance as their containers could explode.
3. Do not touch extremely cooled surfaces with wet or damp hands, because your skin may stick on these surfaces.

NOTICE!

1. Do not store dry ice in the appliance.
2. When you move the appliance, hold it at its base and lift it carefully. Keep the appliance in an upright position.
3. When you move the appliance using the rollers (depending on model), only move it forwards or backwards as the rollers are not pivotable and do not allow any lateral motion. Lateral motion can damage the appliance and floor seriously.
4. Do not tilt the appliance more than 45° .
5. If the appliance is transported in a horizontal position, some oil may flow from the compressor into the refrigerant circuit.
6. Leave the appliance in an upright position for **4 - 6 hours** before you switch it on to ensure, that the oil has flowed back into the compressor.
7. If you use the appliance for the first time or the appliance has been disconnected from the mains for a longer period of time, allow the appliance to cool down for 3 until 4 hours on medium temperature setting **before** you place any fresh or frozen food in the appliance. If you place food in the appliance before it has reached its normal operating temperature, this food can thaw and / or spoil.
8. Never use the door for moving the appliance as you will damage the hinges.
9. The appliance must be transported and installed by at least **two persons**.

10. When you unpack the appliance, you should take note of the position of every part of the interior accessories in case you have to repack and transport it at a later point of time.
11. Do not operate the appliance unless all components are installed properly.
12. Do not stand or lean on the base, the drawers, the doors etc. of the appliance.
13. Never close the doors of the appliance while shelves or drawers are extended, otherwise you will damage the shelves / drawers and the appliance.
14. Do not put hot liquids or hot foodstuff into the appliance.
15. The air vents of the appliance or its built-in structure (if the appliance is suitable for being built-in) must be completely open, unblocked and free of any kind of dirt.
16. Do not place any food directly against the air outlet on the rear wall.
17. Do not overfill the shelves / drawers /door trays to protect them from damage.
18. Clean the appliance **at least** once a month (see chapter **CLEANING AND MAINTENANCE**).
19. Empty and clean the drip tray regularly.
20. The rating plate **must not** be removed or made illegible, **otherwise all terms of the warranty become invalid!**

SAVE THESE INSTRUCTIONS.

✘The manufacturer and distributor are not responsible for any damage or injury in the event of failure to comply with these instructions.

Climatic classes

Look at chap. TECHNICAL DATA for information about the climatic class of your appliance. Your appliance can be operated in rooms with relevant room temperatures as named below.

CLIMATIC CLASS	AMBIENT TEMPERATURE
SN	+10°C(50°F) →+32°C(89.6°F) e.g. unheated cellar
N	+16°C(60.8°F) →+32°C(89.6°F) inner home temperature
ST	+16°C(60.8°F) →+38°C(100.4°F)inner home temperature
T	+16°C(60.8°F) →+43°C(109.4°F)inner home temperature

Installation

⚠All dimensions in these chapters are given in **millimeters** .

⚠The minimum distances required for proper ventilation can be found in chapter VENTILATION.

Unpacking and positioning

⚠**WARNING!** While unpacking, the packaging materials (polythene bags, polystyrene pieces, etc.) should be kept away from children and pets. **CHOKING HAZARD! RISK OF INJURY!**

1. Unpack the appliance carefully. Dispose of the packaging as described in chapter waste management.
2. Remove all packaging materials.
3. The accessories of your appliance can be protected from damage due to transportation (adhesive tapes etc.). Remove such tapes very carefully. Remove remains of such tapes with a



damp cloth using lukewarm water and mild detergent (see also chapter **CLEANING AND MAINTENANCE**). Never remove any components of the back of the appliance!

4. Install the appliance in a suitable position with an adequate distance from sources of heat and cold.
5. If installation near a heat source is unavoidable, use a suitable insulation plate or keep the following **minimum distances** to the heat source:

To electric cookers	At least 30mm
To radiators or ovens	At least 300mm
To another refrigerators	At least 20mm

6. Check that the appliance and the power cord are not damaged.
7. Install the appliance in a dry and well-ventilated place.
8. Protect the appliance from direct sunlight.
9. The door(s) must open completely and without hindrance.
10. Install the appliance on a level, dry and solid floor. Check the correct installation with a bubble level.
11. Connect the appliance to the mains properly.
12. The rating plate is inside the appliance or at the back

Accessories

	Door handle	2pcs
	Allen wrench	1pc

Door handle installation

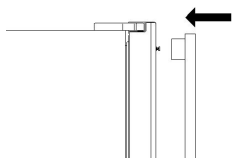
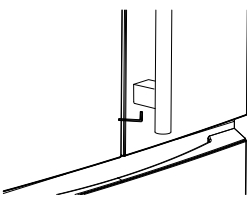
<p>1. Align the two holes on the handle with the bolts on the fridge door, push the handle to the door until it fits the fridge door closely;</p>	
<p>2. Use Allen wrench to tighten the screws on two ends of handle.</p>	

Space and ventilation requirements

- ⚠ Observe the required minimum distances for proper ventilation.
- ⚠ All dimensions in this chapter are given in **millimeters**

Space requirements of the appliance

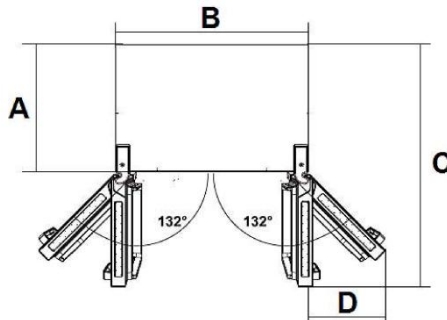

A = Depth / B = Width / C = Depth (when the doors are open) / D = Space requirement of the doors

A	B	C	D
600mm	830mm	1018mm	300mm
Door opening angle		Mind. 132°	

Ventilation

Minimum distances

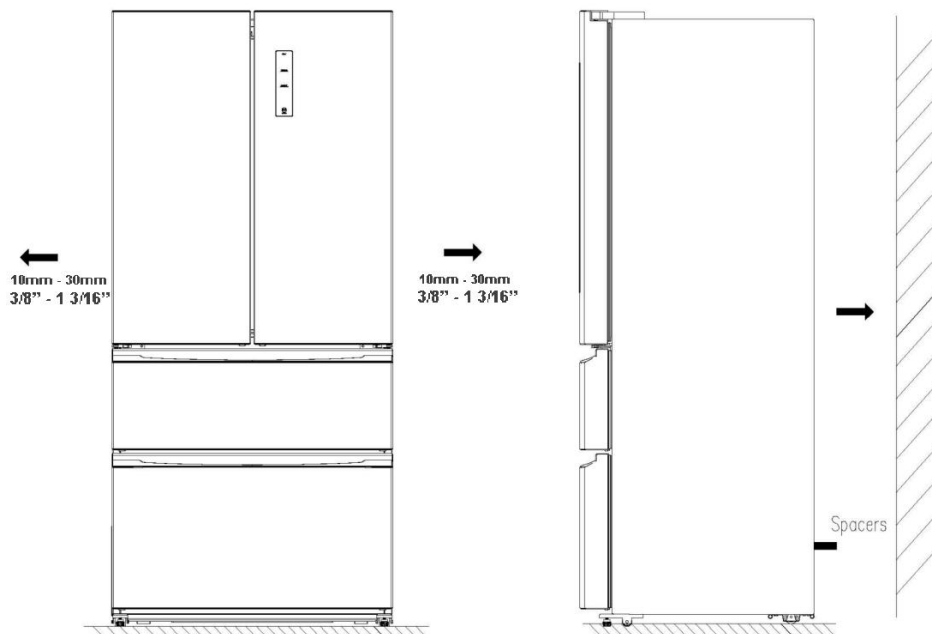

- ⚠ Observe the required minimum distances for proper ventilation

MINIMUM DISTANCES REQUIRED FOR PROPER VENTILATION:	
Back ↔ wall	Mind. 50mm
Sides ↔ wall	Mind. 30cm
Door opening angle	Mind. 132°

SPACE REQUIREMENT INCL. MINIMUM DISTANCES FOR PROPER VENTILATION:

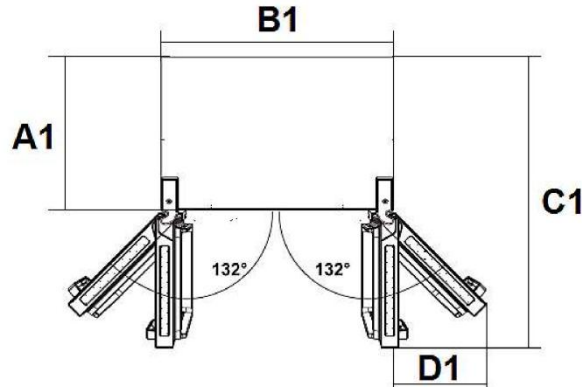

A 1= Depth / B 1 = Width / C 1 = Depth (when the doors are open) /

D 1 = Space requirement of the doors

A1	B1	C1	D1
Mind. 620mm	Mind. 870mm	Mind. 1038mm	Mind. 300mm
Door opening angle:		mind. 132°	

⚠ These minimum distances may be less, but to do so can increase the power consumption of the appliance.

Leveling

>Use the adjustable supporting feet for proper leveling and for proper air circulation in the lower sectors of the appliance. Adjust the supporting feet / foot using a suitable spanner.

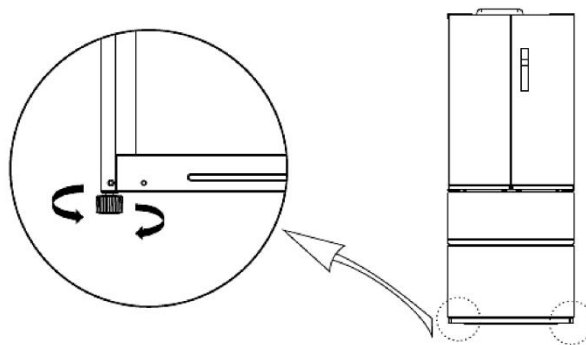

The figure above is an example only. Modifications are possible

>You can adjust an inclination of 0.5 ° to allow the doors to close by themselves.

>If you have to move the appliance, set the adjustable feet to minimum position so the appliance can be moved on its rollers (depending on model) easily. Re-adjust the appliance when transport has been completed.

NOTICE! The rollers are no castors and intended to move the appliance forward and backwards only. Lateral movements can damage your floor and the rollers.

Flipper clapboard

1. Ensure that the flipper clapboard (depending on model) is in proper position; otherwise the door cannot be closed properly.
2. It is normal that the clapboard becomes hot as it is equipped with an integrated heating element for dewing protection

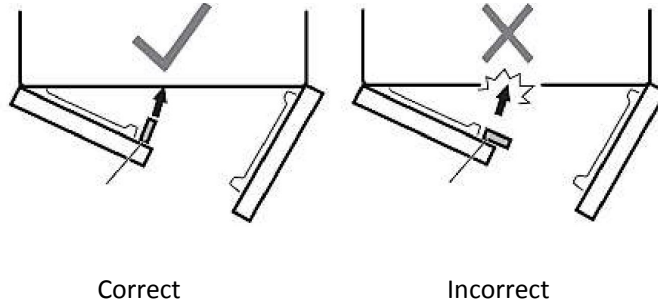

Operation

⚠ WARNING! To disconnect the appliance from the mains, you must unplug the appliance or use a cut-off device

Before initial operation

⚠ WARNING! While unpacking, the packaging materials (polythene bags, polystyrene pieces, etc.) should be kept away from children and pets. **CHOKING HAZARD! RISK OF INJURY!**

NOTICE! Leave the appliance in an upright position for **at least 4 – 6 hours** before you connect it to the mains to ensure, that the oil has flowed back into the compressor.

NOTICE! If you use the appliance for the first time or the appliance has been disconnected from the mains for a longer period of time, allow the appliance to cool down for 3 until 4 hours on medium temperature setting (s. chapter **SETTING OF THE TEMPERATURE**) **before** you place any fresh or frozen food in the appliance. If you place food in the appliance before it has reached its normal operating temperature, this food can thaw and / or spoil.

1. Remove all packaging materials.
2. Adjust the feet and clean the appliance (see chapter **CLEANING AND MAINTENANCE**).
3. Do not start the appliance immediately after installation. Wait at least 4 – 6 hours to ensure proper operation.
4. The settings of the temperature of the fridge can be adjusted manually. To do this, turn the thermostat for the temperature to the desired setting. (see chapter **SETTING OF THE TEMPERATURE**).
5. If operation was interrupted, wait **at least 5 minutes** before restart.
6. The appliance needs some time to balance temperatures when you have changed the settings before or when you have stored additional food in the appliance. The duration of this period of time depends on the range of the change, the ambient temperature, the amount of food and the frequency of door-openings. When you set the temperature of both the fridge and freezer,

these aspects should be taken into account.

7. Operate the appliance according to the instructions described in the following chapters.

Description of the appliance

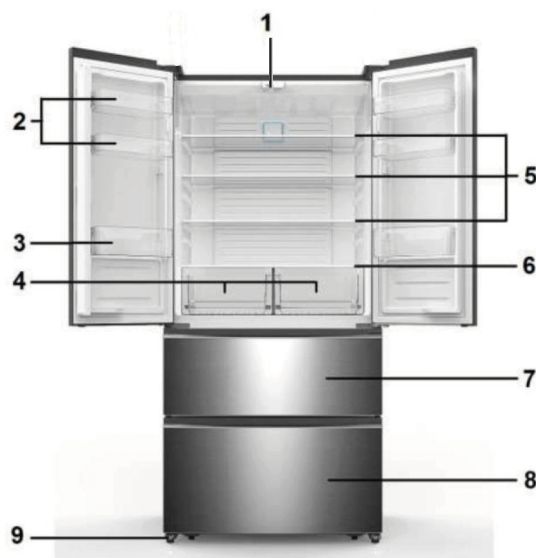

The figure above is an example only. Modifications are possible.

Fridge	
1	Internal light of the fridge (LED)
2	Door trays
3	Bottle shelf
4	Crispers
5	Glass shelves
6	Break-proof glass covers of the crispers
Freezer	
7	Upper freezer drawer / freezer compartment
8	Lower freezer drawer / freezer compartment
9	Adjustable feet

AFTER INSTALLATION WAIT 4-6 HOURS BEFORE YOU CONNECT YOUR APPLIANCE TO THE MAINS!

⚠ The glass shelves and the crisper can be removed and inserted for cleaning and storing of food according to the appliance.

⚠ The appliance you have purchased may be an enhanced version of the unit this manual was printed for. Nevertheless, the functions and operating conditions are identical. This manual is therefore still valid.

Operating buttons and display

⚠ WARNING! To disconnect the appliance from the mains, you must unplug the appliance or use a cut-off device.

※ Operate the appliance according to the instructions about the control of the functions and modes described in the following paragraphs

※ When you operate the appliance for the first time, the **default** temperatures are:

Fridge	+ 5 °C(41°F)
Freezer	- 18 °C(- 0.4°F)

※ The settings of the temperature of both the fridge and freezer can be adjusted manually, if required (see chapter **SETTING OF THE TEMPERATURE**)

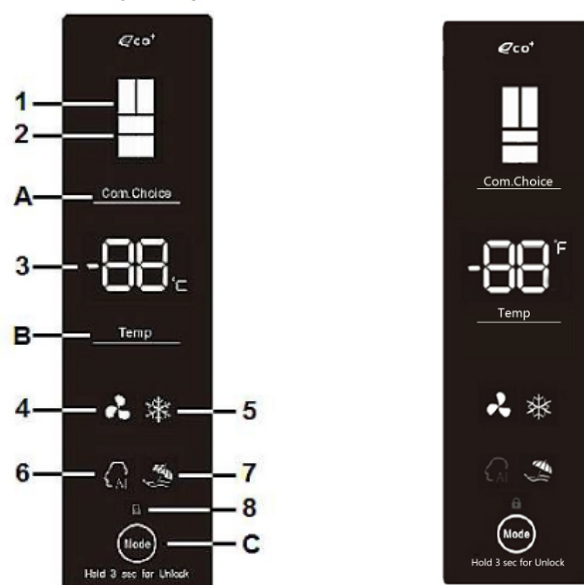

INDICATORS OF THE DISPLAY:

1	Indicator of the FRIDGE
2	Indicator of the FREEZER
3	Indicator of the set TEMPERATURE of the fridge or freezer
4	Indicator of the FAST COOLING MODE
5	Indicator of the FAST FREEZING MODE
6	Indicator of the ARTIFICIAL INTELLIGENCE MODE
7	Indicator of the VACATION MODE
8	Indicator of the KEY LOCK / CHILD PROTECTION

OPERATING BUTTONS OF THE DISPLAY:

A	Button: COM.CHOICE (compartment choice): selection of the fridge or freezer (SELECTION OF THE COMPARTMENT for the setting of the temperature). Long press for 5 seconds to switch from Celsius to Fahrenheit
B	Button TEMP : SETTING OF THE TEMPERATURE in the fridge or freezer.
C	Button MODE : selection of the different MODES AND FUNCTIONS and to lock and / or unlock the KEY LOCK / CHILD PROTECTION

DISPLAY:

※ If you connect the appliance to the mains, the backlight of the display goes on.



※ If you do not press any operating button and the doors are closed, the backlight of the

display goes off.

※During normal operation the display indicates the set temperature of the fridge **or** freezer.

Key lock / Child protection

※The appliance is equipped with a KEY LOCK / CHILD PROTECTION.

ACTIVATION OF THE KEY LOCK / CHILD PROTECTION:
※Press the button MODE (C) for 3 seconds to turn the KEY LOCK / CHILD PROTECTION on .
>The indicator of the KEY LOCK / CHILD PROTECTION  (8) goes on.
>All keys of the display are locked
DEACTIVATION OF THE KEY LOCK / CHILD PROTECTION:
※Press the button MODE (C) for 3 seconds to turn the KEY LOCK / CHILD PROTECTION off .
>The indicator of the KEY LOCK / CHILD PROTECTION (8)  goes off.
>All keys of the display are released again.

If the KEY LOCK / CHILD PROTECTION is activated, **none** of the following settings below can be carried out.

Setting of the temperature

>The settings of the temperature of both the fridge and freezer can be adjusted manually by pressing the relevant buttons (button **COM. CHOICE (A)** for the selection of the compartment = fridge **or** freezer / button **TEMP (B)** for the setting of the temperature in the respective compartments) until the desired values will be indicated (see chapter **OPERATING BUTTONS AND DISPLAY**).



>When you set a temperature, you set an average temperature for the whole refrigerator. Temperatures inside each area may vary from the temperature values indicated on the display, depending on how much food you store and where you place them. Ambient temperature may also affect the actual temperature inside the appliance. When you set the temperature of both the fridge and freezer these aspects should be taken into account.

WHEN YOU OPERATE THE APPLIANCE FOR THE FIRST TIME, THE DEFAULT TEMPERATURES ARE (ARTIFICIAL INTELLIGENCE MODE):	
Fridge	+5°C (41°F)
Freezer	-18°C (- 0.4°F)

 The ARTIFICIAL INTELLIGENCE MODE (fridge: + 5 °C (41°F)/ freezer: - 18 °C (- 0.4°F)) is the **default mode** of the appliance (s. chapter 4.6 SELECTION OF THE MODES).

 These settings can be changed as needed.

 **To perform the following settings the display must be unlocked.**

REFRIGERATOR:
※You can set the temperature from +8 °C(46.4°F) to +2 °C(35.6°F) .
>Press the button COM. CHOICE (A) repeatedly until the indicator of the fridge (1) goes on. 
>Press the button TEMP (B) for the setting of the temperature repeatedly 

until the desired temperature is displayed (3)

- >After a few seconds **without** using any operation buttons, the settemperature will be activated
- >The temperature changes by 1°C(33.8°F)each time you press the Button **TEMP (B)**
- >The sequence ofthe temperature setting is:

FREEZER:

- ※You can setthe temperature from **-15 °C(5°F)to -25 °C(-13°F)**.
- >Press the button **COM. CHOICE (A)** repeatedly until the indicator ofthe freezer (2) goes on.
- >Press the button **TEMP (B)** for the setting ofthe temperature repeatedly until the desired temperature is displayed (3).
- >After a few seconds **without** using any operation buttons, the settemperature will be activated.
- >The temperature changes by 1 °C(33.8°F)each time you press the button **TEMP (B)**.
- >The sequence ofthe temperature setting is:

Selection ofthe modes

- ※You can selectthe modes by pressing the **MODE BUTTON (C)** repeatedly.
- >Press the **MODE BUTTON (C)** repeatedly until the corresponding indicator ofthe desired mode is selected.
- >For doing so the keys have to be unlocked.



THE FOLLOWING MODES CAN BE SET:
→ARTIFICIAL INTELLIGENCE (AI)
→VACATION MODE
→FAST FREEZING
→FAST COOLING

THE SEQUENCE OF THE MODES IS:

ARTIFICIAL INTELLIGENCE (AI):

⚠The ARTIFICIAL INTELLIGENCE MODE is the **default mode** ofthe appliance.

- ※The temperature ofthe fridge will be setto **+5 °C(41°F)**automatically.
- ※The temperature ofthe freezer will be setto **-18 °C(-0.4°F)**automatically.

⚠If you **have not** configured **individual temperature settings** for the fridge and / or the freezer, the appliance will be resetto the ARTIFICIAL INTELLIGENCE MODE **automatically after** deactivation of one ofthe other modes (VACATION MODE / FAST FREEZING or FAST COOLING).

 If you **have** configured **individual temperature settings** for the fridge and / or freezer, the temperature(s) will be reset to the **previous setting**.

 If the ARTIFICIAL INTELLIGENCE MODE is activated, the appliance operates with the highest efficiency regarding food preservation and food storage.

You can also set the artificial intelligence mode manually at any time:

>Press the **MODE BUTTON (C)** repeatedly until the indicator of the ARTIFICIAL INTELLIGENCE MODE (**6**) goes on.

>After a few seconds **without** using any operation buttons, the ARTIFICIAL INTELLIGENCE MODE will be activated.



VACATION MODE:

>Press the **MODE BUTTON (C)** repeatedly until the indicator of the VACATION MODE (**7**) goes on.

>After a few seconds **without** using any operation buttons, the VACATION MODE will be activated.

>The VACATION MODE can be quitted at any time by pressing the button **TEMP (B)**. The temperature of the fridge will be reset to the previous setting.

※**During the VACATION MODE, the temperature of the fridge will be set to +15°C(59°F)automatically to minimize the energy consumption.**

※During the VACATION MODE, the temperature of the fridge **cannot** be changed. You must quit the VACATION MODE previously (see above).

 Select this mode when you are not at home for a longer period of time (7 – 21 days).

NOTICE! In **VACATION MODE** the fridge will be set to **+15°C(59°F)automatically!** **Do not** leave any food in the fridge while the **VACATION MODE** is activated.



FAST FREEZING:

>Press the **MODE BUTTON (C)** repeatedly until the indicator of the FAST FREEZING MODE (**5**) goes on.

>After a few seconds **without** using any operation buttons, the FAST FREEZING MODE will be activated.

>The FAST FREEZING MODE can be quitted at any time by pressing the button **TEMP (B)**. The temperature of the freezer will be reset to the previous setting.

※The temperature of the freezer will be set to **-25 °C(-13°F)automatically.**

※After **26 hours** the FAST FREEZING MODE switches off **automatically** and the temperature of the freezer will be reset to the previous setting.

※During the FAST FREEZING MODE, the temperature of the fridge **cannot** be changed. You must quit the FAST FREEZING MODE previously (see above).

※When the FAST FREEZING MODE is activated, the temperature of the refrigerator does not change.

 This function decreases the freezing temperature rapidly and makes sure that the food will be frozen faster as usual. Thereby this function helps to preserve vitamins and nutrients of fresh food for a longer period of time.

 Select this mode when you like to freeze fresh meat or fish for long term storage.

 **CAUTION! Do not put any bottled or canned beverages (neither still nor carbonated)**

into the freezer compartment of the appliance as their containers could explode .



FAST COOLING:

>Press the **MODE BUTTON (C)** repeatedly until the indicator of the FAST COOLING MODE (**4**) goes on.

>After a few seconds **without** using any operation buttons, the FAST COOLING MODE will be activated.

>The FAST COOLING MODE can be quitted at any time by pressing the button **TEMP (B)**. The temperature of the fridge will be reset to the previous setting

※The temperature of the fridge will be set to **+2 °C(35.6°F)**automatically.

※During the FAST COOLING MODE, the temperature of the fridge **cannot** be changed. You must quit the FAST COOLING MODE previously (see above).

※After **3 hours** the FAST COOLING MODE switches off **automatically** and the temperature of the fridge will be reset to the previous setting.

 This function decreases the refrigeration temperature rapidly and makes sure that the food will be cooled faster as usual. Thereby this function helps to keep the stored food fresh for a longer period of time.

Sabbath control mode steps:

1. When the refrigerator is powered on for the first time, after running for 10 minutes, press and hold the **Temp** and **Com.Choice** key at same time for 5 seconds to enter the Sabbath control mode.
2. When the power is not on for the first time, press and hold **Temp** and **Com.Choice** key for 5 seconds to enter the Sabbath control mode.
3. After entering the Sabbath control mode,press the **Temp** and **Com.Choice** key for 5 seconds to exit and return to the normal control mode.

Door alarm

※The appliance is equipped with an automatic alarm which indicates that one of the doors of the appliance are opened for a longer period of time.

1. If one of the doors is opened for more than 2 minutes, an acoustic warning signals sound.
2. If the door is opened for a prolonged period of time, the acoustic warning signal will sound three times every minute.
3. After 10 minutes the acoustic warning signal will be quitted automatically.

⚠The door alarm can **also** be quitted **permanently** by closing the corresponding door.

⚠In order to save energy a prolonged opening of the doors should be avoided.

The refrigerator

The cooling compartment is not intended for storing food for a longer period of time. So, use the cooling compartment for short-term storage only. Different temperature areas due to the air circulation occur in the appliance. Use these different temperature areas to store different kinds of food.

Shelves	Food from wheat flour, milk etc. The shelves are removable for cleaning. Adjust the shelves relevant to your needs.
Crisper	Fruit, vegetable etc.
Door trays	Eggs, beverage cans, bottled beverages, packaged foodstuffs etc

Store covered or packaged food in the appliance only so the smell or taste of the food will not diffuse. The following materials are suitable for proper packaging:

- ※Food safe cling film/airtight bags and aluminum foil.
- ※Food safe covering hoods.
- ※Food safe containers made of plastic/glass/ceramics.

- ※Store fresh, packaged food on the shelves, fresh fruit and vegetable in the crisper.
- ※Store fresh meat packaged in protective foil for max. 2 days.
- ※Let warm food such as cooked meals cool down before you store them in the appliance.
- ※Store food in such a way that the cooled air can circulate properly.
- ※Do not place heavy bottles in the bottle pocket as it can come off the door.

Door trays

1. Depending on model the medium door trays can be removed.
2. Remove all stored food of the relevant door trays before.
3. Lift the door tray vertically.
4. Insert the door tray by proceeding vice versa.

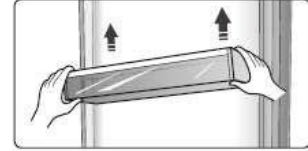

⚠ The door trays can be removed and inserted for cleaning as shown above (depending on model)

Glass shelves

1. The glass shelves can be inserted into different positions 15 if required.
2. Pull the glass shelf on the guide rails forward carefully and lift it slightly until you can remove it.
3. To reinsert the glass shelf, push it back in position on the guide rails carefully.
4. Ensure that the area is free and has no obstacles

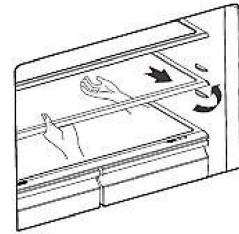

⚠ The glass shelves can be removed and inserted for cleaning as shown above (depending on model).

The freezer

⚠ **WARNING!** Do not eat food which is still frozen. Children should not eat ice-cream straight from the freezer. The coldness can cause injuries in the mouth.

⚠ **WARNING!** Contact with frozen food, ice and metal components in the freezer compartment can cause injuries similar to burns

⚠ **CAUTION!** Do not put any bottled or canned beverages (neither still nor carbonated) into the freezer compartment of the appliance as their containers could explode .

The freezer is intended for long-term storage of food. Please observe the advice for max. storage time on the packaging of frozen food products. Do not refreeze defrosted food.

Shelves	Fish, meat, ice crème etc. The shelves are removable for cleaning. Adjust the shelves relevant to your needs.
Drawer	Packaged frozen foodstuffs.
Door trays	Small pieces of frozen food, short time storage, etc. Do not place too many heavy items in the door trays.

- ※ Protect fresh food you want to freeze using aluminum foil, cling film, air and water tight

- plastic bags, polyethylene containers or other suitable plastic containers with a lid.
- ※ Leave some free space between the single pieces of frozen food as proper air circulation is required.
 - ※ The food is frozen completely after 24 hours (you find the relevant information about the *maximum freezing capacity within 24 hours* in chapter TECHNICAL DATA).
 - ※ Only buy frozen food, when its packaging is not damaged. Damaged packaging may indicate an interruption of the cold chain.
 - ※ Avoid or reduce variations in temperature: buy frozen food at the end of shopping and transport it in thermally insulated bags.
 - ※ Do not refreeze defrosted and semi-defrosted food. Consume within 24 hours.
 - ※ Observe the complete information on the packaging of frozen food.

Environmental protection

Energy saving





- ※ Install the appliance in a dry and well-ventilated place.
- ※ Install the appliance in a suitable position with an adequate distance from sources of heat and cold.
- ※ Protect the appliance from direct sunlight.
- ※ Do not line the drawers with aluminum foil, waxed paper or paper layers; otherwise optimum circulation of the cold air is impeded so the appliance cannot work at best performance.
- ※ Cooked food can be stored in the appliance. Let it cool down to room temperature before you put it into your appliance.
- ※ Store your food in colorless, airtight and tasteless materials.
- ※ Some food like meat, fish etc. may become dry and release strong odors. You can avoid these by wrapping them into aluminum foil or plastic wrap or putting them into an airtight bag or container.
- ※ Allow ample storage place for your food. Do not overfill your appliance.
- ※ Wrap your food in plastic wrap or suitable paper and place each kind of food in a particular location in your appliance. This will prevent any contamination, a loss of water and a mingling of odors.
- ※ Let warm or hot food cool down to room temperature before you put it into your appliance. Otherwise the energy consumption will increase and encrusted ice will be generated.
- ※ If you buy frozen food, the packaging must not be damaged and the product must be properly stored (sales container -18°C or lower).
- ※ Put the frozen food you want to defrost into the cooling-compartment of your appliance.
- ※ How to defrost frozen food depends on your kitchen-equipment and the purpose, you want to use the frozen food for.
 - √ Room temperature
 - √ in the cooling-compartment of your appliance
 - √ in an electrical oven (Regard the corresponding functions of your oven)
 - √ in a microwave (Regard the corresponding functions of your microwave)
- ※ Try opening the door as little as possible, especially when the weather is warm and humid. If you open the door, close it as fast as possible.

- ※ Permanently check, that the appliance is well-ventilated. The appliance has to be well-ventilated from all sides.
- ※ Defrost the appliance periodically as encrusted ice will decrease the power and increase the energy consumption of the appliance.
- ※ 355 kWh per year based on standard test results for 24 hours. Actual energy consumption will depend on how the appliance is used and where it is located.

Meaning of the *-labeling of freezers

 1- (*), 2- (**), and 3-stars (***) freezers **are not suitable for freezing fresh food.**

 2-stars (**) and 3-stars (***) freezers are suitable for storing frozen food (**pre-frozen**) and ice or for making ice and ice cubes.

COMPARTMENTS	STARS (*)	TARGET STORAGE TEMPERATURE	SUITABLE FOOD
FREEZER	(***)*	≤ -18°C(-0.4°F)	>Suitable for seafood (fish, shrimps, shellfish), freshwater and meat products. >Recommended storage period: 3 months  Suitable for freezing fresh food.
FREEZER	***	≤ -18°C(-0.4°F)	>Suitable for seafood (fish, shrimps, shellfish), freshwater and meat products. >Recommended storage period: 3 months  <u>Not</u> Suitable for freezing fresh food.
FREEZER	**	≤ -12°C(10.4°F)	>Suitable for seafood (fish, shrimps, shellfish), freshwater and meat products. >Recommended storage period: 2 months  <u>Not</u> Suitable for freezing fresh food.
FREEZER	*	≤ -6°C(21.2°F)	>Suitable for seafood (fish, shrimps, shellfish), freshwater and meat products. >Recommended storage period: 1 months  <u>Not</u> Suitable for freezing fresh food.
0* - COMPARTMENT	-	-6°C(21.2°F) – 0 °C(32°F)	>Suitable for fresh meat products (pork, beef, chicken, etc.) and processed food consumed or processed within the same day or within the next three days after storage (max.).  <u>Not</u> suitable for freezing food or for storing frozen food.

Storage of food

Your appliance has the accessories as the “Description of the appliance” showed in general, with this part instruction you can have the right way to storage your food.

Food is not allowed to touch directly all surfaces inside the appliance. It has to be wrapped separately in aluminum sheet or in cellophane sheet or in airtight plastic boxes.

Store food in refrigerator compartment.

The fridge freezer compartment helps to extend the storage times of fresh perishable foods.

Fresh food care for best results:

Store foods that are very fresh and of good quality.

Ensure that food is well wrapped or covered before it is stored. This will prevent food from dehydrating, deteriorating in color or losing taste and will help maintain freshness. It will also prevent odor transfer. Vegetables and fruit need not be wrapped if they are stored in the vegetable container of the fridge compartment.

Make sure that strong smelling foods are wrapped or covered and stored away from foods such as butter, milk and cream which can be tainted by strong odors.

Cool hot foods down before placing them in the fridge compartment.

Dairy foods and eggs

Most pre-packed dairy foods have a recommended ‘use by /best before/best by/ date stamped on them. Store them in the fridge compartment and use within the recommended time.

Butter can become tainted by strong smelling foods so it is best stored in a sealed container.

Eggs should be stored in the fridge compartment.

Red meat

Place fresh red meat on a plate and loosely cover with waxed paper, plastic wrap or foil.

Store cooked and raw meat with separate plates. This will prevent any juice lost from the raw meat from contaminating the cooked product.

Poultry

Fresh whole birds should be rinsed inside and out with cold running water, dried and placed on a plate. Cover loosely with plastic wrap or foil.

Poultry pieces should also be stored this way. Whole poultry should never be stuffed until just before cooking, otherwise food poisoning may result.

Fish and seafood

Whole fish and fillets should be used on the day of purchase. Until required, refrigerate on a plate loosely covered with plastic wrap, waxed paper or foil.

If storing overnight or longer, take particular care to select very fresh fish. Whole fish should be rinsed in cold water to remove loose scales and dirt and then patted dry with paper towels.

Place whole fish or fillets in a sealed plastic bag.

Keep shellfish chilled at all times. Use within 1 – 2 days.

Precooked foods and leftovers

These food should be stored in suitable covered containers so that the food will not dry out.

Keep for only 1-2 days.

Reheat leftovers only once and until steaming hot.

Vegetable container

The vegetable container is the optimum storage location for fresh fruit and vegetables.

Take care not to store the following at temperatures of less than 7°C (44.6°F) for long periods:

Citrus fruit, melons, aborigines, pineapple, papaya, curette, passion fruit, cucumber, peppers, tomatoes.

Undesirable changes will occur at low temperatures such as softening of the flesh, browning and/or accelerated decaying.

Do not refrigerate avocados (until they are ripe), bananas and mangoes.

Freezing and storing food in the freezer compartment

To store deep-frozen food.

To make ice cubes.

To freeze food.

Note: Ensure that the freezer compartment door has been closed properly.

Purchasing frozen food

Packaging must not be damaged.

Use by the 'use by /best before/best by/' date.

If possible, transport deep-frozen food in an insulated bag and place quickly in the freezer compartment.

Storing frozen food

Store at -18°C or colder. Avoid opening the freezer compartment door unnecessarily.

Freezing fresh food

Freeze fresh and undamaged food only.

To retain the best possible nutritional value, flavor and color, vegetables should be blanched before freezing. Aborigines, peppers, zucchini and asparagus do not require blanching.

Note: Keep food to be frozen away from food which is already frozen.

The following foods are suitable for freezing:

Cakes and pastries, fish and seafood, meat, game, poultry, vegetables, fruit, herbs, eggs without shells, dairy products such as cheese and butter, ready meals and leftovers such as soups, stews, cooked meat and fish, potato dishes, and desserts.

The following foods are not suitable for freezing:

Types of vegetables, which are usually consumed raw, such as lettuce or radishes, eggs in shells, grapes, whole apples, pears and peaches, hard-boiled eggs, yogurt, soured milk, sour cream, and

mayonnaise.

Packing frozen food

To prevent food from losing its flavor or drying out, place food in airtight packaging.

1. Place food in packaging.
2. Remove air.
3. Seal the wrapping.
4. Label packaging with contents and dates of freezing.

Suitable packaging:

Plastic film, tubular film made of polyethylene, aluminum foil. These products are available from specialist outlets.

Recommended storage times of frozen food in the freezer compartment

These times vary depending on the type of food. The food that you freeze can be preserved from 1 to 12 months (minimum at -18°C(-0.4°F))

Food	Storage time
Bacon, casseroles, milk	1 month
Bread, ice cream, sausages, pies, prepared shellfish, oily fish	2 month
Non-oily fish, shellfish, pizza, scones and muffins	3 month
Ham, cakes, biscuits, beef and lamb chops, poultry pieces	4 month
Butter, vegetables (blanched), eggs whole and yolks, cooked crayfish, minced meat (raw), pork (raw)	6 month
Fruit (dry or in syrup), egg whites, beef (raw), whole chicken, lamb (raw), fruit cakes	12 month

Never forget:

When you freeze fresh foods with a 'use by /best before/best by/' date, you must freeze them before this date expires.

Check that the food was not already frozen. Indeed, frozen food that has thawed completely must not be refrozen.

Once defrosted, food should be consumed quickly.

Operational parameters

1. The appliance can only reach the relevant temperatures when:
 - a. the ambient temperature meets the climatic class.
 - b. the doors close properly.
 - c. you do not open the doors too often or too long.
 - d. the door seals are in proper condition.
 - e. the appliance is properly-positioned.
 - f. you have not overfilled the appliance.
 - g. you do not store warm or hot food in the appliance.
2. The 4 star**** freezing compartment freezes food at a temperature of -18°C (-0.4°F) or lower. The freezing temperature is affected by the room temperature, site and frequency of door

operation.

3. The freezing temperature should not be warmer than -18°C (-0.4°F).
4. When the ambient temperature is very high, it is recommended to set the thermostat to a colder setting if needed. If the colder setting should cause strong formation of encrusted ice, please select a lower setting.
5. High ambient temperatures and simultaneously operating at the coldest setting may make the compressor operate permanently to keep the temperature constant inside the appliance.
6. Defrost the appliance periodically as encrusted ice will decrease the power and increase the energy consumption of the appliance.

Cleaning and maintenance

 **DANGER!** Never touch the power plug, the power switch or other electrical components with wet or damp hands. **RISK OF ELECTRIC SHOCK!**

 **WARNING!** Disconnect the appliance from the mains before you clean or maintain it. **RISK OF ELECTRIC SHOCK!**

 **WARNING!** To disconnect the appliance from the mains, you must unplug the appliance or use a cut-off device.

 **WARNING!** Remove possible dust accumulation at the power plug, at the safety power socket and at all plug connectors **regularly**. **RISK OF FIRE!**

NOTICE! Clean the appliance **at least** once a month.

1. Always keep the appliance clean so that unpleasant odors do not occur.
2. Dust deposits on the condenser will increase the energy consumption. Clean the condenser twice a year with a vacuum cleaner or a soft brush.
3. Take off all rings and bracelets before cleaning or maintaining the appliance; otherwise you will damage the surface of the appliance.

DETERGENT:

>Do not use any harsh, abrasive or aggressive detergents.

>Do not use any solvents.

>Do not use any abrasive detergents!

>Do not use any organic detergents! (Detergents such as vinegar, citric acid etc)

>Do not use essential oils!

>These instructions are valid for all surfaces of your appliance.

EXTERNAL CLEANING:

1. Use a moist cloth and a mild, non-acidic detergent. Use a suitable detergent for stubborn stains.
2. Use clear water to rinse.
3. Dry the cleaned surfaces with a cloth.

INTERNAL CLEANING:

1. Clean the shelves and the inside with warm water and a mild detergent.
2. Use clear water to rinse.
3. Dry the cleaned surfaces with a cloth.
4. Check the water drain and clean it if needed.

DOOR SEALS:

>Clean with warm water and a mild, non- acidic detergent. Do not restart the appliance until the door seals have dried completely.

DRAIN HOLE (depending on model):

>Clean the drain hole at the back of the cooling compartment periodically; otherwise defrost water can get into the cooling compartment. Use a suitable device such as a pipe cleaner.

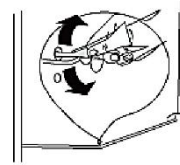

NOTICE! Empty and clean the drip tray regularly!

Defrosting

COOLING COMPARTMENT

>The cooling-compartment is defrosted automatically

FREEZER COMPARTMENT

>The freezer is defrosted automatically.

FREEZER Optional procedure if encrusted ice should have occurred:

⚠ WARNING! Switch off the appliance by turning the thermostat (depending on model) to position 0 / AUS / OFF **and** disconnect it from the mains

⚠ WARNING! To disconnect the appliance from the mains, you must unplug the appliance or use a cut-off device.

⚠ WARNING! Never use any mechanical items, knives or other sharp-edged objects to remove the encrusted ice. Never use a steam cleaner. **RISK OF ELECTRICAL SHOCK!**

⚠ WARNING! Do not use hairdryers, electrical heaters or other technical devices to accelerate the defrosting-progress. **RISK OF ELECTRICAL SHOCK!**

1. Remove the contents from the fridge and put them into a cooling box.
2. Switch off the appliance by **disconnecting it from the mains or use a cut-off device.**
3. Place a container in front of the appliance to catch the water.
4. When the encrusted ice melts put some dry cloths into the freezer compartment to hold the water back.
5. **Do not** use hot water to accelerate the defrosting operation.
6. Remove the big pieces of ice first.
7. Afterwards remove the small pieces of ice.
8. Wipe and dry the appliance and door seals with dry and soft cloths.

9. After cleaning leave the door open for some time to ventilate the appliance.

Replacing of the illuminate

 **WARNING!** The LED-illuminate must be replaced by a competent person only. If the LED-illuminate is damaged, please contact a qualified professional.

Replacing of the power cord

 **DANGER!** The power cord must be replaced by a qualified and authorized professional only.

Trouble shooting

 **WARNING!** Before you start troubleshooting, disconnect the appliance from the mains. Any work not described in this instruction manual must be carried out by a qualified professional only.

MALFUNCTION

POSSIBLE CAUSE	MEASURE
THE APPLIANCE DOES NOT WORK AT ALL	
<ol style="list-style-type: none"> 1. The plug of the appliance is not connected to the socket. 2. The plug has become loose. 3. The socket is not supplied with energy. 4. The fuse is switched off 5. The voltage is too low. 	<ol style="list-style-type: none"> 1. Connect the appliance to the mains properly. 2. Check the plug. 3. Check the corresponding socket by connecting it with another appliance. 4. Check the fuse box 5. Compare the data on the model plate with the data of your energy supplier.
THE COMPRESSOR DOES NOT WORK AT ALL	
<ol style="list-style-type: none"> 1. Incorrect energy supply. 	<ol style="list-style-type: none"> 1. Check the energy supply.
THE COMPRESSOR OPERATES FOR TOO LONG.	
<ol style="list-style-type: none"> 1. The appliance has been switched off for a while. 2. Too much or too hot food in the appliance 3. Doors opened too often or too long. 	<ol style="list-style-type: none"> 1. The appliance needs some time to reach the preset temperature. 2. Remove any hot food. 3. Do not open the door too often/too long.
FORMATION OF ENCRUSTED ICE.	
<ol style="list-style-type: none"> 1. The air outlets may be blocked by food. 2. The door is not properly closed. 3. The door seal is damaged or soiled. 	<ol style="list-style-type: none"> 1. Store the food in another place. 2. Close the door properly. 3. Clean and / or replace the door seal.
THE DOOR MAKES A STRANGE SOUND WHEN OPENED.	
<ol style="list-style-type: none"> 1. The door seals are soiled. 	<ol style="list-style-type: none"> 1. Clean the door seals.
UNCOMMON NOISE.	
<ol style="list-style-type: none"> 1. The appliance is not installed on a flat and level ground. The appliance 	<ol style="list-style-type: none"> 1. Install the appliance properly. 2. Store food properly.

<p>touches a wall or another object.</p> <p>2. Frozen food is stored improperly.</p> <p>3. Items have dropped behind the appliance.</p>	<p>3. Remove the items.</p>
WATER DRIPS ON THE FLOOR	
<p>1. The water pan (located at the rear bottom of the cabinet) may not be properly leveled, or the draining spout (located underneath the top of the compressor depot) may not be properly positioned to direct water into this pan, or the water spout is blocked.</p>	<p>1. You may need to pull the refrigerator away from the wall to check the pan and spout.</p>
THE LIGHT IS NOT WORKING	
<p>1. The LED light may be damaged.</p> <p>2. The control system has disabled the lights due to the door being kept open too long.</p>	<p>1. Refer to replace LED lights in cleaning and care chapter.</p> <p>2. Close and reopen the door to reactivate the lights.</p>

 If the appliance shows a malfunction not the same as the list above or if you have checked all items on the above schedule but the problem still exists, please contact the shop you purchased the appliance at.

 <p>THE OPERATING CONDITIONS DESCRIBED BELOW ARE NORMAL AND DO NOT INDICATE A MALFUNCTION.</p>
<p>※The refrigerant generates a sound similar to flowing water.</p> <p>※Sometimes you may hear a sound which is generated by the injection process of the cooling circuit.</p> <p>※The sides of the appliance may get warm while the appliance is running.</p>
DISTINCT NOISE
<p>When you operate the appliance for the first time or the temperature falls below a certain level, the appliance will operate with high power to reach the preset temperature.</p>
CONDENSED WATER IN / ON THE APPLIANCE
<p>It may be generated inside or outside the appliance by high humidity or very warm ambient temperatures.</p>
CLICKING
<p>You will hear the compressor click if it is activated or deactivated.</p>
HUM
<p>It is caused by the compressor while running.</p>
KNOCKING / SNAPPING
<p>It may be generated by sequential expansion and shrinkage of the components of the cooling system. It is caused by variation of temperature before and after the compressor is activated or deactivated</p>

Decommissioning

DECOMMISSIONING, TEMPORARILY:

IF THE APPLIANCE IS NOT USED FOR A LONGER PERIOD OF TIME:

1. Disconnect the appliance from the mains. To disconnect the appliance from the mains, you **must** unplug the appliance or use a cut-off device.
2. Remove all food stored in the appliance.
3. Dry the inside of the appliance with a cloth and leave the door open for a few days.

WHILE AWAY ON AN AVERAGE VACATION / HOLIDAY (14-21 DAYS):

1. Do the same as described above, or
2. let the appliance operate.
 - a. remove all perishable food from the cooling compartment.
 - b. clean the cooling compartment.
 - c. freeze all food which is suitable to be frozen.

IF YOU WANT TO MOVE THE APPLIANCE:

1. Secure all removable parts and the contents of the appliance. Pack them separately if necessary.
2. Transport the appliance in an upright position only. All other positions can cause damage to the compressor.
3. Do not damage the feet of the appliance.

DECOMMISSIONING, ULTIMATE:

1. Disconnect the appliance from the mains. To disconnect the appliance from the mains, you **must** unplug the appliance or use a cut-off device.
2. Cut off the power cord at the appliance.
3. Completely remove every door of the appliance.
4. Leave the shelves in their position so that children are not able to get into the appliance.
5. Follow the advice for the disposal of the appliance in chapter WASTE MANAGEMENT.

Technical data

Technical data*

Model	Freezer-Fridge
Energy efficiency class**	DOE
Annual energy consumption in kW/h***	528
Voltage / frequency	115V AC/60 Hz
Volume gross in Cu. Ft.	18.9
Net volume fridge / freezer in Cu. Ft.	12.35/6.53
Adjustable thermostat	yes
Compressor	yes
Refrigerant / total quantity	R600a / 65 g
Display	yes
Control lamps: operation / fast freezing / warning light	Yes/yes/yes
Key lock / child protection	yes
Internal light: fridge	yes
Internal light: freezer	yes
Adjustable feet	Yes, 2 in front
Defrosting cooling comp. / freezer	automatically / automatically

Waste management

1. Dispose of the appliance relevant to the current legislation in view of explosive gases. The cooling systems and insulation of refrigerators and freezers contain refrigerants and gases which have to be disposed of properly. Do not damage the cooling fins and tubes. **If refrigerants escape there is FIRE HAZARD!**
2. While unpacking, the packaging materials (polythene bags, polystyrene pieces, etc.) should be kept away from children and pets. **CHOKING HAZARD! RISK OF INJURY!**
3. Old and unused appliances must be sent for disposal to the responsible recycling center. Never expose to open flames.
4. Before you dispose of an old appliance, **render it inoperative**. Unplug the appliance and cut off the entire power cord. Dispose of the power cord and the plug immediately. **Remove the door completely** so children are not able to get into the appliance as this endangers their lives!
5. Dispose of any paper and cardboard into the corresponding containers.
6. Dispose of any plastics into the corresponding containers.
7. If suitable containers are not available at your residential area, dispose of these materials at a suitable municipal collection point for waste-recycling.
8. Receive more detailed information from your retailer or your municipal facilities.

REFRIGERANT:

1. The refrigerant circuit of the appliance contains the refrigerant R600a, a natural gas of high environmental compatibility.
2. **⚠️ WARNING!** Do not damage any components of the refrigerant circuit while transporting the appliance. FIRE HAZARD!



Materials marked with this symbol are recyclable.



Please contact your local authorities to receive further information.



The refrigerant R600a is flammable!

Wire Diagram

