



**Ducted Self-Contained
Wine Cellar Cooling Systems
Installation, Operation and Maintenance Manual
60Hz Models: D025, D050, D088, D200
50Hz Models: WG40, WG75, WG100, WG175**



Manufactured by



AIR INNOVATIONS

Syracuse, NY

wineguardian.com

airinnovations.com

Wine Guardian reserves the right, without notice, to make changes to this document at its sole discretion.

Please visit our web site for the most current version of the Wine Guardian manual and other literature.

Wine Guardian is a registered trademark (2,972,262) of Air Innovations, Inc.

Edition 12/2021 (Original Instructions)

© Air Innovations 2021

Part No. 15H0325-00

Table of Contents

Safety	5
Lockout/Tagout Procedure.....	6
Safety Warnings	6
Receiving, Inspecting and Unpacking.....	6
Directory of terms	7
General Overview.....	8
Accessories/Options.....	11
Component Overview	12
Wiring Diagrams.....	15
Dimensions/Specifications.....	19
Installation	23
Pre-Installation.....	23
Pre-Installation Planning.....	23
Reducing Noise Generation	24
Ductwork	24
Duct Collar and Panel Adjustment	26
Drain Line.....	27
Wiring to Power	27
Installing the Remote Interface and Communication Cable	29
Additional Remote Interface.....	30
Controller Specification.....	30
Mounting the Remote Interface Controller (Wired).....	31
Mounting the Remote Interface Controller (Wireless).....	32
Installation of the Wine Guardian Remote Sensor	33
Mounting the Remote Sensor (Wired)	33
Mounting the Remote Sensor (Wireless).....	35
Remote Sensor Pairing – Multiple Sensors (Wireless).....	36
Remote Interface Functions	37
Alarm Codes.....	44
Start-Up.....	46
Maintenance	47
Flushing the Water Regulating Valve – Water-Cooled Only	48

Cleaning the Humidifier (Optional)	48
Maintenance Schedule	48
Monthly	48
Yearly	48
Troubleshooting	49
Resetting the High-Pressure Switch	49
Contact and Warranty	51
Contact Information	52
Warranty	52

Note: This equipment has been tested and found to comply with the limits for a Class B digital device, pursuant to part 15 of the FCC Rules. These limits are designed to provide reasonable protection against harmful interference in a residential installation. This equipment generates, uses and can radiate radio frequency energy and, if not installed and used in accordance with the instructions, may cause harmful interference to radio communications. However, there is no guarantee that interference will not occur in a particular installation. If this equipment does cause harmful interference to radio or television reception, which can be determined by turning the equipment off and on, the user is encouraged to try to correct the interference by one or more of the following measures:

- Reorient or relocate the receiving antenna.
- Increase the separation between the equipment and receiver.
- Connect the equipment into an outlet on a circuit different from that to which the receiver is connected.
- Consult the dealer or an experienced radio/TV technician for help. RSS GEN (English)

This device contains license-exempt transmitter(s)/receiver(s) that comply with Innovation, Science and Economic Development Canada's license-exempt

RSS(s). Operation is subject to the following two conditions:

1. This device may not cause interference.
2. This device must accept any interference, including interference that may cause undesired operation of the device.

RSS GEN (French)

L'émetteur/récepteur exempt de licence contenu dans le présent appareil est conforme aux CNR d'Innovation, Sciences et Développement économique Canada applicables aux appareils radio exempts de licence. L'exploitation est autorisée aux deux conditions suivantes:

1. L'appareil ne doit pas produire de brouillage;
2. L'appareil doit accepter tout brouillage radioélectrique subi, même si le brouillage est susceptible d'en compromettre le fonctionnement.

Safety

The safety messages contained in this manual are highlighted in red bolded and for quick identification. A Danger message indicates an imminently hazardous situation which, if not avoided, can result in death or serious injury. Messages identified by the word DANGER are used sparingly and only for those situations presenting the most serious hazards. The following is a typical example of a Danger message as it could appear in the manual.



HIGH VOLTAGE - RISK OF SERIOUS INJURY OR DEATH

High voltages are present in the cabinets.

Before opening panels turn off all power.

Use the Lockout/Tagout procedure.

The equipment covered by this manual is designed for safe and reliable operation when installed and operated within its designed specifications. To avoid personal injury or damage to equipment or property when installing or operating this equipment, it is essential that qualified, experienced personnel perform these functions, using good judgment and safe practices. See the following cautionary statements. Installation and maintenance of this equipment is to be performed only by qualified personnel who are familiar with local codes and regulations and are experienced with this type of equipment.

Exposure to safety hazards is limited to maintenance personnel working in and around the unit. When performing maintenance, always use the Lockout/Tagout procedure, which is described in this chapter. Observe the maintenance safety guidelines in the Wine Guardian Manual.

Electrical Hazards - Working on the equipment may involve exposure to dangerously high voltage. Make sure you are aware of the level of electrical hazard when working on the system. Observe all electrical warning labels on the unit. There are no electrical safety lockouts installed within the unit. The power cord attached to the control box must be disconnected from the power sources prior to working on any part of the electrical system.

Hot Parts Hazards Electric -Electric heaters may start automatically, disconnect all power and control circuits prior to servicing the unit to avoid burns.

Moving Parts Hazards - The motor can start automatically. Disconnect all power and control circuits prior to servicing to avoid serious injuries or possible dismemberment. Be sure to use the Lockout/Tagout procedure when working on these units.

Lockout/Tagout Procedure

1. Turn off the power switch (indicator light should be off).
2. Unplug the unit from the electrical outlet and cover the outlet to prevent accidentally plugging in the unit.

Safety Warnings

- Never reach into a unit while the fan is running.
- Disconnect all power sources before working on the unit.
- Check weights to be sure the rigging equipment can support and move the Wine Guardian unit safely. **Note:** any specific rigging and installation instructions located in the [Installation section](#) of the Wine Guardian Manual.
- Do not remove access panels until fan impellers have completely stopped. Pressure developed by moving impellers can cause excessive force against the access panels.
- Never pressurize equipment above specified test pressure (~300 psi).
- Always ground the outlet to provide adequate protection against voltage surges and built-up static charges.
- Refer all servicing to qualified service personnel. Servicing is required when the unit has been damaged in any way.
- Do not use extension cords.
- Do not modify the equipment; it may cause damage to the equipment and will void the warranty.

Receiving, Inspecting and Unpacking

When receiving the unit, ensure the unit is undamaged and includes all ordered accessories.

Note: Wine Guardian units are factory assembled and tested prior to shipment. Wine Guardian units are shipped in individual corrugated boxes.

- ✓ Lift at the designated handhold locations only or fully support from underneath. A shipment may include one or more boxes containing accessories.
- ✓ Before opening the container, inspect the packing crates or boxes for obvious signs of damage or mishandling.
- ✓ Write any discrepancy or visual damage on the bill of lading before signing.
- ✓ Inspect all equipment for any sign of damage caused during transit.
- ✓ Report all visual or concealed damage to the carrier and file a claim immediately.
- ✓ Thoroughly inspect the contents for any visible damage or loose parts.

IMPORTANT

If this procedure is not followed, the shipping company may reject the claim and the consignee may suffer the loss. Do not return the shipment to the factory.

Review the Packing Slip to verify the following:

- ✓ Model #
- ✓ Factory Installed Options
- ✓ Unit Accessories

If any items listed on the packing slip do not match your order information, contact the place of purchase immediately.

Check the unit for these items:

- ✓ An Electrical Power Cord connected to unit
- ✓ A Remote Interface with 50' of communications cable
- ✓ 7' of Clear Plastic Drain Hose
- ✓ Quick Start Guide
- ✓ Remote Interface Operation Guide
- ✓ Remote Interface Mounting Template

Directory of terms

- **Ambient Air** – The surrounding area outside the cellar such as a room, basement, garage or outdoors.
- **CFM** – Cubic feet per minute. A unit of measurement for the amount of air handled by the fan.
- **Condensate / Condensation** – The water formed out of the air when it is cooled below a certain temperature (called dew point). Often referred to as “sweating” on pipes and cold surfaces. This water collects at the bottom of the evaporator or cooling coil and drains out of the unit through the drain line.
- **Condenser (Heat Rejection) Section / Coil** – The Condenser Section uses the compressor, condenser coil and fan to remove heat from the refrigerant to the ambient air outside the wine cellar. The word condenser refers to the condensation of the refrigerant from gas to liquid phase.
- **CE** – Certificate of European conformity
- **CSA/ETL** – Canadian Standard Association/Electric Testing Laboratory
- **Exhaust Air** – The air leaving the evaporator or condenser section of the Wine Guardian unit.
- **Evaporator (Cooling) Section / Coil** – The Evaporator Section uses the cooling coil and the fan to remove heat from the air inside the wine cellar to the refrigerant, cooling the air and condensing moisture out of the air. The word evaporator refers to the evaporation of the refrigerant from liquid to gas phase in the coil. The Evaporator Section is connected to or inside the wine cellar.
- **Flexible Duct** – Round ducts with steel reinforced plastic liners, a layer of insulation and an outer plastic layer used to convey the air from the unit to the cellar or ambient space.
- **Grille or Diffuser** – Inlet or outlet plates to direct the airflow or protect the inside of the unit.

- **Heat Gain / Loss** – The amount of cooling or heating expressed in watts transferred between the wine cellar and the ambient space. The Wine Guardian must offset this load.
- **Inlet Air** – The air entering the evaporator and condenser sections of the Wine Guardian unit.
- **I.D.** – Inside diameter
- **O.D.** – Outside diameter
- **NEC** – National Electrical Code.
- **Psig Pounds** – Force per square inch gauge
- **Recovery** – The amount of cooling the unit does to return the cellar to its set point temperature after some new load is introduced, such as people or new cases of warm wine entering the cellar.
- **Return Air** - The air leaving the cellar and returning to the inlet of the evaporator coil.
- **SP** – Static pressure. Unit of measurement (inches of water column) of the pressure of the air handled by the fan.
- **Set Point** – The desired temperature or humidity set on the thermostat or humidistat.
- **Supply Air** - The air entering the cellar from the discharge of the evaporator coil.

General Overview

The Wine Guardian cooling unit is a professional grade, American manufactured, self-contained climate control unit designed specifically for the storage of wine at cellar temperatures. It is designed for easy installation and operation. Wine Guardian uses digital electronic controls and R-134a refrigerant. The entire unit is tested at the factory and shipped as a single package. All components are of a high quality, standard commercial grade. The entire unit is approved by ETL according to UL 1995 and CSA safety standards. All wiring complies with NEC. Each unit is furnished with a sealed, UL-approved power cord and plug. All Wine Guardian 50Hz units carry the CE mark. Each unit is furnished with a sealed, CE-approved power cord and plug.

The Wine Guardian wine cellar cooling systems are completely self-contained and includes either an integral air cooled or water-cooled condenser. The units are functionally divided into two sections, the evaporator (or cooling section) and the condenser (or heat rejection section). Each section contains a coil to add or remove heat and a fan to move the air through the coil and into or out of the cellar or adjacent space. The Wine Guardian cooling systems are designed to be used as a remotely mounted unit with external ductwork connections.

Air first passes through the cooling coil and is cooled by the refrigerant inside the coil. This causes any excess humidity in the air to condense and be captured in the drain pan and piped outside the unit. Air then enters the fan where it is pressurized and discharged out of the unit. Optional heating coils are located between the cooling coil and the fan. These coils heat the air to prevent low temperatures in the cellar. The thermostat, located in the cellar, turns on the cooling (or optional heating) as needed to

maintain its setpoint. It does not allow the cooling and heating to be on at the same time.

The compressor and condenser sections are activated whenever the unit is cooling. The condenser fan draws air from the surrounding or ambient space either directly or through a duct. The air is first drawn through a filter to remove any airborne dust particles to keep the coil clean. The air flows through the condenser coil where it absorbs heat from the refrigerant in the coil. The air is then discharged out of the unit by the condenser fan. The air exhaust from the condenser fan on air-cooled units is hot and will be 25 to 35 ° F (15 – 18 ° C) above the entering temperature. This may cause overheating problems in the summer months, especially with high humidity. Exhaust the hot air to the outside or to a space that is a minimum of 3x larger than the wine room. In cold weather, this heated air can help to heat the surrounding space.

The water-cooled Wine Guardian system requires cooling water to be piped to the unit for proper operation. The cooling water absorbs the refrigerant heat through the unit's water-cooled condenser coil. Warm water is then directed out of the unit back to the cooling water system. We do not recommend using a water-cooled system if you are using a city water supply.

Each Ducted Self-Contained Wine Guardian system Contains:

- ✓ A thermal expansion valve to control the flow of refrigerant into the evaporator coil
- ✓ A Filter Drier
- ✓ A manual reset high pressure switch to protect the system from high pressures
- ✓ Refrigeration Service Ports for connection of gauges
- ✓ A built-in condensate drain trap. (**Do not install an external trap**)

The Wine Guardian 60Hz models meet or exceed their rated capacities for total BTU/H and CFM at design cellar conditions and external static pressures. The Wine Guardian 50Hz models meet or exceed their rated capacities for total watts and cubic liters per second at design cellar conditions and external static pressures. Both the evaporator and condenser fans are capable of rated CFM against the external static pressure imposed by recommended ductwork. Both fans are motorized impeller plug fans, statically and dynamically balanced, and use permanently lubricated, direct drive motors that require no maintenance.

All exterior framing of the Wine Guardian is powder coated aluminum to prevent rust and corrosion. All evaporator coils are aluminum tubes and aluminum fins with a protective anti-corrosion coating. The unit uses an external drain to remove excess moisture and not reintroduce it into the cellar or ambient space. Removable, multiple access doors are provided to facilitate cleaning and maintenance, duct connections, and access to components and wiring. The condenser coils have pre-filters on the inlet to prevent dust and dirt from fouling the coils, thereby reducing capacity. Each unit has at least three discharge outlets on both the evaporator and the condenser coils to facilitate custom installations. Water-cooled units have copper straight tube connections for both cooling water inlet and outlet.

Each unit is provided with a pre-wired and tested electronic digital thermostat for remote mounting in the cellar. The thermostat has multiple control functions for the fans, cooling, and heating. It has a fully automatic mode to switch between heating and cooling (for units configured with a heater). Compressors are rotary, self-lubricating, permanently sealed, hermetic reciprocating type compressors, with internal overload protection and capacitor start with a minimum of one-year service and two-year parts manufacturer's warranty and an optional five-year compressor warranty. Compressors are mounted on rubber-in-shear isolators to reduce noise and vibration. Electric power is supplied by a single, factory-furnished cord and plug. All external controls are digital and proprietary to Wine Guardian products. Only the approved communication cable and Wine Guardian controllers are suitable for proper system operation.

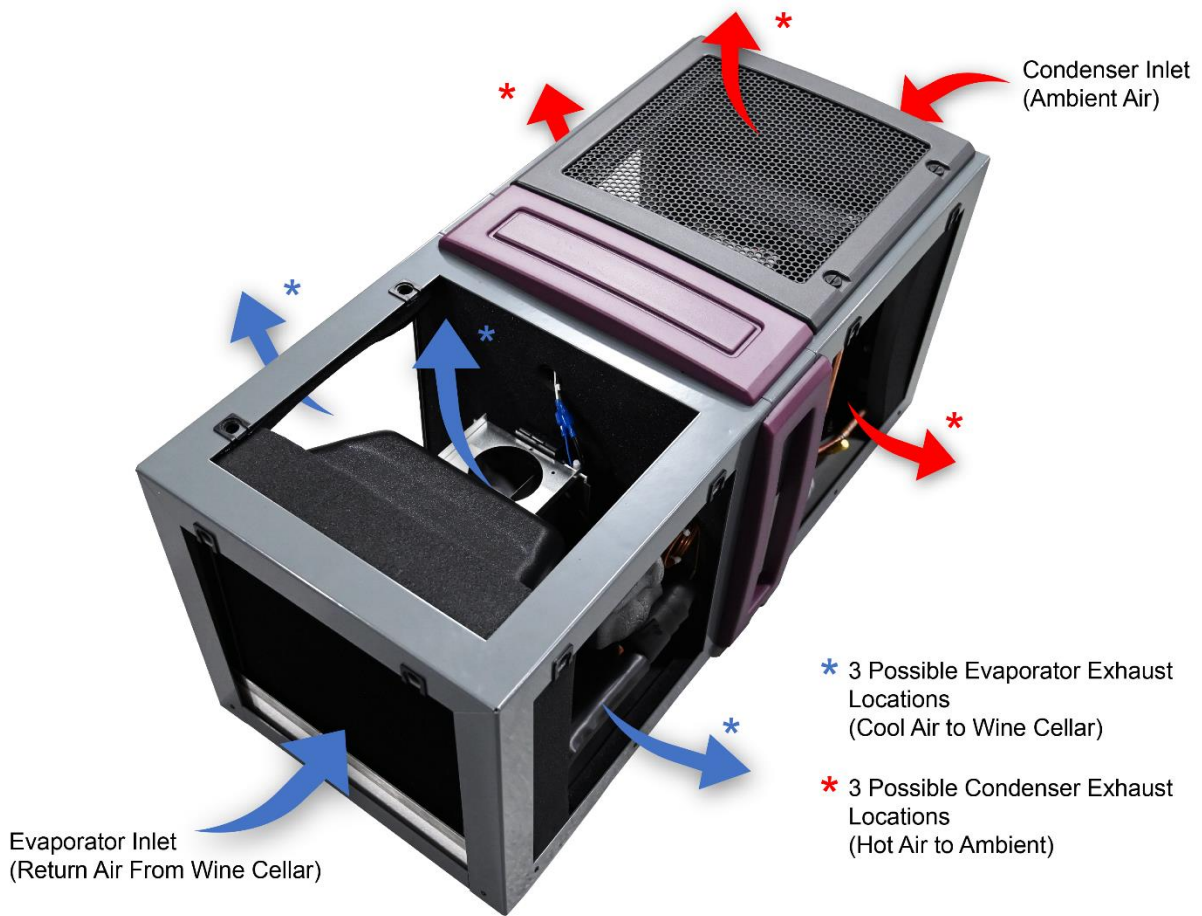

Accessories/Options

All Wine Temperatures (AWT) (available for both air-cooled and water-cooled systems)

A serving temperature defrost sensor and electric heating element are installed during production. The electric heating option is factory installed and includes primary and secondary over-temperature protection devices per UL and NEC.

Extreme Climate Protection (only available with air-cooled systems)

This bundle includes both a factory installed Low Ambient, a factory installed High Ambient upgrade, and a Anti-Corrosion Coating for the Condenser Coil to protect against salt air and other corrosive environments. The Low Ambient feature makes the Wine Guardian capable of exposure to low ambient temperatures. This feature controls the condenser fan operation based on head pressure and heats the oil reservoir, as well including a 3 Row Condenser Coil. This bundle is recommended whenever the system will experience condenser inlet temperatures below 40 °F (4 °C) or above 100 °F (37 °C) to protect the system and allow it to continue to operate at extreme temperatures. This bundle will protect the system from temperatures as low as 20 °F (-6.7 °C) and as high as 115 °F (46 °C).

Ultimate Bundle (only available with air-cooled systems)

This bundle includes everything from both the All Wine Temperatures bundle and the Extreme Climate Protection bundle.

Humidifier and Humidistat

Another popular option for the Wine Guardian ducted self-contained unit is a humidifier. The humidifier is available as a freestanding unit powered by the Wine Guardian system with its own power cord and humidistat or as an integrated unit, which bolts to the side of any Wine Guardian ducted system. The Wine Guardian humidifier requires a water supply and drain for operation. Please refer to the Humidifier Manual for Installation Instructions.

Duct Collar Kits

Ducting for the Wine Guardian is sold in kits by size for each unit. Each kit contains two adapter collars, one 25' (7.3 meters) length of round flexible duct and two straps. The number of duct kits needed depends on the layout. The size of the kit depends on the model Wine Guardian selected. Follow installation instructions carefully. Poorly or incorrectly installed ducts can degrade the performance of your unit dramatically.

Extended Compressor Warranty

The Wine Guardian uses only the best commercially available compressors on the market. However, since the compressor is the single most expensive component in the unit, it is recommended that you purchase the extended warranty option.

Component Overview

Cabinet – The cabinet (outer housing) is constructed of aluminum with a powder-coated finish for corrosion protection.

Condensing Section – Ambient air is circulated through the condenser section by a direct drive, permanently lubricated, motorized impeller blower. This section also contains the compressor and the electrical controls. If the water-cooled option is purchased, a heat exchanger is used in place of the condenser coil and blower.

Evaporator Section – Cellar air is circulated through the evaporator section by another blower, similar to the condensing section. The large evaporator-coil face area eliminates condensate carry-over, reduces air pressure drop and optimizes heat transfer. A drain pan is located directly below the coil to capture condensate and is fabricated from aluminum to prevent rust and corrosion. The electric heating coil, if ordered, is factory installed between the evaporator coil and the blower and is complete with contactors and limit controls.

Electrical Controls – Most of the electrical components and controls are in a separate area accessible on the side of the unit. All wiring is in accordance with the NEC. Wires are numbered and color coded to match the wiring diagrams.

Filters – A nominal 1-inch-thick (25-mm-thick) filter is provided on the condenser inlet to protect the coils from dust and dirt. This filter is washable and reusable.

Internal Drain Trap - Water condensate from the evaporator coil fills the trap and forms a seal to prevent air from being drawn back through the drain tube. This allows the drain pan to drain freely. **No external trap is required.**

Supply/Return Duct Collar – Two duct collars are provided with the unit – one for the inlet and another for the outlet of the evaporator section. Every duct collar is interchangeable with the access doors, allowing you to control and direct the airflow. Each single-direction duct collar is made of composite material. These duct collars can be removed via the two quarter-turn screws.

Supply grille – A composite-material, single-direction grille is provided on the outlet of condenser section. One grille is provided on an outlet. The grille is interchangeable with access doors, allowing you to control and direct the airflow.

Removable Panels – Insulated, removable, composite-material panels are provided on both the evaporator and condenser of the unit. These panels can be removed via the two quarter-turn screws

AIR-COOLED

Fig. 1

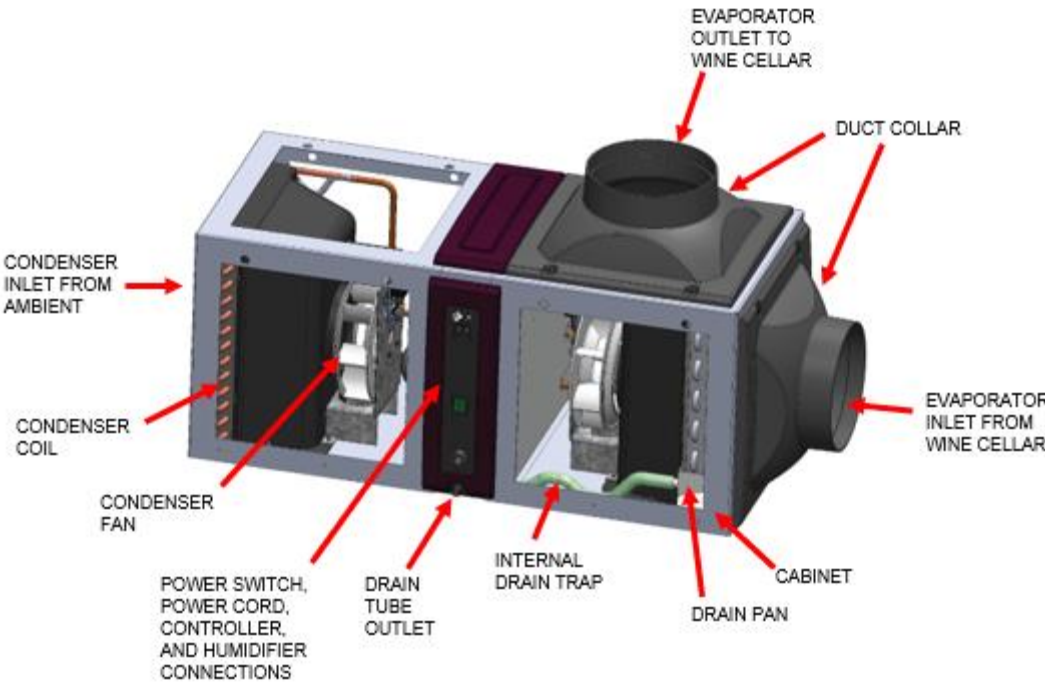
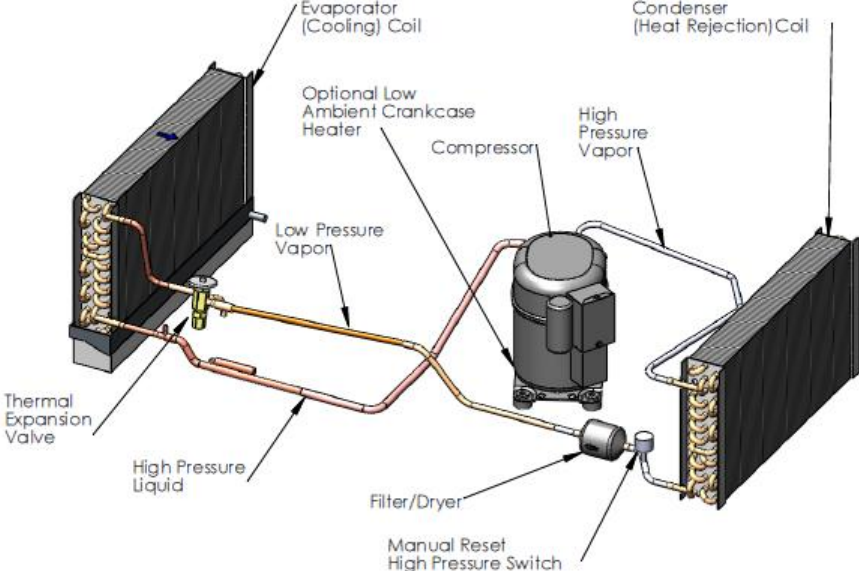

Fig. 2

Overview Illustration - Vapor Compression System



WATER-COOLED

Fig. 3

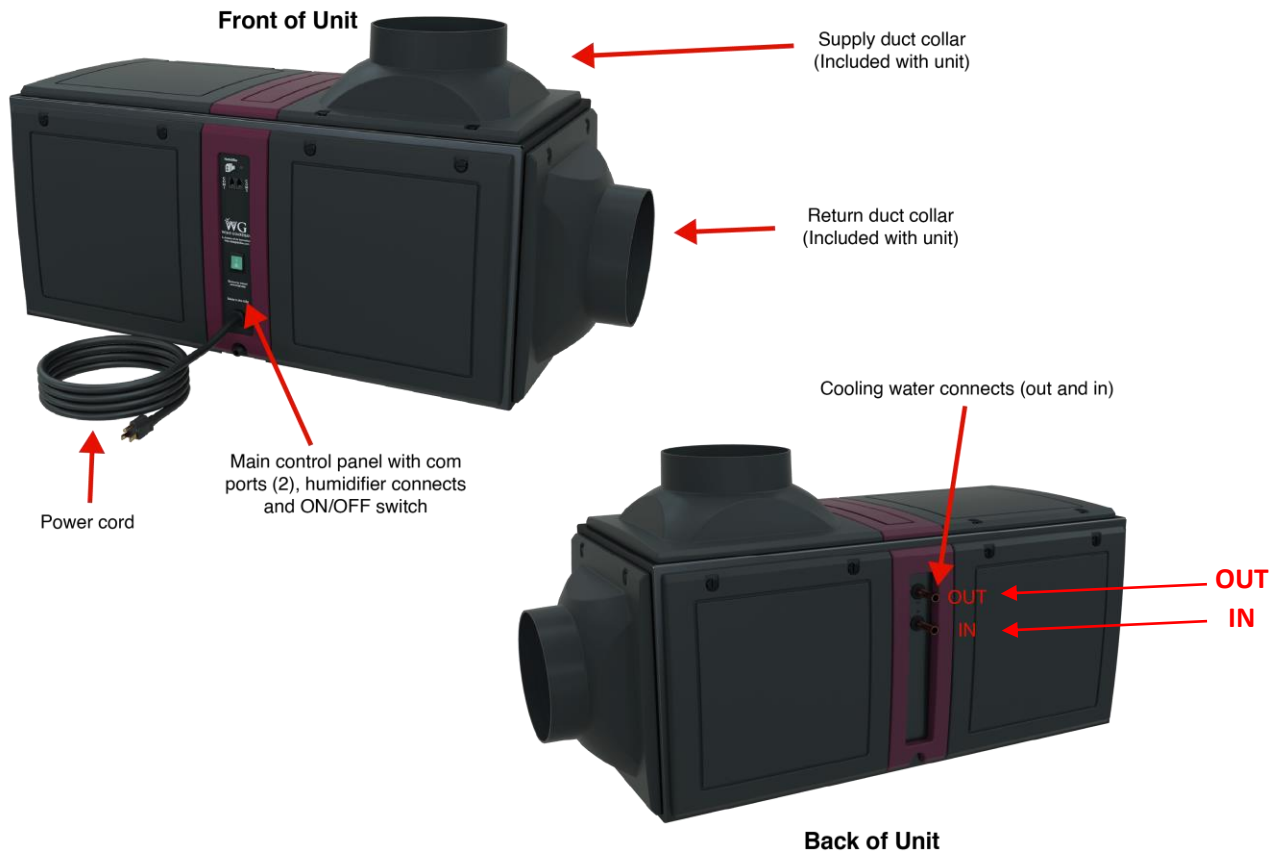
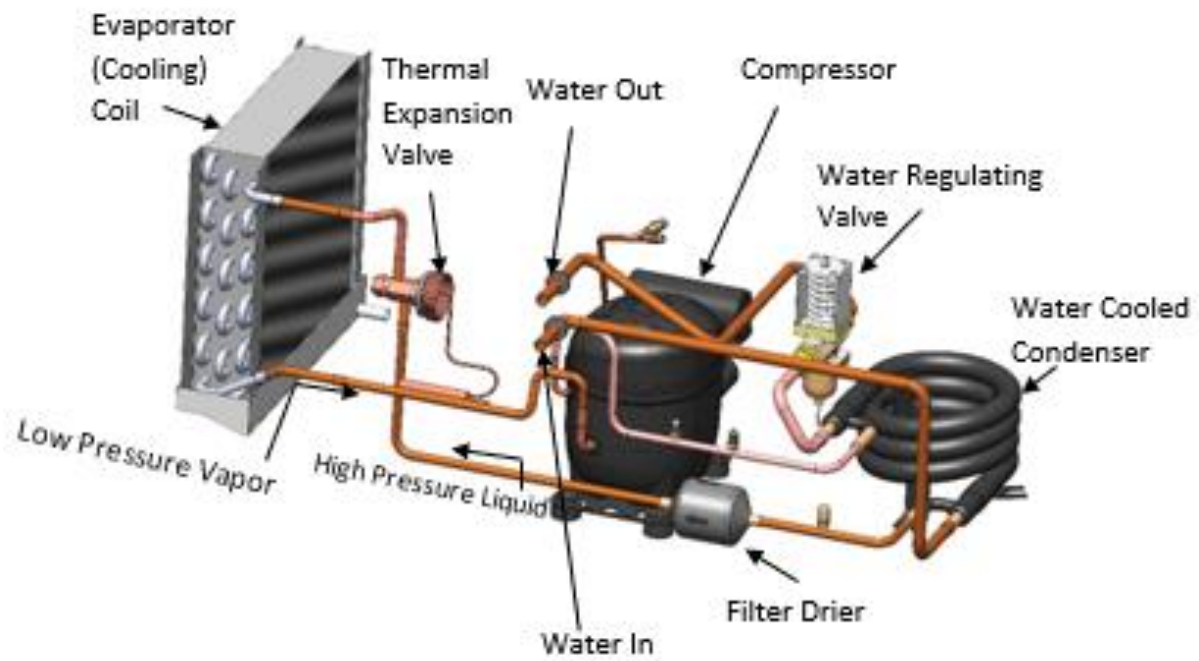
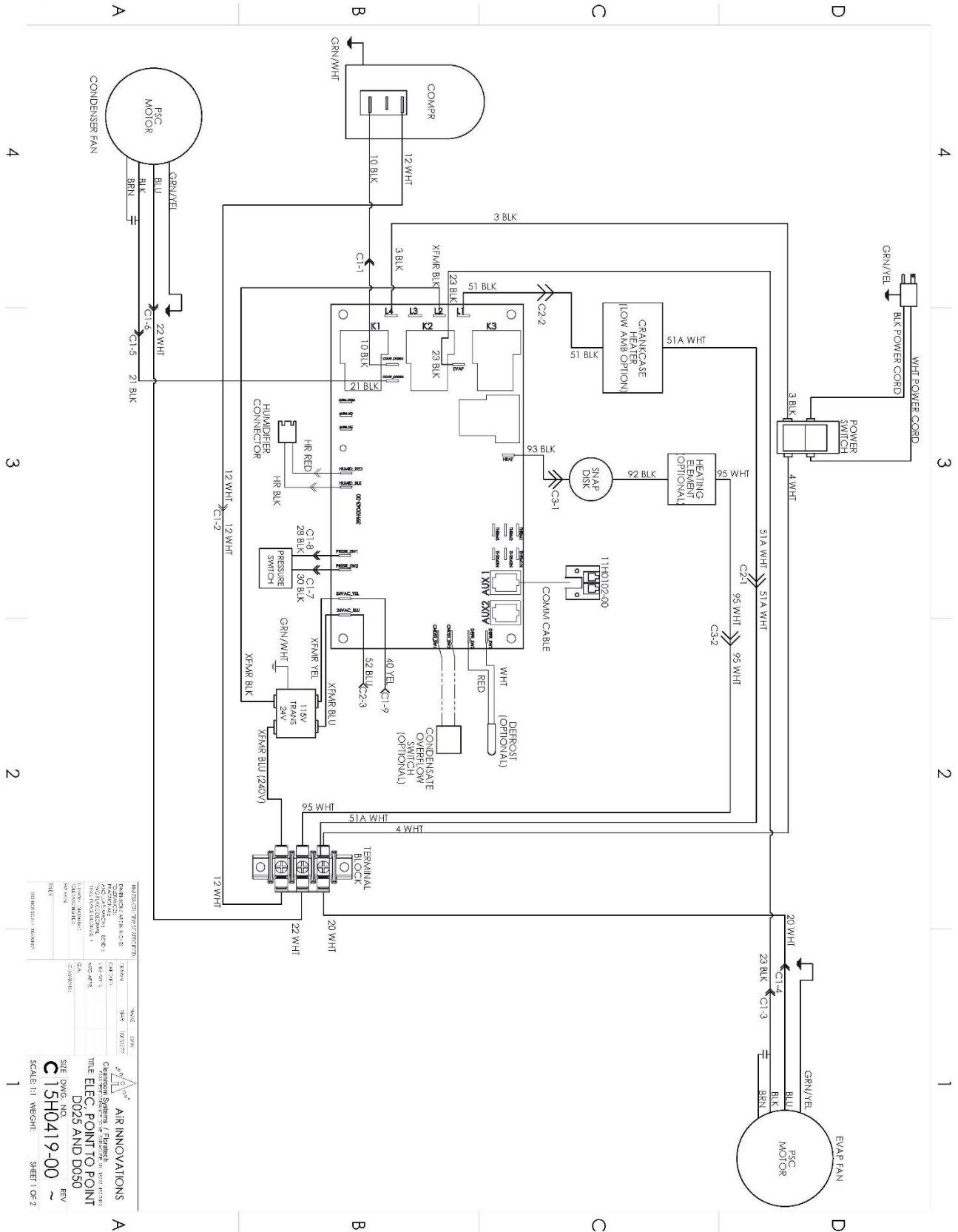

Fig. 4



Wiring Diagrams

Fig. 5 (D025, D050, WG40, WG75, WG100)



REVISIONS	DATE	BY	REASON
1	10/13/20
2
3
4

AIR INNOVATIONS
 CHARLESTON SYSTEMS & EQUIPMENT
 1115 W. 24th Ave.
 Charleston, SC 29405
 TEL: 803.733.1111
 FAX: 803.733.1112
 WWW: www.airinnovations.com

ELEC POINT TO POINT
 D025 AND D050
 SCALE: 1:1 WEIGHT: SHEET 1 OF 2

Fig. 7 (D025, D050, WG40, WG75, WG100)

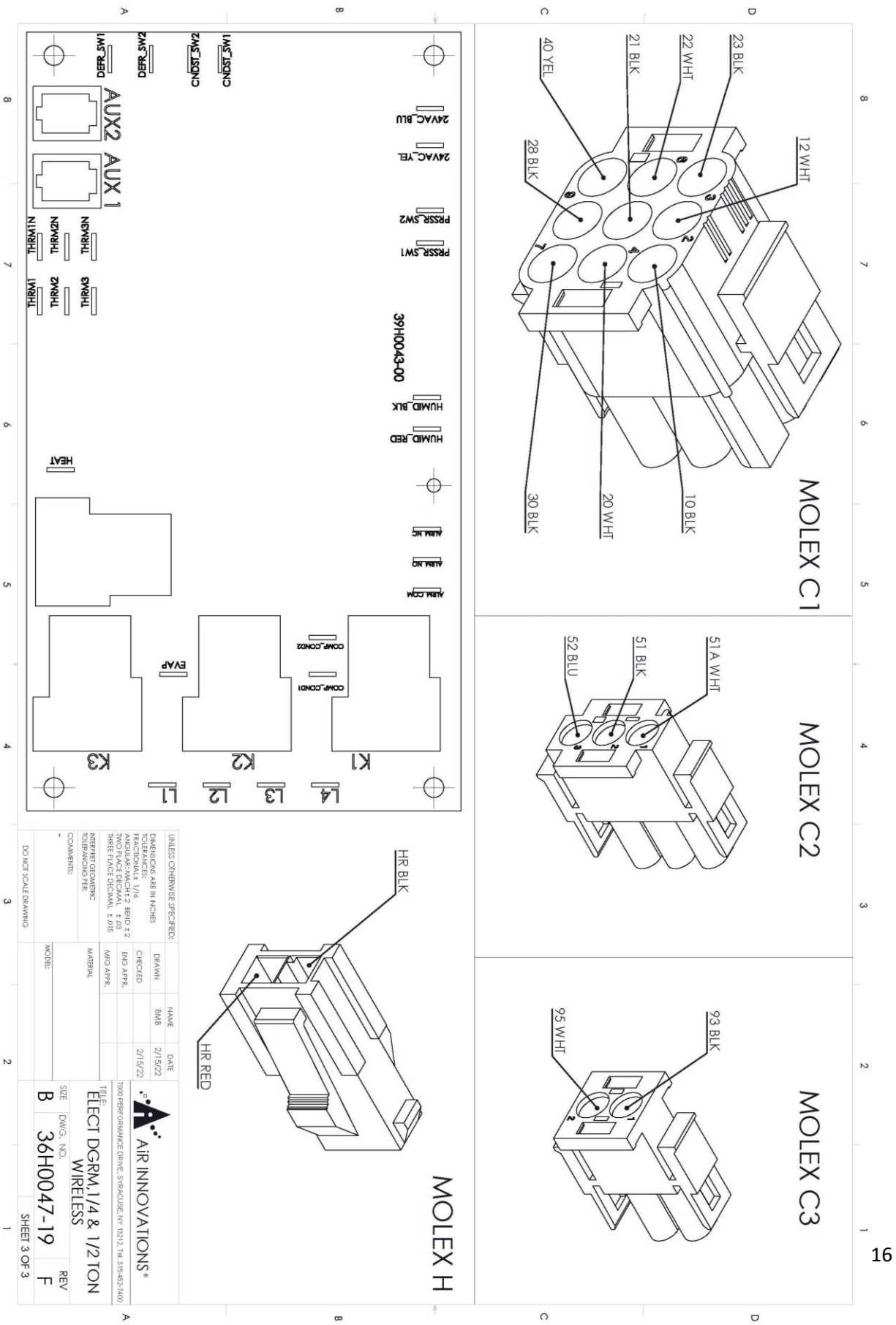
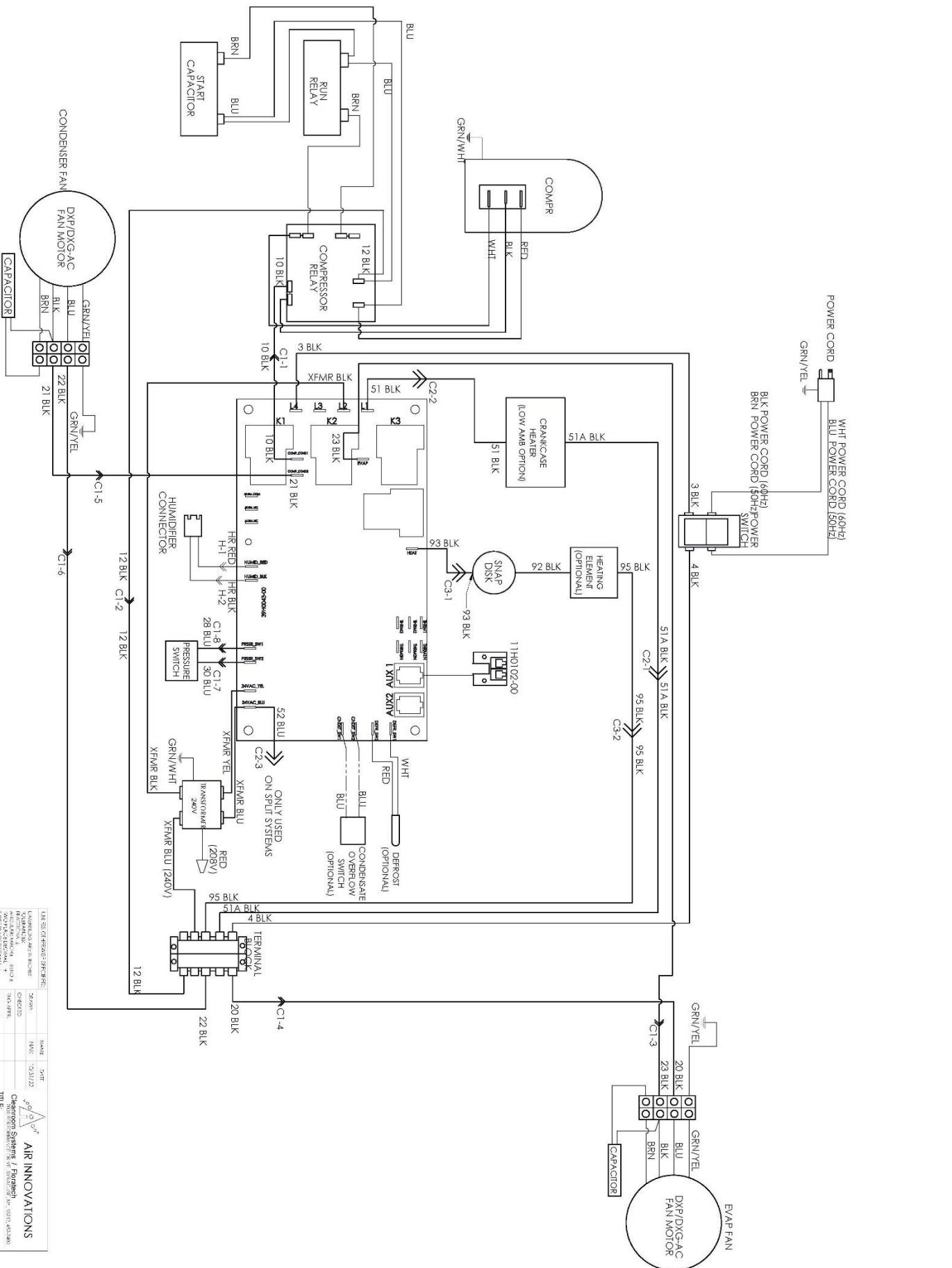
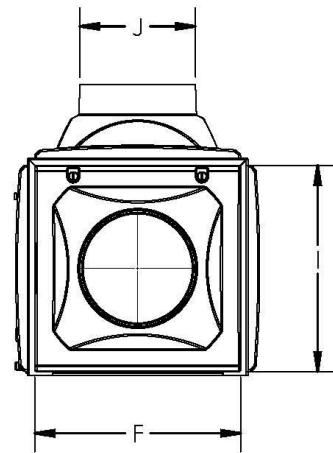
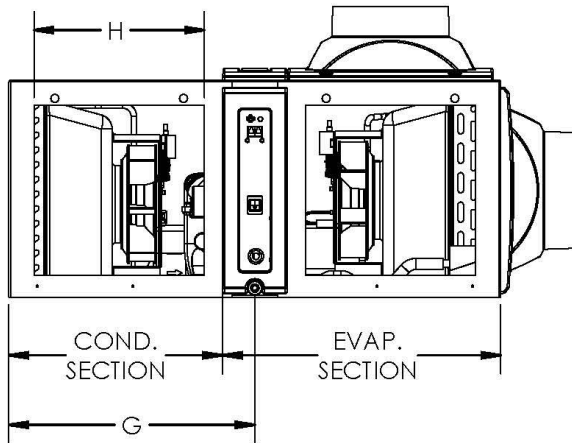
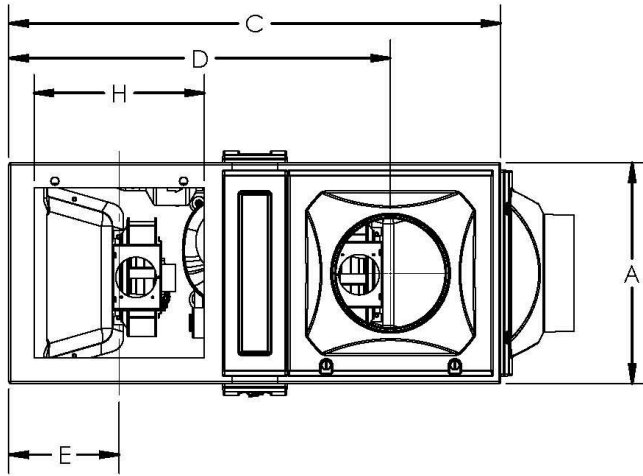

Fig. 8 (D088)



THE USE OF DIMENSIONS (INCHES): DIMENSIONS ARE IN INCHES DIMENSIONS ARE IN MILLIMETERS DIMENSIONS ARE IN METERS DIMENSIONS ARE IN FEET DIMENSIONS ARE IN METERS DIMENSIONS ARE IN FEET DIMENSIONS ARE IN METERS DIMENSIONS ARE IN FEET	
COMPANY: AIR INNOVATIONS PROJECT: CHARLOTTE SHOPS / FINNEN TITLE: ELEC. POINT TO POINT, D088 SCALE: 1/11 SHEET: 1 OF 2	DATE: 10/31/22 DRAWN: JACOB CHECKED: JACOB APPROVED: JACOB PROJECT MANAGER: JACOB PROJECT ENGINEER: JACOB PROJECT ARCHITECT: JACOB PROJECT INTERIOR ARCHITECT: JACOB PROJECT EXTERIOR ARCHITECT: JACOB PROJECT MECHANICAL ENGINEER: JACOB PROJECT ELECTRICAL ENGINEER: JACOB PROJECT PLUMBING ENGINEER: JACOB PROJECT HVAC ENGINEER: JACOB PROJECT FIRE ENGINEER: JACOB PROJECT SAFETY ENGINEER: JACOB PROJECT GENERAL CONTRACTOR: JACOB PROJECT OWNER: JACOB

Dimensions/Specifications



Dimensional Data for 60Hz Models

Chassis Type		Chassis A	Chassis B
Model Number		D025	D050 / D088 / D200
Dimensions - Nominal - add 0.375 inches for each grille			
A – Depth	Inches	16.6	22.4
B – Height	Inches	15.56	18.85
C – Width	Inches	33.45	41.5
D – Evap. discharge location	Inches	26.19	32
E – Cond. discharge location	Inches	7.26	10.33
F – Inlet opening width	Inches	14.52	15.55
G – Drain outlet location	Inches	16.73	20.75
H – Discharge opening width	Inches	14.52	14
I – Inlet opening Height	Inches	14.52	15.8
J – Duct opening	Inches	8	10
AA – Water out (O.D)	Inches	0.50	0.5
BB – Water in (O.D)	Inches	0.50	0.5
Weight	lbs.	80	125 / 125 / 206

Dimensional Data for 50Hz Models

Chassis Type		Chassis A	Chassis B
Model Number		WG40	WG75 / WG100 / WG175
Dimensions - Nominal - add 9.5mm for each grille			
A - Width	mm	422	569
B - Height	mm	395	479
C - Length	mm	850	1054
D – Evap. discharge	mm	665	813
E – Cond. discharge	mm	185	262
F - Inlet opening width	mm	369	395
G - Drain outlet location	mm	425	527
H - Discharge opening width	mm	369	355
I - Inlet opening Height	mm	369	401
Weight	kg	36.3	56.7 / 56.7 / 93.4

Specifications

Wine Guardian Specification Sheet – 60Hz models

SPECIFICATIONS						Sentinel Series	
Ducted Cooling Units							
Model Number		D025 (R134A)	D050 (R134A)	D088 (R134A)		D200 (R134A)	
Power Requirements	volt/phase/hz	115/1/60	115/1/60	208/1/60	230/1/60	208/1/60	230/1/60
Performance							
Net Cooling Capacity*		Total/Sensible	Total/Sensible	Total/Sensible	Total/Sensible	Total/Sensible	Total/Sensible
@60 Deg F condenser inlet air	BTUH	4520/3050	6920/4920	10700/7120	10830/7500	17570/12430	17680/12790
@70 Deg F condenser inlet air	BTUH	4300/2915	6570/4740	9900/6800	10250/7160	16580/11650	16720/12000
@80 Deg F condenser inlet air	BTUH	3760/2715	6320/4510	9420/6610	9600/6850	15350/11100	15680/11780
@90 Deg F condenser inlet air	BTUH	3540/2580	5860/4230	8600/6120	8760/6210	14000/10580	15000/10870
@110 Deg F condenser inlet air	BTUH	3260/2400	4865/3820	N/A	N/A	N/A	N/A
@120 Deg F condenser inlet air	BTUH	3000/2260	4585/3590	N/A	N/A	N/A	N/A
Controls							
Type		Digital electronic	Digital electronic	Digital electronic		Digital electronic	
Temperature Accuracy/RH% Accuracy		1F / 10%	1F / 10%	1F / 10%		1F / 10%	
Evaporator Section							
Fan Motor Size	Watts	75	100	175	195	160	180
Rated Air Flow (free blow)	CFM	245	390	435	485	760	810
Rated Air Flow @ pressure loss	CFM	200 @0.10" wc	320 @0.20" wc	370 @0.20" wc	440 @0.20" wc	710 @0.35" wc	745 @0.35" wc
Air-cooled Condenser Section							
Fan Motor Size	Watts	75	100	175	195	160	180
Rated Air Flow (free blow)	CFM	245	390	435	485	760	810
Rated Air Flow @ pressure loss	CFM	200 @0.10" wc	320 @0.20" wc	370 @0.20" wc	440 @0.20" wc	700 @0.35" wc	745 @0.35" wc
Water-cooled Condenser Section (option)							
Water usage at 20 Deg F rise	GPM	0.50	0.60	1.20		2.50	
Pressure drop	PSI	0.20	0.40	0.08		1.20	
Pipe connection size (in/out) O.D.	Inches	0.50	0.50	0.50		0.63	
Heat (Option)							
Type		Electric	Electric	Electric	Electric	Electric	Electric
Capacity	Watt/BTUH	1000/3400	1000/3400	1635/5582	2000/6800	1635/5582	2000/6800
Humidifier (Option)							
Type		Removable drip pad with integral fan					
Capacity - water temp of 60 Deg F	lbs./hr	0.42					
Capacity - water temp of 90 Deg F	lbs./hr	0.97					
Capacity - water temp of 100 Deg F	lbs./hr	1.11					
Electrical Requirements							
Current Draw - Cooling mode	Amps	7.1	11.3	9.8	8.8	15.6	14.1
Current Draw - Heating mode	Amps	9.4	9.6	8.8	9.5	8.8	9.5
Minimum Circuit amps (heat / no heat)	Amps	11.6/8.6	11.8/13.7	10.7/11.8	11.7/10.6	10.7/19.1	11.7/17.2
Optional Low Ambient	Amps	0.4	0.4	0.2	0.2	0.2	0.2
Optional High Ambient	Amps	0.2	0	N/A	N/A	N/A	N/A
Optional Humidifier	Amps	0.4	0.4	0.4	0.4	0.4	0.4
Cabinet							
Construction		Aluminum chassis & UL Rated plastic panels					
Finish		Gray Metal epoxy powder coat/textured PVC Acrylic blend					
Weight	lbs.	78	125	125		206	
Dimensions (inches)	Width	33.45	41.5	41.5		41.5	
	Depth	16.6	22.4	22.4		22.4	
	Height	15.56	18.85	18.85		18.85	
Condensate Drain connection (ID)	inches	.50"	.50"	.50"		.50"	
Minimum Ductwork Size	Inches	8	10	10		12	
Agency approval	ETLc	UL 1995 / CSA C22.2					
1. Net cooling capacity at entering temperature and humidity conditions of 57 Deg F and 55% RH at rated airflow. Reduce capacity by 3% for each 10% reduction in evaporator airflow.							
2. Wine Guardian reserves the right to make changes to this document without prior notice at its sole discretion.							
3. All rating at sea level.							
<p>Wine Guardian Factory & Headquarters: 7000 Performance Drive North Syracuse, New York 13212 USA Wine Guardian European Office: Pestalozzistrasse 2, CH-8201 Schaffhausen, Switzerland help.wineguardian.com info@wineguardian.com Wine Guardian® is a registered trademark of Air Innovations</p>							

Wine Guardian Specification Sheet – 50Hz models

SPECIFICATIONS		 Sentinel Series				
Ducted Cooling Units						
Model Number		D025 (R134A)	WG40 (R513A)	WG75 (R134A)	WG100 (R134A)	WG175 (R134A)
Power Requirements	volt/phase/hz	240/1/50	240/1/50	240/1/50	240/1/50	240/1/50
Performance						
Net Cooling Capacity*		Total/Sensible	Total/Sensible	Total/Sensible	Total/Sensible	Total/Sensible
@21 Deg C condenser inlet air	Watts	916/850	935/755	1525 / 1381	2197 / 1801	4399 / 3589
@27 Deg C condenser inlet air	Watts	858/831	940/760	1421 / 1323	2059 / 1711	4121 / 3432
@32 Deg C condenser inlet air	Watts	791/791	890/735	1316 / 1263	1946 / 1666	3835 / 3276
Controls						
Type		Digital electronic				
Temperature Accuracy/RH% Accuracy		1F / 10%				
Evaporator Section						
Fan Motor Size	Watts	75	75	100	195	240
Rated Air Flow (free blow)	M3/H	451	451	706	808	1051
Rated Air Flow @ pressure loss (8 meter flex duct)	M3/H	400	400	635	727	946
Air-cooled Condenser Section						
Fan Motor Size	Watts	75	75	100	195	240
Rated Air Flow (free blow)	M3/H	451	451	748	850	1105
Rated Air Flow @ pressure loss (8 meter flex duct)	M3/H	400	400	673	765	995
Water-cooled Condenser Section (option)						
Water usage at 11 Deg C rise	L/sec	0.03	0.03	0.04	0.08	0.16
Pressure drop	kPa	1.38	1.38	2.76	5.50	8.27
Pipe connection size (In/Out) outside diameter	mm	12.70	12.70	12.70	12.70	15.00
Heat (Option)						
Type		Electric	Electric	Electric	Electric	Electric
Capacity / temp rise (including fan)	Watts	1000 / 7.5	1000 / 7.5	1000 / 5	2000 / 6.7	2000 / 4.5
Humidifier (Option)						
Type		Removable drip pad with integral fan				
Capacity - water temp of 16 Deg C	L/Day	6.00				
Capacity - water temp of 32 Deg C	L/Day	13.20				
Capacity - water temp of 49 Deg C	L/Day	19.30				
Electrical Requirements						
Current Draw - Cooling mode	Amps	4.8	4.8	4.9	9.5	14.2
Current Draw - Heating mode	Amps	4.4	4.4	4.4	8.7	8.7
Minimum Circuit amps (heat / no heat)	Amps	15	15	15	15	15
Optional Low Ambient	Amps	0.4	0.4	0.4	0.2	0.2
Optional Humidifier	Amps	0.3	0.3	0.3	0.2	0.2
Cabinet						
Construction		Aluminum chassis & UL Rated plastic panels				
Finish		Gray Metal epoxy powder coat/textured PVC Acrylic blend				
Weight	kg	35.38	35.38	56.7	56.7	93.44
Dimensions (cm)	Length	85	85	100	100	100
	Depth	42.2	42.2	57	57	57
	Height	39.5	39.5	48	48	48
Condensate Drain connection (ID)	cm	1.27	1.27	1.27	1.27	1.27
Minimum Ductwork Size	Millimeters	203.2	203.2	254	254	254
Agency approval	ETLc	UL 1995 / CSA C22.2				

1. Net cooling capacity at entering temperature and humidity conditions of 57 Deg F and 55% RH at rated airflow. Reduce capacity by 3% for each 10% reduction in evaporator airflow.

2. Wine Guardian reserves the right to make changes to this document without prior notice at its sole discretion.

3. All rating at sea level.

Wine Guardian Factory & Headquarters:
7000 Performance Drive | North Syracuse, New York 13212 USA

Wine Guardian European Office:
Pestalozzistrasse 2, CH-8201 Schaffhausen, Switzerland
help.wineguardian.com | info@wineguardian.com

Wine Guardian® is a registered trademark of Air Innovations

Installation

For questions or help regarding installation, call customer service at 1-315-452-7400 or email info@wineguardian.com a sketch of the proposed area where the unit is to be installed.

Pre-Installation

Test the system before installing it to check for non-visible shipping damage.

- ✓ Set the system on the floor or a sturdy level surface.
- ✓ Plug in the system.
- ✓ Press the on/off switch and check that the control illuminates. This indicates the system has power.
- ✓ The built-in timer prevents short cycling and keeps the compressor from turning on right away.



**RISK OF PERSONAL INJURY OR DAMAGE TO EQUIPMENT
SHARP EDGES ARE PRESENT INSIDE THE WINE GUARDIAN SYSTEM**

Pre-Installation Planning

Prior to installation determine how best to mount the unit. Please ensure a 3' minimum clearance for service work.

Floor Mounting - Mount the Wine Guardian fan coil on the floor but elevate it 4" (10cm) as a minimum on a frame with a plywood surface to keep it away from water. Allow adequate space for the external drain.

Fig. 1

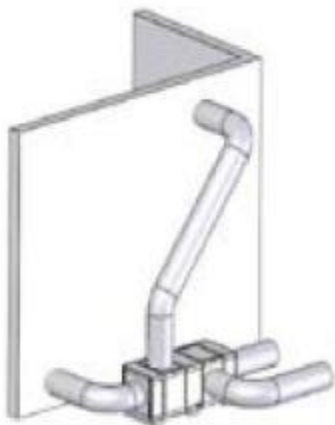

Wall Mounting - If the unit is to be surface mounted on the wall, adequately support it on both sides of the wall. Use floor or knee braces to transfer the load of the unit to the floor or wall.

Ceiling Mounting - Construct a structurally sound, level platform to place the unit on when hanging it from the ceiling joists. The Wine Guardian system is NOT designed to be suspended from the top of the unit; it must be supported from the bottom. Place the unit on a platform to ensure that the unit is supported on all four corners. Leave adequate space on the top of the unit to remove the access doors for service.

Fig. 2

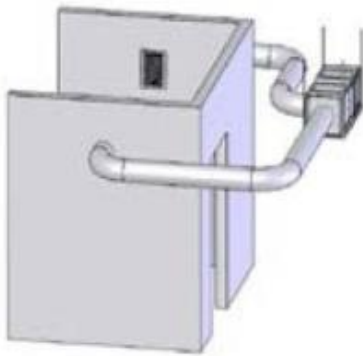

In all cases, the unit must be level to within $\pm 0.25''$ ($\pm 6.35\text{mm}$) end-to-end and $\pm 1/8''$ ($\pm 3.18\text{mm}$) side-to-side for proper operation. Locate the unit as close to the wine cellar as possible to reduce the length of the duct runs. If possible, use straight ducting on all duct runs.

Reducing Noise Generation

Consider noise when locating the unit close to the cellar or to an adjacent occupied space. The addition of $0.25''$ (6.35mm) thick rubber pads under the unit will help prevent the transmission of vibration and noise. A piece of $1''$ or $2''$ (25 or 50mm) noise dampener between the unit and the wall absorbs and reduces the noise from the unit. For air noise reduction, use flexible ductwork to absorb the noise. Sound usually travels as a line of sight. Sound is reduced when it turns a corner, such as passing through a bend in ductwork. If the unit is supported from a wall or joist, using a rubber pad under the unit will reduce vibration transmission.

Ductwork

Wine Guardian units are typically installed indoors near the wine cellar to minimize the duct runs. Each unit is provided with one entering or return air inlet and three possible supply air outlets for each of the evaporator and condenser sections. A maximum cumulative total length for both supply and return ducts (including bends) of 25ft (7.5m) is recommended. If longer runs are needed, examine your duct run using our [Ductwork Calculator](#)

Use ductwork to connect the unit to the supply and return outlets in the wine cellar. Use only insulated ductwork to minimize cooling losses, prevent sweating, and to reduce noise.

Use ductwork on the condenser section to redirect or absorb sound, to bring in outside air to the unit inlet, and/or to exhaust the hot air out of the ambient space.

Ductwork Diameters (inches) – Wine Guardian 60 Hz units		
Model #	Evaporator (cold air side) Condenser (hot air side)	
	Single Duct Run	Double Duct Run
D025	8	6
D050/D088/D200	10	8
Ductwork Diameters (millimeters) – Wine Guardian 50 Hz units		
Model #	Evaporator (cold air side) Condenser (hot air side)	
	Single Duct Run	Double Duct Run
WG40	203.2	152.4
WG75/WG100/WG175	254	203.2
It is best to oversize ductwork if exact ductwork diameters are not readily available or easily accessible		

Note: The above-referenced sizes are internal diameter in inches for 60Hz and in millimeters for 50Hz. If a single supply duct is used but then splits into two ducts, the duct size that is recommended for double duct runs is used after the split occurs (ex. 8" duct would split into two 6" ducts).

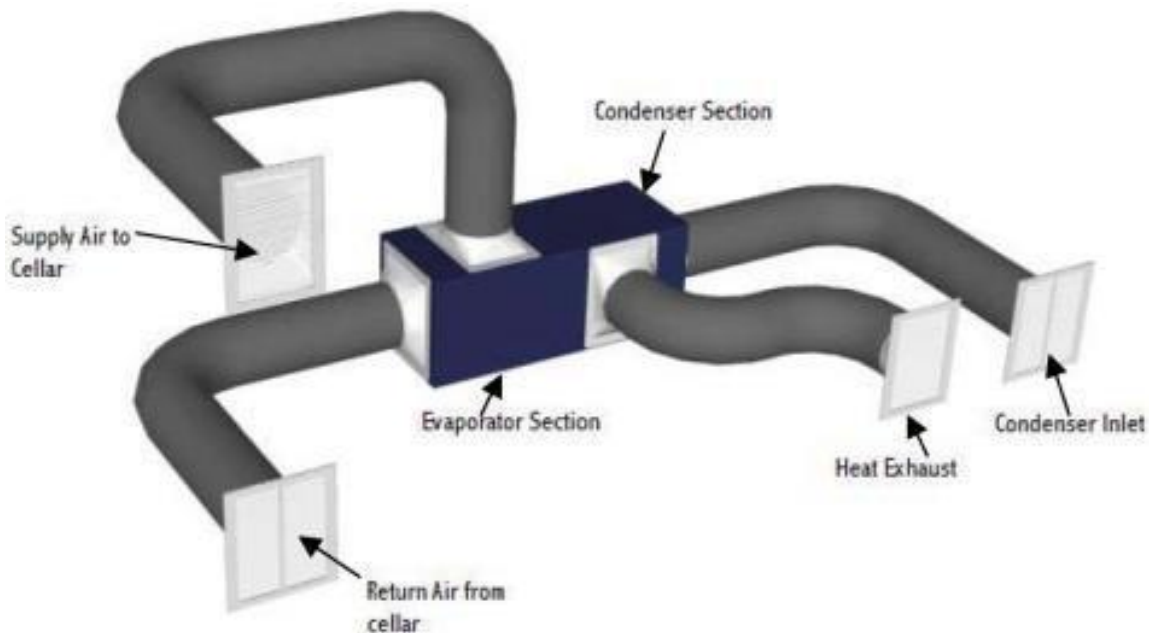

Note: Uninsulated ducts and surfaces cause exposed metal to sweat which can cause a degradation of insulation, a loss of cooling capacity, and in some cases lead to water damage.

Duct Collar and Panel Adjustment



Fig. 1



Fig. 2



Fig. 3



Fig. 4



Fig. 5

To replace or adjust the locations of the panels and Supply Collar please see the instructions below:

1. Determine which panel needs to be replaced (Fig 1).
2. Use a flat blade screwdriver, coin, or other suitable tool at the captive fastener (Fig 2).
3. Apply a simple quarter turn counterclockwise to allow the fastener to disengage from the housing (Fig 3).
4. Remove the panel by sliding the panel/collar up to disengage the bottom hook from the housing before completely removing the panel/collar from the unit (Fig 4).
5. To replace the panel/collar, simply reverse the previous steps. Press the panel against the opening and slide it down to connect the bottom hook of the panel/collar to the housing (Fig 5). Push the top of the panel in and line up the fasteners with holes in the housing. Insert the tool into the fastener and quarter turn clockwise to lock into place.

Drain Line

Connect the drain line onto the barbed fitting of the drain outlet. The Drain Line's interior diameter should be ½". The drain line must extend from the unit to an open floor drain or condensate pump. **DO NOT** install an external trap on the drain line, every ducted wine guardian unit is built with an internal trap. Allow enough height for the drain line to function properly. If draining into a nearby sink, the unit must be elevated higher than the rim of the sink in order for the water to drain by gravity. Install with a ¼" per linear foot of pitch. **DO NOT** tie the condensate drain line directly into the sanitary sewer system. The internal drain trap primes itself automatically once the unit has run for a period of time and after the unit cycles off. This is confirmed by water dripping from the drain.

Wiring to Power

Match the Electrical Wiring to the cord provided on the Wine Guardian. Provide dedicated circuit and wiring for the system. Match the wiring and breaker size to the rated load as shown on the serial plate and in this guide. Please see the sample serial plate illustration.

WINE GUARDIAN®
MODEL: D025
P/N : 99H0250-20
S/N : XX-XX-XXX
REV : X

Refrigerant	R-134A
System Charge	19 oz
Test Pressure	275 psi
Electrical	115/1/60
Min. Circuit amps	8.9
Compressor RLA	5.82
Locked Rotor Amps	32
Condenser Fan Amps	0.8
Evaporator Fan Amps	0.8
Humidifier Amps	0.3
Total Unit Amps	7.4



DANGER

ELECTRICAL SHOCK HAZARD
RISK OF SERIOUS INJURY OR DEATH
The electrical outlet and wiring installation must meet the national and local building codes.

Intertek
59373
Conforms to UL STD 1995
Certified to CAN/CSA STD C22.2 NO. 236

 AIR INNOVATIONS
7000 Performance Dr.
North Syracuse, New York USA 13212
help.wineguardian.com

FCC ID: 2AQX3-WG
IC ID: 24453-2AQX3WVG

*This device complies with part 15 of the FCC Rules. Operation is subject to the following two conditions:
1) This device may not cause harmful interference.
and
2) This device must accept any interference received, including interference that may cause undesired operation.*

S/N : XX-XX-XXX
MODEL: D025
help.wineguardian.com

Do **NOT** modify the plugs in any way. Do **NOT** use extension cords.

Depending on the model the electrical power supply must be either 115-volt or 230-volt AC, 1 phase, 60 cycle. For 50hz systems the electrical power supply must be 240-volt, 1 phase, 50 cycle. The electrical power cannot vary more than plus or minus 4% or damage may occur to the unit.

Plug the unit into the wall outlet, gently pull on the plug to make sure it is tight.

Fig. 1: Plug configurations

Required For:
Models D025/D050

- 115VAC, 60Hz
- NEMA 5-15P

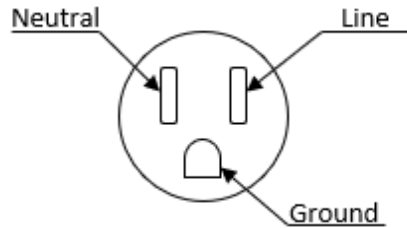

Required For:
Models D088

- 230VAC, 60Hz
- NEMA 6-15P

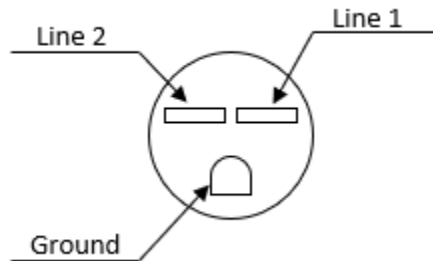

Required For:
Models D200

- 230VAC, 60Hz
- NEMA 6-20P

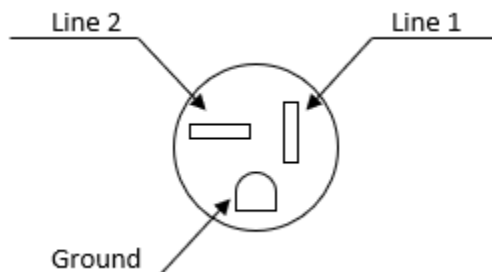

Installing the Remote Interface and Communication Cable



The Wine Guardian Wireless2Base™ Remote Interface Controller is a combination temperature and humidity controller with single stage cooling, heating, and humidity control. Its capacitive touch screen incorporates an on/off switch, adjustment arrows and settings buttons for ease of use and programming. The controller can be installed

one of two ways:

IMPORTANT

Wireless installation may result in limited communication range and connectivity issues depending upon building construction and distance between Wine Guardian unit and Remote Interface Controller and/or Remote Sensors.

Wired (recommended) – wired directly to the Wine Guardian unit through an RJ-9 communication cable. 50' (15.25 m) of control cable is included with each controller with longer lengths available as an option.

IMPORTANT

Whenever possible we strongly suggest wiring the Remote Interface Controller directly to the Wine Guardian unit to avoid periodic battery changes and uninterrupted service.

Wirelessly - connects wirelessly to the Wine Guardian unit by Radio Frequency connectivity through one of twelve selectable channels.

The Wine Guardian Wireless2Base Remote Interface Controller is a configurable device that can be fine-tuned through a series of individual settings. The controller incorporates eight (8) key temperature, humidity, and system alarm points. Remote alarm indication is possible through terminal point connections at our main control board.

In most applications, the remote interface controller will be mounted within the wine cellar. The remote interface controller can also be mounted directly outside of the wine cellar or in any other room of the home or building. When mounted outside the wine cellar, a remote sensor kit or a second wireless remote interface must be purchased and installed within the wine cellar.

IMPORTANT

Regardless of wired or wireless, each Wine Guardian System can have a maximum of two (2) Remote Interface Controllers and three (3) Remote Sensors.

Additional Remote Interface

Prior to adding an additional remote interface to the system, you will have to change setting 30 on the first controller to give it a different address. Refer to page 37 for instructions on how to access the Interface Settings and get to Setting 30 (shown on page 42).

Controller Specification

Application	WG only, single stage cooling or heating Humidification
Programmable	No
Change over	Auto or manual, Fan ON or AUTO
Color	Black (only)
User interface	Touch screen
Auto defrost control	Yes, with Serving temp option
Connection	Communicating – RJ-9 cable
Wireless-to-base communication range	40' line of site
Wireless-to-base channels	12
Remote sensors	wired or wireless
Temperature adjustment	34 to 97 Deg F (1 to 36 Deg C)
Temperature tolerance	+/- 2 Deg F (+/- 1.1 Deg C)
Humidity adjustment	2% to 93% RH
Humidity tolerance	+/- 10% RH
System temperature diagnostics	Not Available
Alarms	High temp, low temp. High humidity, low humidity. High pressure fault. Condensate, Defrost and Communication error

Mounting the Remote Interface Controller (Wired)



Fig. 1

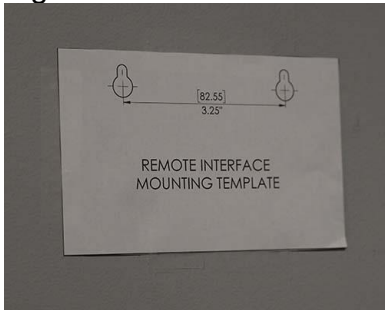

Fig. 2

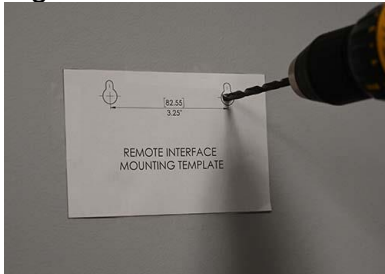

Fig. 3



Fig. 4

1. Remove the comm cable from the zip lock bag and attach it to the side of the Wine Guardian unit (Fig. 1).
 - a. Route the communication cable within the wall and/or ceiling structure of the wine cellar to the desired controller mounting location.
 - b. Plan on mounting the remote interface controller on a solid surface away from doors, corners, air outlets, drafts or heat generating equipment. Do not mount the remote interface controller directly on an outside wall, a wall adjacent to a boiler room, or other hot area. Use a piece of foam insulation behind the sensor to insulate it from a hot or cold surface. The recommended height 5ft to 6ft (1.5m to 1.8m) above the finished floor.
2. Locate the Mounting Template upon the wall where the Controller will be mounted (Fig. 2). Using the crosses on the template to assist in levelling the template.
3. Drill two 1/8" holes and insert anchors at the marked locations. Anchors may not be required if securing to a wall stud or racking system. Insert the screws into the holes and test fit the backing plate to ensure it mounts easily onto the two screws and slides down onto the slotted opening freely (Fig. 3).
4. Plug in the communication cable to the back of the remote interface controller backing plate.
 - a. If using multiple Remote Interfaces either connect each Sensor to each other in series using RJ9 cable or purchase a RJ9 Splitter to be used on the unit.
5. Attach the Controller to the wall (Fig. 4).

Note: if hardwiring a Remote Interface do NOT install any batteries in the Interface.

Mounting the Remote Interface Controller (Wireless)

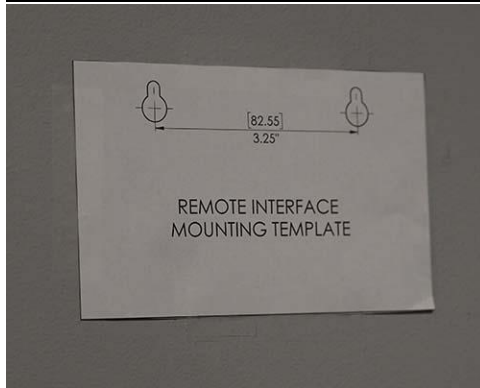

Fig. 1

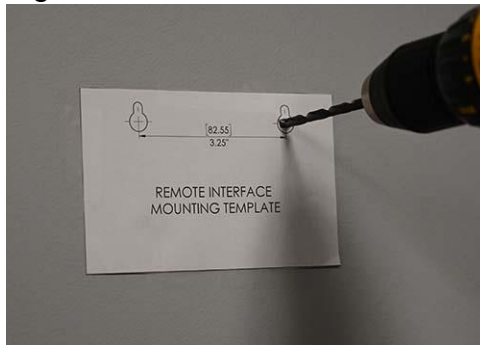

Fig. 2

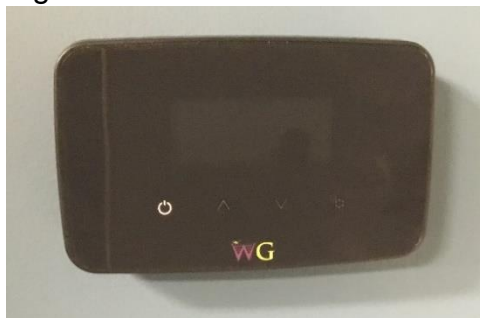

Fig. 3

1. Plan on mounting the remote interface controller on a solid surface away from doors, corners, air outlets, drafts or heat generating equipment. Do not mount the remote interface controller directly on an outside wall, a wall adjacent to a boiler room, or other hot area. Use a piece of foam insulation behind the sensor to insulate it from a hot or cold surface. The recommended height is 5ft to 6ft (1.5m to 1.8m) above the finished floor.
2. Locate the Mounting Template upon the wall where the Controller will be mounted (Fig. 1). Using the crosses on the template to assist in levelling the template.
3. Drill two 1/8" holes and insert anchors within the mounting surface. Anchors may not be required if securing to a wall stud or racking system. Insert the screws into the holes and test fit the backing plate for mounting to ensure it mounts easily onto the two screws and slides down onto the slotted openings freely (Fig. 2)
4. Insert the three AA batteries.
(Only applicable with wireless installations)
5. The system will automatically acknowledge a wireless device (Remote Interface or Remote Sensor). Go to Setting "30" to define the Remote User Interface use.
6. Attach controller to the wall (Fig. 3).

Installation of the Wine Guardian Remote Sensor



The wireless remote sensor is a combination temperature and humidity sensor only. It is designed to be mounted within the wine cellar and can be used in combination with the remote interface controller or up to two additional remote sensors to read and control multiple areas within the wine cellar.

For a wired application you will require a RJ-9 communication cable.

Mounting the Remote Sensor (Wired)



Fig. 1



Fig. 2



Fig. 3

1. Remove the comm cable from the zip lock bag and attach it to the side of the Wine Guardian unit. Route the communication cable within the wall and/or ceiling structure of the wine cellar to the desired controller mounting location.
2. Plan on mounting the remote sensor on a solid surface away from doors, corners, air outlets, drafts or heat generating equipment. Do not mount the remote sensor directly on an outside wall, a wall adjacent to a boiler room, or other hot area. Use a piece of foam insulation behind the sensor to insulate it from a hot or cold surface. The recommended height is 5ft to 6ft (1.5m to 1.8m) above the finished floor.
3. Remove the remote sensor's face plate (Fig. 1) and mark the mounting points at the desired location within the wine cellar (Fig. 2). Also, mark the location of the communication cable connection as this area will require sufficient clearance, for the cable to exit the wall and attach to the back of the sensor.
4. Drill two 1/8" holes and insert anchors within the mounting surface. Anchors may not be required if securing to a wall stud or racking system. Insert the screws into the holes and test fit the backing plate for mounting to ensure it mounts easily onto the two screws and slides down onto the slotted openings freely. (Fig. 3)



Fig. 4

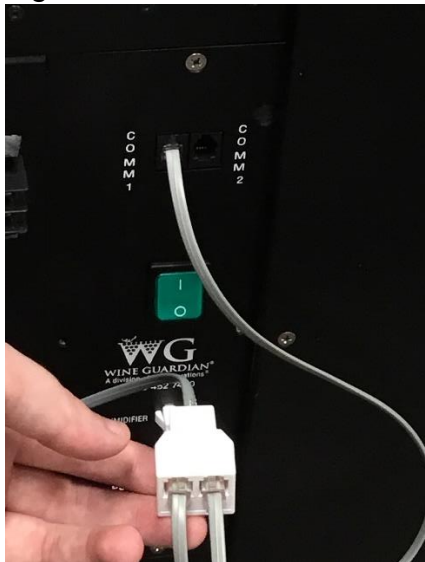

Fig. 5

5. Plug in the communication cable to the remote sensor and mount the Remote Sensor to the wall. (Fig. 3)
6. Reattach the sensor's faceplate (Fig. 4)
7. If multiple sensors are being used either connect each Sensor to each other in series using RJ9 cable or purchase a RJ9 Splitter (Fig. 5) to be connected to the unit.

Note: Remote Sensor's will always be treated as "enabled" when hardwired. Their temperature and humidity readings will always be calculated towards the average by the system.

Note: if the Remote Interface Controller will be located outside the wine room, then change setting 30 to either 3 or 4 to disable its sensors. This will help reduce the possibility of incorrect readings.

Mounting the Remote Sensor (Wireless)



Fig. 1



Fig. 2



Fig. 3



Fig. 4



Fig. 5

1. Plan on mounting the remote sensor on a solid surface away from doors, corners, air outlets, drafts or heat generating equipment. Do not mount the remote sensor directly on an outside wall, wall adjacent to a boiler room, or other hot area as this runs the risk of influencing its temperature readings. The recommended height is 5ft to 6ft (1.5m to 1.8m) above the finished floor.
 2. Remove the sensor face plate (Fig. 1). Mark the mounting points at the desired location within the wine cellar (Fig. 2).
 3. Drill two 1/8" holes and insert anchors within the mounting surface. Anchors may not be required if securing to a wall stud or racking system. Insert screws to secure the sensor to the wall to ensure it mounts easily onto the two screws and slides down onto the slotted openings freely.
 4. Input the three AA batteries. (Fig. 3)
(Only applicable with wireless installations)
 5. Pair the sensor with the unit
(See Page 36 for Pairing Instructions)
- Note: Once Paired the Remote Interface's readings will be included into the system's temperature and humidity averages.***
6. Mount the Remote Sensor on the wall (Fig. 4)
 7. Reattach the sensor's faceplate (Fig. 5)

Remote Sensor Pairing – Multiple Sensors (Wireless)



Fig. 1



Fig. 2



Fig. 3

If using multiple remote temperature/humidity sensors in your application, refer to the figures and the procedure below to change each remote sensor's device number (Three Remote Sensors maximum). Each Remote Sensor must have its own device number and must also be on the same RF channel (Setting 31) as the system they are being paired with.



1. To change the remote sensor's device number, see the following instructions:
 - a. Use a pin to press the button for about half a second and release (Fig. 1).
 - b. Observe the LED on the side of the remote sensor (Fig. 2&3). The LED will flash once for a Device #1, twice for a #2, three times for a #3. At any time, while in this mode press the button once to change the device number. Once each remote sensor has its own unique device number simply wait for the LED to stop flashing and the setting will be saved.
2. To change the remote sensor's RF channel, see the following instructions:

Note: Check what RF Channel the System is set to using Setting 31 to connect your Remote Sensors more easily.

- a. Use a pin to press the red button at the back of the Remote Sensor for 5 seconds until the LED blinks rapidly then release the button.
- b. The LED will flash several times to portray which RF channel it is set to and repeat a total of 3 times.
- c. To change the RF channel, press the button once to increment the RF channel. There are 12 possible RF channels. All Remote Sensors will need to be on the same channel for the system to detect them. To save the RF channel setting simply wait for the mode to time out by not pressing the button.

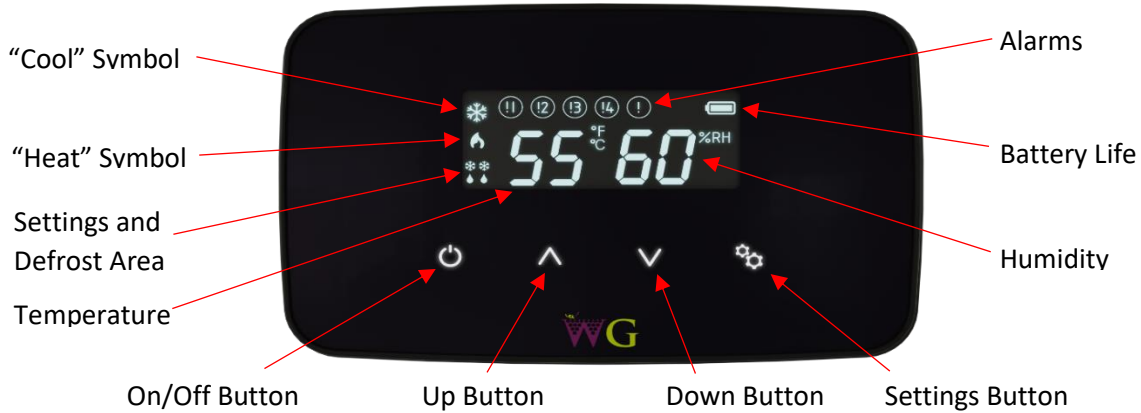



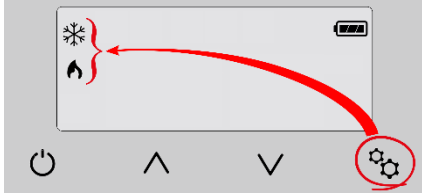

Remote Interface Functions



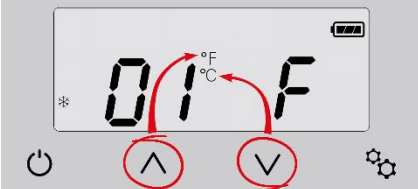





How To:		
Turn system on/off		<ul style="list-style-type: none"> • Press the "On/Off" button once. Note: There is a five (5) minute time delay before the system turns on or turns off.
Change temperature		<ul style="list-style-type: none"> • Press the "Up" arrow once. The display will show the existing temperature setpoint. • Press the up or down arrow buttons to adjust the temperature to the desired set point.
Change humidity		<ul style="list-style-type: none"> • Press the "Up" arrow once. This display will show the existing temperature setpoint. • Press the "Settings" button once to display the "Humidity" setpoint. • Press the "Up" or "Down" arrows to adjust the humidity to the desired set point. Note: A Wine Guardian humidifier must be installed and Setting 6 set to "1" or "2" before the controller will let you change percent humidity.
Change Settings Cooling/ Heating / Auto		<ul style="list-style-type: none"> • Press the Setting button once to display the setting function at the bottom of the screen. • Press the Settings button again to scroll through settings for cool only, heat only or heat/cool only (auto mode).





Settings – Press and hold the “Settings” button for five (5) seconds to access the following settings.



TAP AN ARROW KEY ONCE TO WAKE UP THE CONTROLLER



<p>Degrees F or Degrees C</p>		<p>Setting 1</p> <ul style="list-style-type: none"> • Press the “Up” arrow to change temperature from °F to °C. • Press the “Down” arrow to change temperature from °C to °F.
<p>Low temperature alarm setpoint</p>		<p>Setting 2</p> <ul style="list-style-type: none"> • Press “Settings” button to advance to Setting 2. • Press the “Up” or “Down” arrow buttons to adjust to the desired setpoint. Factory default is 50°F (10°C).
<p>High temperature alarm setpoint</p>		<p>Setting 3</p> <ul style="list-style-type: none"> • Press “Settings” button to advance to Setting 3. • Press the “Up” or “Down” arrow buttons to adjust to the desired setpoint. Factory default is 65°F (18°C).
<p>Low humidity alarm set point</p>		<p>Setting 4</p> <ul style="list-style-type: none"> • Press “Settings” button to advance to Setting 4. • Press the “Up” or “Down” arrow buttons to adjust to the desired setpoint. Factory default is 40%.
<p>High humidity alarm setpoint</p>		<p>Setting 5</p> <ul style="list-style-type: none"> • Press “Settings” button to advance to Setting 5. • Press the up or down arrow buttons to adjust to the desired setpoint. Factory default is 95%.
<p>Add or remove humidifier</p>		<p>Setting 6</p> <ul style="list-style-type: none"> • Press “Settings” button to advance to Setting 6. • Press the “Up” or “Down” arrow buttons to adjust to the desired setpoint. Factory default is zero (0). Zero (0) = No humidifier One (1) = Integral Wine Guardian mounted humidifier Two (2) = Stand-alone remote mounted humidifier

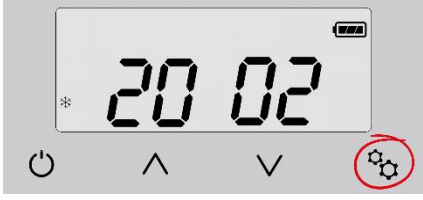

<p>Fan AUTO or ON</p>		<p>Setting 7</p> <ul style="list-style-type: none"> • Press “Settings” button to advance to Setting 7. • Press the “Up” or “Down” arrow buttons to adjust number to the desired set point. Factory default is zero (0). Zero (0) = Auto–fan only turns on when there is a call for cooling or heating One (1) = Fan On–fan remains on continuously
<p>Compressor anti-short cycling</p>		<p>Setting 8</p> <ul style="list-style-type: none"> • Press “Settings” button to advance to Setting 8. • Press the “Up” or “Down” arrow buttons to adjust to the desired time in one-minute increments. Maximum is 10 minutes; minimum is 3 minutes. Factory default is 5 minutes. <p>Compressor anti-short cycling time is the amount of allowable time between compressor stop and restart. Rapid start/stop of compressors can cause premature failure.</p> <p>WINE GUARDIAN DOES NOT RECOMMEND SETTINGS LOWER THAN FACTORY DEFAULT.</p>
<p>Defrost sensor enable/disable</p>		<p>Setting 9</p> <ul style="list-style-type: none"> • Press “Settings” button to advance to Setting 9. • Press the “Up” or “Down” arrow buttons to adjust to the desired setpoint. 1 will equal enabled and a 0 (zero) will equal disabled. <p>If the defrost setting is enabled when no sensor is present the unit will display !3 which will shut off the system.</p>
<p>Defrost cut-in temperature</p>		<p>Setting 10</p> <ul style="list-style-type: none"> • Press "Settings" button to advance to Setting 10. • Press the “Up” or “Down” arrow buttons to adjust to the desired setpoint. This setting is adjustable from 25°F to 40°F. Factory default is 39°F. <p>There must be at least a 1°F difference between defrost cut-in and cut-out set points.</p>

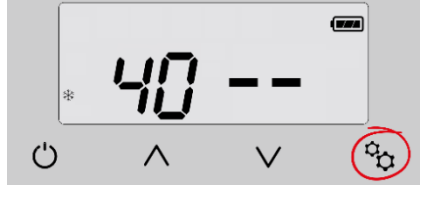
<p>Defrost cut-out temperature</p>		<p>Setting 11</p> <ul style="list-style-type: none"> • Press "Settings" button to advance to Setting 11. • Press the "Up" or "Down" arrow buttons to adjust to the desired setpoint. This setting is adjustable from 35°F to 50°F. Factory default is 40°F. <p>Note: This setpoint must be 1°F/°C higher than setting 10.</p> <p>Note: If °C is selected and then switched back to °F the default cut-out will change to 41°F.</p>
<p>Defrost check interval</p>		<p>Setting 12</p> <ul style="list-style-type: none"> • Press "Settings" button to advance to Setting 12. • Press the "Up" or "Down" arrow buttons to adjust to the desired setpoint. This setting is adjustable from 30 min at 0 (zero), 1 hour at 1, and then in 1 hour increments up to a maximum of 12 hours at 12.
<p>Room temperature offset</p>		<p>Setting 13</p> <ul style="list-style-type: none"> • Press "Settings" button to advance to Setting 13. • Press the "Up" or "Down" buttons to adjust to the desired set point. Maximum setting is +5°F, minimum setting is -5°F. Factory default is zero (0). <p>Room temperature offset changes the actual display reading (temperature only) by the value of this setting.</p> <p>Example: Sensor reading = 55°F (13°C) Setting 13 set to +4 Display reading = 59°F (15°C)</p>

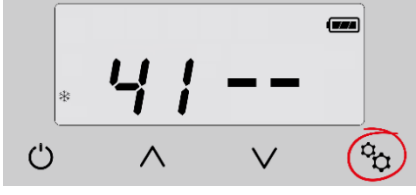
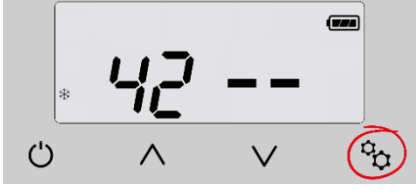
RH offset		Setting 14 <ul style="list-style-type: none"> • Press “Settings” button to advance to Setting 14 • Press the “Up” or “Down” buttons to adjust to the desired setpoint. This setting allows the adjustment of %RH reading by +/-10%. Factory default is 0%RH.
Differential temperature adjustment		Setting 15 <ul style="list-style-type: none"> • Press “Settings” button to advance to Setting 15 • Press the “Up” or “Down” buttons to adjust to the desired setpoint. This setting changes the system/compressor turn-on temperature above setpoint. Factory default is 1°F. Example: Sensor reading = 55°F (13°C) Setting 15 set to +3°F System/compressor turns on at 58°F (14°C)
Temperature deadband		Setting 16 <ul style="list-style-type: none"> • Press “Settings” button to advance to Setting 16. • Press the “Up” or “Down” buttons to adjust to the desired setpoint. This setting is the minimal allowable temperature difference between heating and cooling setpoints. Maximum is 5°F (3°C), minimum is 1°F (1°C). Factory default is 2°F (1°C).
Condensate switch		Setting 17 <ul style="list-style-type: none"> • Press “Settings” button to advance to Setting 17. • Press the “Up” or “Down” buttons to adjust to the desired setpoint. This setting disables or enables the Condensate switch. 0 (zero) is disabled, 1 is enabled. Factory default is 0.
Reserved		Settings 18 & 19 Reserved for additional fields.

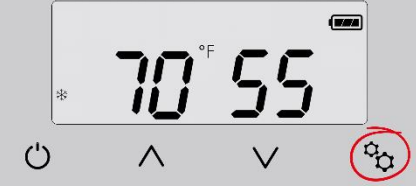
System type defaults		Setting 20 System setting. DO NOT CHANGE.
Reserved		Settings 21-29 Reserved for additional fields.
Define remote user interface		Setting 30 <ul style="list-style-type: none"> • Press “Settings” button to advance to Setting 30 • Press the “Up” or “Down” buttons to adjust to the desired setpoint. <ul style="list-style-type: none"> 1 = Remote User interface #1 mounted within the wine room space and enabled 2 = Remote User interface #2 mounted within the wine room space and enabled 3 = Remote User Interface #1 disabled will display only and can be mounted outside of wine room 4 = Remote User Interface #2 disabled will display only and can be mounted outside of wine room
RF channel select		Setting 31 <ul style="list-style-type: none"> • Press “Settings” button to advance to Setting 31. • Press the “Up” or “Down” buttons to adjust to the desired setpoint. Each system needs all devices to be on the same RF channel. <ul style="list-style-type: none"> 0 = RF disabled - system must be hardwired 1 through 12 = RF enabled and 12 channels available
Reserved		Settings 32-39 Reserved for additional fields.
Thermistor 1 <u><i>No Longer Applicable</i></u>		Setting 40 <ul style="list-style-type: none"> • Press “Settings” button to advance to Setting 40. Not Available Reserved for Thermistor

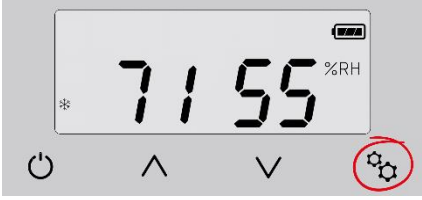
<p>Thermistor 2</p> <p><u><i>No Longer Applicable</i></u></p>		<p>Setting 41</p> <ul style="list-style-type: none"> • Press “Settings” button to advance to Setting 41. <p>Not Available Reserved for Thermistor</p>
<p>Thermistor 3</p> <p><u><i>No Longer Applicable</i></u></p>		<p>Setting 42</p> <ul style="list-style-type: none"> • Press “Settings” button to advance to Setting 42. <p>Not Available Reserved for Thermistor</p>
<p>Thermistor 4</p> <p><u><i>No Longer Applicable</i></u></p>		<p>Setting 43</p> <ul style="list-style-type: none"> • Press “Settings” button to advance to Setting 43. <p>No setting adjustment. Displays the defrost sensor temperature.</p>
<p>Reserved</p>		<p>Setting 44-49</p> <p>Reserved for additional fields.</p>
<p>Output test</p>		<p>Setting 50</p> <ul style="list-style-type: none"> • Press “Settings” button to advance to Setting 50. • Press the “Up” or “Down” buttons to adjust to the desired setpoint. <p>Steps through relays as output test. 0 = Disabled 1 = Enabled</p>
<p>Reserved</p>		<p>Setting 51-69</p> <p>Reserved for additional fields.</p>
<p>Default temperature</p>		<p>Setting 70</p> <ul style="list-style-type: none"> • Press “Settings” button to advance to Setting 70. <p>No setting adjustment. Initial temperature set point. Will revert to this setting upon loss of power.</p>

<p>Default %RH</p>		<p>Setting 71</p> <ul style="list-style-type: none"> • Press “Settings” button to advance to Setting 71. <p>No setting adjustment.</p> <p>Initial relative humidity set point. Will revert to this setting upon loss of power.</p>
<p>Default mode</p>		<p>Setting 72</p> <ul style="list-style-type: none"> • Press “Settings” button to advance to Setting 72. • Press the “Up” or “Down” buttons to adjust to the desired setpoint. <p>Initial mode set point. Will revert to this setting upon loss of power.</p> <p>1 = Auto 2 = Cool 3 = Heat</p>

Alarm Codes

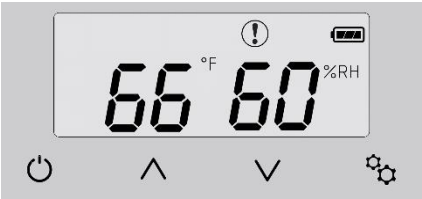
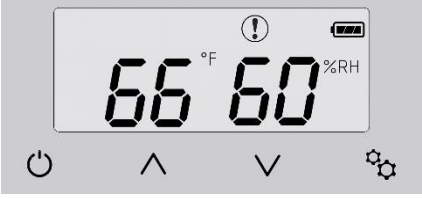
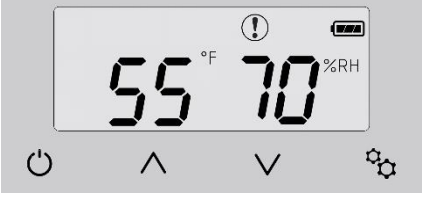
<p>High temperature alarm</p> <p>Flashing temperature number</p>		<p>Flashing temperature number along with (!) symbol will remain on screen until temperature falls below the High Temperature Alarm set point (Setting 3).</p>
<p>Low temperature alarm</p> <p>Flashing temperature number</p>		<p>Flashing temperature number along with (!) symbol will remain on screen until temperature rises above the Low Temperature Alarm set point (Setting 2).</p>
<p>High humidity alarm</p> <p>Flashing humidity number</p>		<p>Flashing humidity number along with (!) symbol will remain on screen until humidity falls below the High Humidity Alarm setpoint (Setting 5).</p>

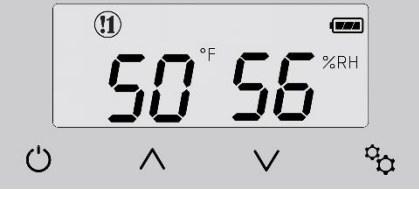
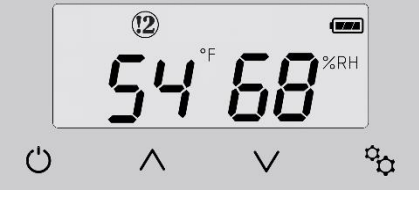
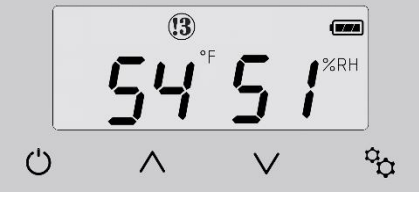
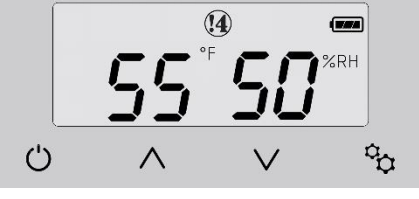
<p>Low humidity alarm</p> <p>Flashing humidity number</p>		<p>Flashing humidity number along with (!) symbol will remain on screen until humidity rises above the Low Humidity Alarm set point (Setting 4).</p>
<p>!1 = High Pressure Switch Fault</p>		<p>THIS ALARM FORCES THE SYSTEM TO SHUT DOWN</p> <p>(!1) will remain on screen until the High Pressure reset switch has been reset. See the trouble shooting guide page 50 for “Instructions to Reset High Pressure Switch”.</p>
<p>!2 = CS (Condensate Switch Fault)</p>		<p>THIS ALARM FORCES THE SYSTEM TO SHUT DOWN</p> <p>(!2) will remain on screen until the CS (condensate switch) fault is resolved and reset.</p>
<p>!3 = Defrost Sensor Fault</p>		<p>THE SYSTEM REMAINS OPERATIONAL DURING THIS ALARM</p> <p>Defrost sensor has been shorted, disconnected or open. (!3) will remain on screen until the defrost sensor issue has been resolved.</p>
<p>!4 = Communication loss</p>		<p>THE SYSTEM REMAINS OPERATIONAL DURING THIS ALARM</p> <p>Bad or no data transfer between sensing device and main control board. “!4” will remain on screen until communication is re-established.</p>

! WARNING !

If multiple units are installed close to each other, make sure the radio is turned off (setting 31)

Start-Up

- Check over the installation and ensure all wiring connections are correct
- Examine all duct connections, grilles, and panels in case any are not connected
- Start the unit
- Check ducts and duct connections for any possible air leaks
- Confirm condenser airflow is unrestricted

Now that the installation is complete plug in the unit. Turn-on the on/off switch on the side of the unit. The on/off switch lights up to indicate power to the unit. The unit may not turn on right away due to the timer built into the circuiting to prevent compressor short cycling. The fan will only run when the system has a call for cooling which will occur when the wine room's temperature is above the setpoint (default of 55°F or 13°C). Once the unit begins cooling wait the allotted 5 minutes for the compressor to run. To check if the compressor is running, check if cool air is leaving the evaporator or if you can hear a humming noise from the compressor itself.

During the initial start-up, the unit may run continuously for several hours, up to a day or more, while it lowers the cellar temperature. Once the unit reaches the set point temperature, it shuts off and starts to cycle on and off as it continues to lower the bottle temperature to the set point. The cellar air reaches the set point before the bottles. If the cellar temperature started at 75 °F (24 °C), the supply air temperature discharged from the unit will probably be 15 °F to 20 °F (-4 to -7 °C) colder. As the cellar temperature decreases to 55 °F (13 °C), the supply temperature differential decreases 8 to 12 °F (4.4 to 6.7°C) colder.

To decrease the run-time of the unit it is recommended to use a step down process. For example, if you are aiming to hit a 55 degrees F setpoint then you would set an initial set point of 63 degrees F. Once the system has reached 63 degrees F change the set point to 60 degrees F, then 55 degrees F. Drop the setpoint in increments, so the system has time to cycle instead of running continuously to reach the preferred set point.

Please note that the Remote Interface Controller will display a "High Temperature" alarm until the wine room's temperature falls below the set point. Please see the *Alarm Codes* section of the manual.

Maintenance



High Voltage

Risk of Serious Injury or Death

Use Lockout/Tagout Procedure before opening panels

Sharp Edges

Risk of Serious Injury

Sharp Edges are present on the fan wheels, housing, fins, and coils

Maintenance on Wine Guardian units requires working with high voltage and sheet metal with possible sharp edges. Only qualified personnel should perform maintenance. Some tasks require knowledge of mechanical and electrical methods. Make sure you are familiar with all hazards, general safety related procedures, and safety labels on the unit.

Standing water in drain pans promote microbial growth (mold) that cause unpleasant odors and serious health-related indoor air quality problems. If mold is found, remove it immediately and sanitize that portion of the unit.

The Wine Guardian is designed for minimal maintenance. The refrigerant system is hermetically sealed and requires no maintenance. The fans are permanently lubricated and require no maintenance. Some maintenance to the unit may be required due to dust or dirt in the air stream.

The condenser coil is provided with a reusable, washable air filter. The filter protects the coil from becoming coated or plugged by dust. Frequency of cleaning the filters is based on the amount of dust or dirt generated in the cellar or basement.

1. Remove the duct collar on the inlet end of the unit. (Optional)
2. Remove the filter covering the face the coil.
3. Wash it under warm water.
4. Shake off excess water.
5. Inspect and clean the face of the coil. **Sharp edges are present on the fins and coils.**
6. Reinstall the filter.
7. Replace the duct collar.

The condensate drain system traps dust and dirt. Clean the drain system once a year.

1. Shut off the rocker switch and unplug the unit.
2. Remove the grille or duct on the evaporator inlet.
3. Inspect the drain pan under the coil.
4. If drain pan appears soiled, pour some hot water mixed with liquid bleach (diluted solution) along the length of the pan to flush the dirt down the drain tube. Continue this treatment until the drain appears clean and free of dirt.
5. Duct collar.
6. Plug in the unit and restart.

Flushing the Water Regulating Valve – Water-Cooled Only

To clear any sediment that may accumulate, valves may be manually flushed by inserting screwdrivers under both sides of the main spring and lifting upwards to flush the valve. Manual flushing does not affect valve adjustments.

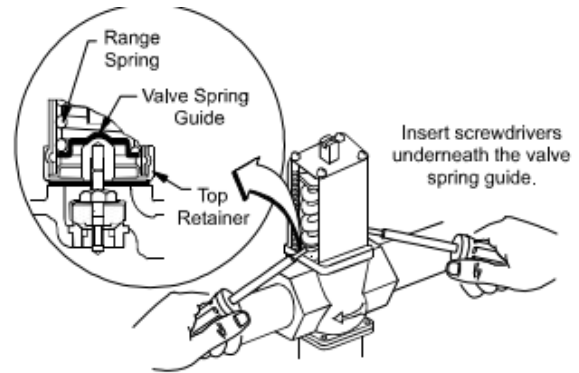

Cleaning the Humidifier (Optional)

If the unit was furnished with a humidifier, it requires periodic maintenance. Follow the instructions in the humidifier guide.

Maintenance Schedule

Monthly

(or quarterly depending on experience with cellar)

- Check filter and drain trap – clean if needed.
- Check for noise or vibration.
- Check for short-cycling of the unit – a turning on and off of the compressor unit more than eight times/hour.

Yearly

(in addition to monthly)

- Replace filters if worn or plugged beyond cleaning.
- Check evaporator and condenser coils for dirt – use a vacuum with a brush attachment to clean the coils.
- Clean the condensate pan under the evaporator coil by flushing. Be careful to keep the drains pans clear of all debris.
- Inspect cabinet for corrosion or rusting – clean and paint.
- Inspect for dirt buildup on or inside the unit. Clean unit by vacuuming or wiping it down.
- Check for loose insulation, fasteners, gaskets, or connections.
- Check the wiring connections and integrity of cords.
- Examine ducts for any cracks or breach.
- Check fan and solenoid on humidifier.
- Replace humidifier drip pad (if applicable)

Troubleshooting

Before proceeding, read and understand the safety information contained in the Safety Section of the Wine Guardian Manual

For in-depth Troubleshooting please head to:

Help.wineguardian.com

Resetting the High-Pressure Switch

High-Pressure Switch Has Shut Down the Unit	
Every Wine Guardian unit has a manual reset high pressure switch in the refrigeration system. This switch shuts the compressor and condenser down if the head pressure in the system is too high. It is intended to protect the compressor. Restricted airflow through the condenser is the most common reason for the pressure to become too high. This can be caused by dust covering the filter or an obstruction blocking the airflow in the duct or grille.	
Possible Cause	Solution
Head Pressure in unit is too high because an obstruction is restricting airflow	Remove the obstruction in the duct/grille or clean the filter. Then restart the unit after resetting the high-pressure switch

1. Shut off the unit at the power switch, Remove the access panel, grille, or duct collar on the condenser to gain access to the High-Pressure Switch.
2. Locate the High-Pressure Switch near the compressor (Fig. 1).
3. Push the button to reset the High-Pressure Switch.
4. Push the power switch to restart the unit.



Fig. 1

Please see the link below for a video on how to reset the High-Pressure Switch
<https://www.youtube.com/watch?v=TFGFTWZVeAs>

Contact and Warranty

GENERAL

Wine Guardian warrants, to the original buyer, its goods, and all parts thereof to be free from defects in material and workmanship for a period of two (2) years from the date of invoicing assuming NORMAL USE AND SERVICE.

LIABILITY

Wine Guardian liability shall be limited to the repair or replacement (at its option) of any part, which, at our sole discretion, is determined to be defective. The purchaser shall pay all transportation costs. Additionally, if a malfunction occurs within the first year from the date of invoice, Wine Guardian will reimburse the reasonable cost of labor required for the repair or replacement provided authorization is obtained from one of our authorized representatives prior to incurring any labor charges.

LIMITATIONS OF LIABILITY

THESE WARRANTIES ARE MADE IN LIEU OF ALL OTHER WARRANTIES EXPRESSED OR IMPLIED, INCLUDING ANY IMPLIED WARRANTY OF MERCHANTABILITY OR FITNESS FOR A PARTICULAR PURPOSE AND IN LIEU OF ANY OTHER OBLIGATION OR LIABILITY, INCLUDING LIABILITY FOR ANY INCIDENTAL OR CONSEQUENTIAL DAMAGES. Wine Guardian will not be responsible for any costs or liabilities whatsoever resulting from improper installation or service of its equipment. In the event that Wine Guardian or its distributors are found liable for damage based on any defect or nonconformity in the products, their total liability for each defective product shall not exceed the purchase price of such defective products. No person or representative is authorized to change these warranties or assume any other obligations or liabilities for Wine Guardian in connection with the sale of its systems.

INDEMNIFICATION

Purchaser agrees to indemnify, hold harmless and defend seller and its officers, directors, agents, and employees from and against any and all claims, liabilities, costs and expenses arising out of or related to Purchaser's use of the goods, or in any way involving injury to person or property or accident occasioned by the goods sold by Wine Guardian to Purchaser.

FOREIGN GOVERNMENT AND INDIAN NATIONS

If Purchaser is a foreign government or an Indian nation, Purchaser hereby expressly waives its defense of sovereign immunity in the event of a dispute between Purchaser and Wine Guardian regarding this invoice and Purchaser expressly acquiesces to the jurisdiction of the federal and state courts of the United States.

SEVERABILITY

If one or more of the provisions contained in this contract shall for any reason be held to be invalid, illegal, or unenforceable in any respect, such invalidity, illegality, or unenforceability shall not affect any provision of this contract, but this contract shall be

construed as if such invalid, illegal or unenforceable provision had never been contained.

ADDITIONAL REQUIREMENTS

If a defect covered by the Warranty occurs, contact Wine Guardian for authorization to proceed with corrective action. Do not return any parts or incur any charges for which you expect to be reimbursed under this Warranty without receiving this authorization. If parts are replaced under this Warranty, the defective parts must be returned prepaid within 30 days. This warranty shall be null and void in its entirety if the Serial Number on the air conditioner or compressor is altered, removed, or defaced.

Contact Information

Wine Guardian
7000 Performance Drive
North Syracuse, NY, 13212

Web sites: wineguardian.com
Help.wineguardian.com

Email: info@wineguardian.com

Warranty

The Wine Guardian unit serial number is noted on all packing lists and bills of lading and, along with shipping date, is kept on file at Wine Guardian for warranty purposes.

All correspondence regarding warranty must include the model number and serial number of the unit involved. **Note** that the warranty is null and void if the serial number on the unit or compressor is altered, removed, or defaced. All Inquiries or correspondence regarding warranty should be handled in accordance with the "Warranty" and directed to:

Wine Guardian
7000 Performance Drive
North Syracuse, New York, 13212
Attn: Service Department

This procedure includes but is not limited to

- Obtaining authorization from Wine Guardian prior to incurring any charges for repair or replacement under warranty.
- Or returning prepaid within 30 days any and all defective parts.