



Item# SML336102



Specifications

Category: Semi-Flush Mount	Finish: Black
Fixture Dimension: 45"L x 20"W x 30"H	Overall Height: 30"
Chain/Rod Length: N/A	Wire Length: 1 ft.
Bulb: 4x40W E26 - NOT INCLUDED	Maximum Wattage per Bulb: 40W
Voltage: 120V	Fixture Weight: 1.9Kg (4.2Lbs)
Location Rating: Suitable for Damp Location	Safety Certification: cUL



Wire Connections

ATTENTION

FIXTURE INSTALLATION MUST BE DONE BY A LICENSED ELECTRICIAN

SHUT OFF POWER SUPPLY AT FUSE OR CIRCUIT BREAKER

USE ONLY THE SPECIFIED BULBS AND DO NOT EXCEED THE MAXIMUM WATTAGE

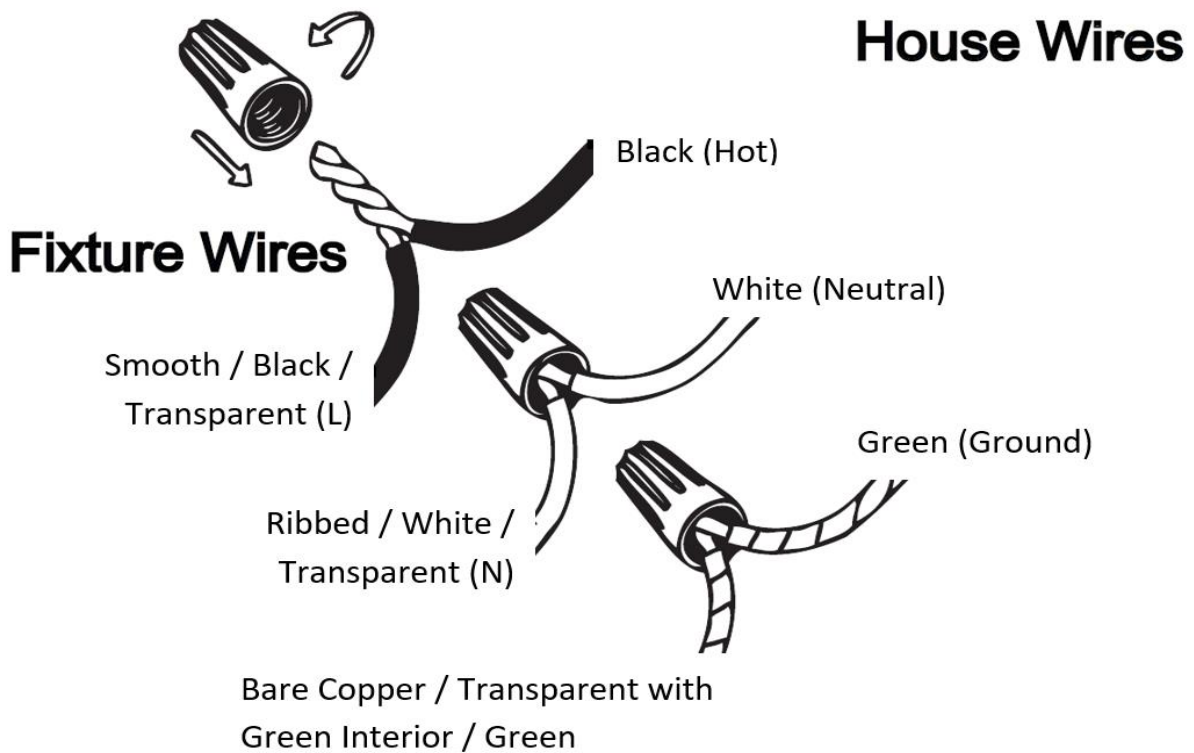

Use standard wire connectors to make all wire connections

Twist connectors until wires are tightly joined

Wrap each connection with approved electrical tape and carefully stuff all the connected wires into outlet box





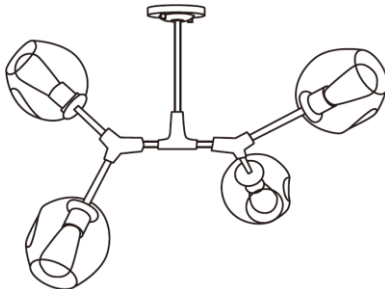

Assembly Instructions

Item# SML336102



Parts component list

1	2	3	4	5
				
1x	2x + 1 extra 1 1/8"	3x + 1 extra	2x 1 1/8"	2x + 1 extra

Legend

L = Line/Hot/Black

N = Neutral/White

 = Ground/Green

STEP 1

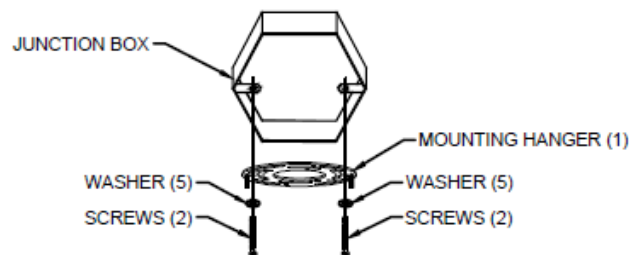

Secure the mounting hanger (1) to the electric junction box with the screws (2) and washers (5) provided.

STEP 2

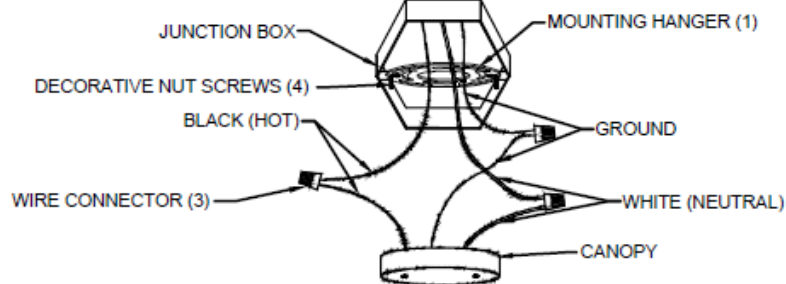

Connect the hot wire from main wire to the hot wire from power supply. Connect the neutral wire from the main wire to the neutral wire from power supply. Fix the ground wire from fitting to ground wire (grounding) from power supply.

STEP 3

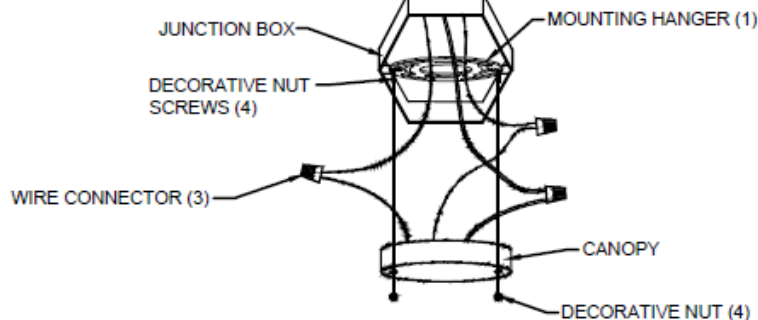

Install the recommended bulb in the socket, and then install the canopy (shade/cover) of the decorative fixture to the mounting hanger, using the supplied screws or decorative nuts (4).

