



## **Item# SML433103**

### **Specifications**

---

Category: Wall Lamp

---

Fixture Dimension: D13"x7"xH10"

---

Wire/Chain Length: N/A

---

Fixture Weight: 11Lbs(5Kg)

---

Fixture Finish: Crystal and Iron with Matt Black & Satin Brass

---

Bulb: 3x40W E12 Base-NOT INCLUDED

---

Maximum Wattage: 40W

---

Voltage: 120V

---

Approved Location: Dry Location

---

Safety Certification: CUL

---



# Assembly Instructions

## Item# SML433103

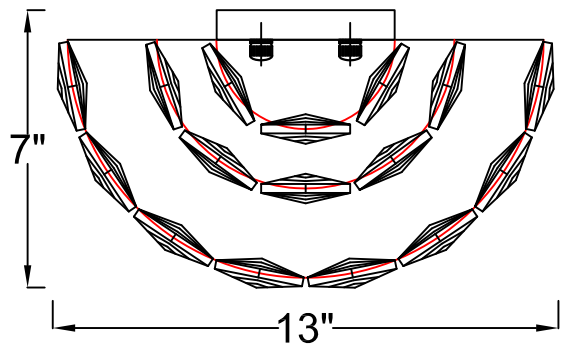
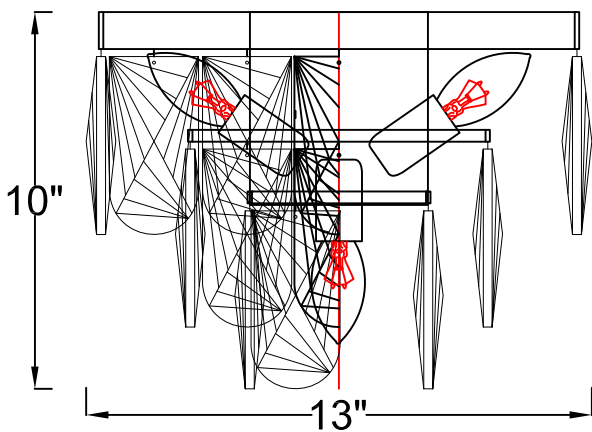
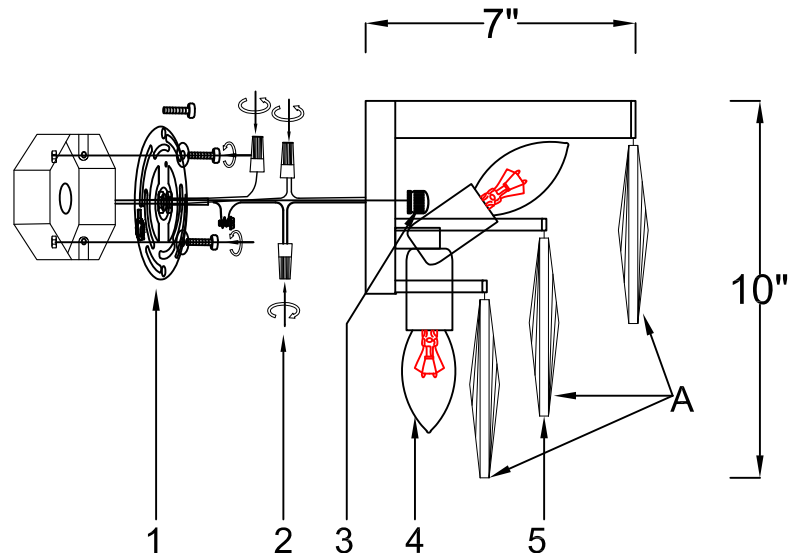
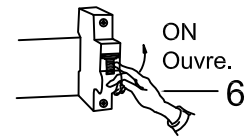
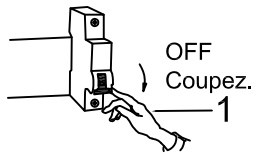

### Crystal Equipped

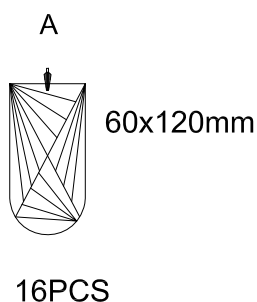

### How to Install

1. Shut off Power, Do a complete inventory of all parts and components before you start installing.
2. Install the Mounting Plate on the outlet box.
3. Use the wire connectors to connect wires.
4. Attach the Frame to the Mounting Plate.  
Secure it with ball nuts.
5. After safety attaching fixture into outlet box, Install bulbs.
6. Dress the fixture with Crystal A.
7. Proceed to connecting the power.



## Wire Connections

### **ATTENTION:**

THIS PRODUCT MUST BE INSTALLED IN ACCORDANCE WITH THE APPLICABLE INSTALLATION CODE BY A PERSON FAMILIAR WITH THE CONSTRUCTION AND OPERATION OF THE PRODUCT AND THE HAZARDS INVOLVED.

### **Note:**

CE PRODUIT DOIT ÊTRE INSTALLÉ SELON LE CODE D'INSTALLATION PERTINENT, PAR UNE PERSONNE QUI CONNAÎT BIEN LE PRODUIT ET SON FONCTIONNEMENT AINSI QUE LES RISQUES INHÉRENTS.

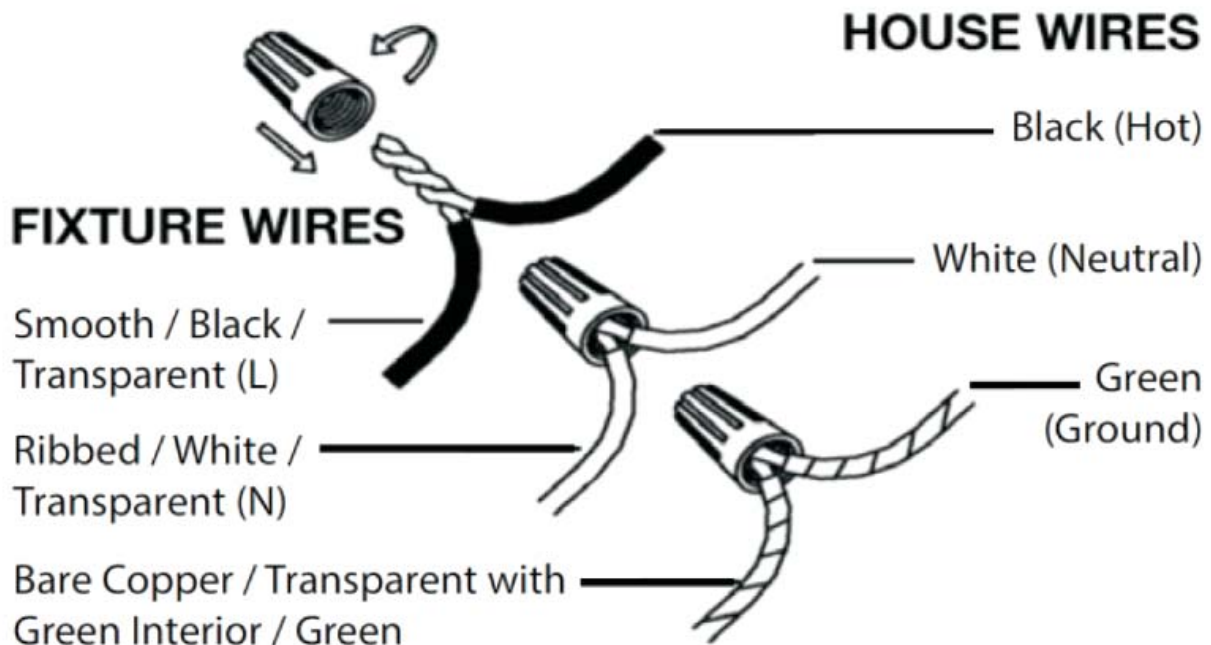

Use standard wire connectors to make all wire connections.

Twist connectors until wires are tightly joined together.  
Wrap each connection with approved electrical tape and carefully stuff all the connected wires into outlet box.