

19076 Ø190mm X 67MM

General Specifications

MATERIAL	Impeller - Plastic
MOTOR TYPE	AC Induction Capacitor Motor
BEARING TYPE	Ball Type
TEMPERATURE RANGE	Operating temperature -20°C ~ 70°C
CONNECTION	Lead Wires
DIELECTRIC STRENGTH	1800 VAC for 1 Sec.
INSULATION RESISTANCE	10M Ω min. @500 VDC
TYPE OF INSULATION	Class F
INGRESS PROTECTION	IP54
SAFETY	Thermally Protection (Auto Restart)
RoHS COMPLIANCE	YES
WEIGHT	890 g



Specifications

Model	#Bearing Type	Rated Voltage	Frequency	Input Current	Input Power	Speed	Max Air Flow		Max Static Pressure		Noise	Weight
Part No.	B	VAC	Hz	Amp	Watt	RPM	CFM	m ³ /min	Inch-H ₂ O	mmH ₂ O	dB-A	g
sACF19067V1HBL	B	115	50/60	0.39/0.42	45/48	2000/1600	256/224	7.25/6.34	1.10/1.10	28/28	61/59	800
sACF19067V2HBL	B	230	50/60	0.17/0.19	39/44	2000/1600	256/224	7.25/6.34	1.10/1.10	28/28	61/59	800

Specifications are subject to change without notice. Please visit our website at <http://www.sofasco.com> for update information

Dimensions (Unit:mm)

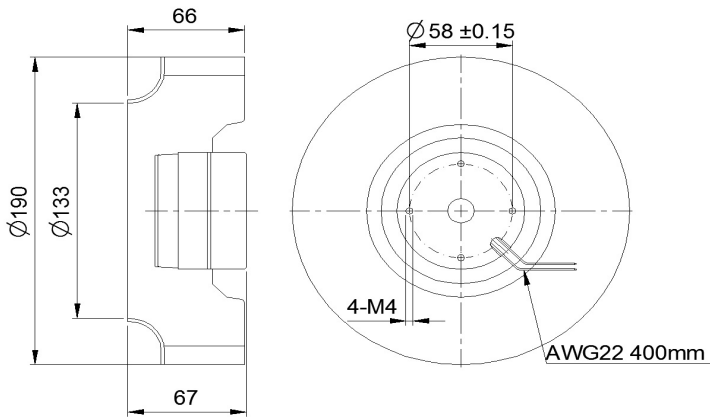

PQ Curve (At rated Voltage)

