

## 17569 Ø175mm X 69MM

### General Specifications

MATERIAL	Impeller - Plastic
MOTOR TYPE	AC Induction Capacitor Motor
BEARING TYPE	Ball Type
TEMPERATURE RANGE	Operating temperature -20°C ~ 70°C
CONNECTION	Lead Wires
DIELECTRIC STRENGTH	1800 VAC for 1 Sec.
INSULATION RESISTANCE	10M Ω min. @500 VDC
TYPE OF INSULATION	Class F
INGRESS PROTECTION	IP54
SAFETY	Thermally Protection (Auto Restart)
RoHS COMPLIANCE	YES
WEIGHT	870 g



### Specifications

Model	#Bearing Type	Rated Voltage	Frequency	Input Current	Input Power	Speed	Max Air Flow		Max Static Pressure		Noise	Weight
Part No.	B	VAC	Hz	Amp	Watt	RPM	CFM	m <sup>3</sup> /min	Inch-H <sub>2</sub> O	mmH <sub>2</sub> O	dB-A	g
sACF17569V1HBL	B	115	50/60	0.48/0.54	53/63	2600/2900	294/313	8.32/8.86	1.10/1.45	28/37	66/68	870
sACF17569V2HBL	B	230	50/60	0.22/0.28	52/64	2600/2900	294/313	6.88/7.82	1.10/1.45	28/37	66/68	870

Specifications are subject to change without notice. Please visit our website at <http://www.sofasco.com> for update information

### Dimensions (Unit:mm)

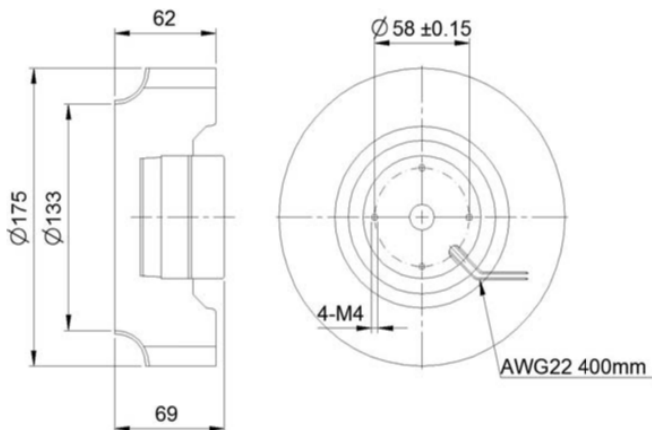

### PQ Curve (At rated Voltage)

