

## 220mm BACKWARD CURVED CENTRIFUGAL FANS WITH SUPPORT BRACKET

### INFORMATION

IMPELLER:	PA66+GF
BLADE NO.:	7 BLADES
BEARING:	NMB BALL BEARING
LEAD WIRES	Red, Blue(AWG18#); Yellow, White(AWG24#)
INSULATION :	CLASS B
OPERATING TEMPERATURE:	-25°C to 60°C
SPEED CONTROL	CONTROL INPUT 0~10VDC / PWM
LIFE EXPECTANCE	50,000 Hours at At 40°C
SIGNAL OUTPUT	FG (Frequency Generator)
RoHS COMPLIANCE	Yes.
IP LEVEL	IP55 (Special IP Rating On Request)



### SPECIFICATION

MODEL NO.	RATED VDC	OPERATED VOLTAGE (VDC)	SPEED (RPM)	RATED CURRENT (A)	INPUT POWER (W)	Max. M <sup>3</sup> /H	Air Flow CFM	Max. Static inch-H2O	Pressure PA	Noise Level dB(A)
<b>ECFK27089V24HB-PB</b>	<b>24</b>	<b>16~28</b>	<b>2600</b>	<b>3.40</b>	<b>85</b>	<b>1010</b>	<b>594.39</b>	<b>2.80</b>	<b>700</b>	<b>71</b>

### DRAWING:

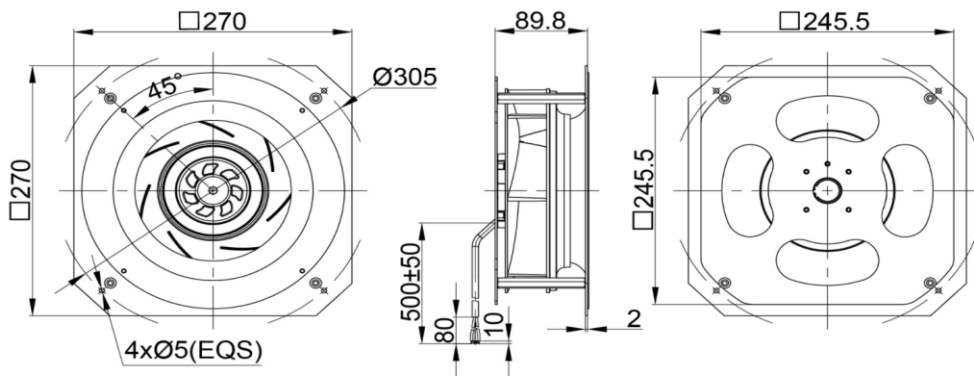

### PQ CURVE:

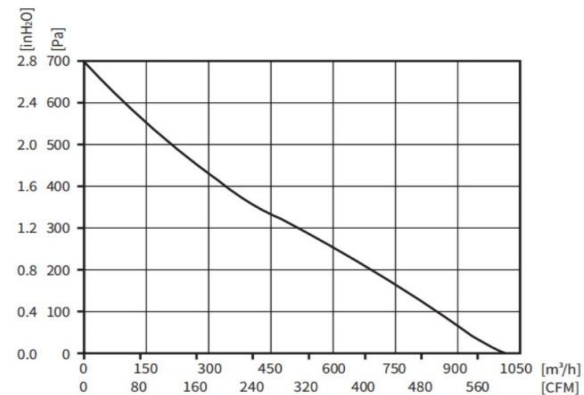

Specifications are subject to change without notice. Please visit our website at <http://www.sofasco.com> for update information.