

175mm BACKWARD CURVED CENTRIFUGAL FANS WITH SUPPORT BRACKET

INFORMATION

IMPELLER:	PA66+GF
BLADE NO.:	7 BLADES
BEARING:	NMB BALL BEARING
LEAD WIRES	Red, Blue(AWG18#); Yellow, White(AWG24#)
INSULATION :	CLASS B
OPERATING TEMPERATURE:	-25°C to 60°C
SPEED CONTROL	CONTROL INPUT 0~10VDC / PWM
LIFE EXPECTANCE	50,000 Hours at At 40°C
SIGNAL OUTPUT	FG (Frequency Generator)
RoHS COMPLIANCE	Yes.
IP LEVEL	IP55 (Special IP Rating On Request)



SPECIFICATION

MODEL NO.	RATED VDC	OPERATED VOLTAGE (VDC)	SPEED (RPM)	RATED CURRENT (A)	INPUT POWER (W)	Max. M ³ /H	Air Flow CFM	Max. Static inch-H ₂ O	Pressure PA	Noise Level dB(A)
ECFK22681V48HB-PB	48	36~57	4300	1.80	85	750	441.38	2.60	650	72

DRAWING:

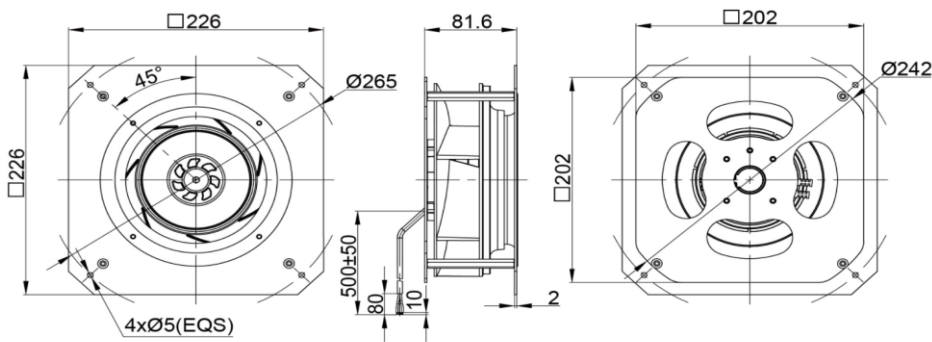

PQ CURVE:

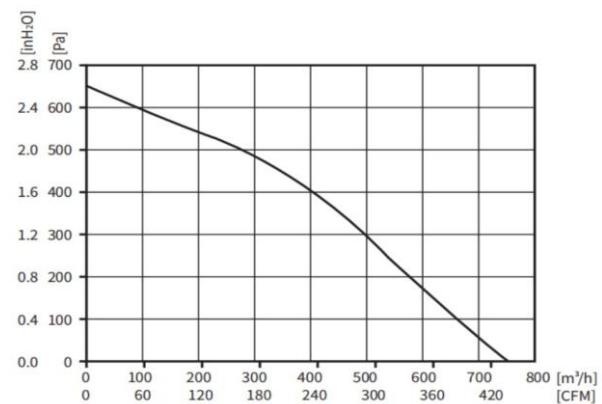

Specifications are subject to change without notice. Please visit our website at <http://www.sofasco.com> for update information.