

## 190mm BACKWARD CURVED CENTRIFUGAL FANS WITH SUPPORT BRACKET

### INFORMATION

IMPELLER:	PA6+GF
BLADE NO.:	7 BLADES
BEARING:	NMB BALL BEARING
LEAD WIRES	AC (AWG20#), DC (AWG22#)
INSULATION :	CLASS B
OPERATING TEMPERATURE:	-25°C to 60°C
SPEED CONTROL	CONTROL INPUT 0~10VDC / PWM
LIFE EXPECTANCE	50,000 Hours at At 40°C
SIGNAL OUTPUT	FG (Frequency Generator)
RoHS COMPLIANCE	Yes.
IP LEVEL	IP44 (Special IP Rating On Request)



### SPECIFICATION

MODEL NO.	RATED VAC	OPERATED VOLTAGE (VAC)	SPEED (RPM)	RATED CURRENT (A)	INPUT POWER (W)	Max. M <sup>3</sup> /H	Air Flow CFM	Max. Static inch-H <sub>2</sub> O	Pressure PA	Noise Level dB(A)
<b>ECFK22597V2MB-PB</b>	<b>230</b>	<b>184~270</b>	<b>3570</b>	<b>0.70</b>	<b>93</b>	<b>795</b>	<b>467.86</b>	<b>2.74</b>	<b>686</b>	<b>72</b>

### DRAWING:

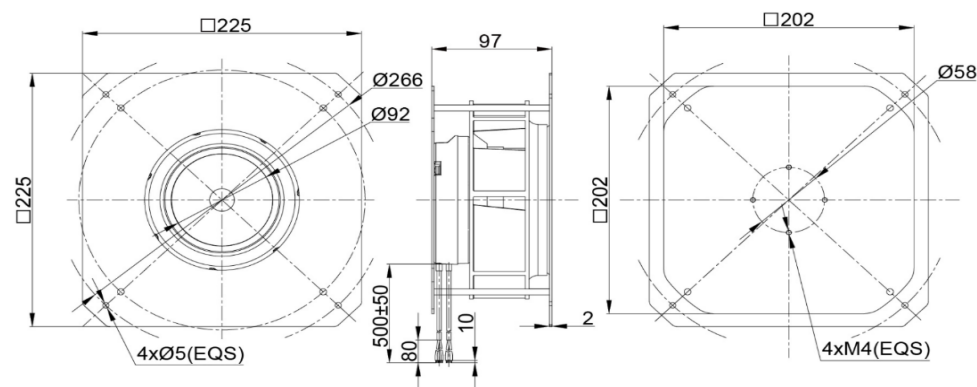

### PQ CURVE:

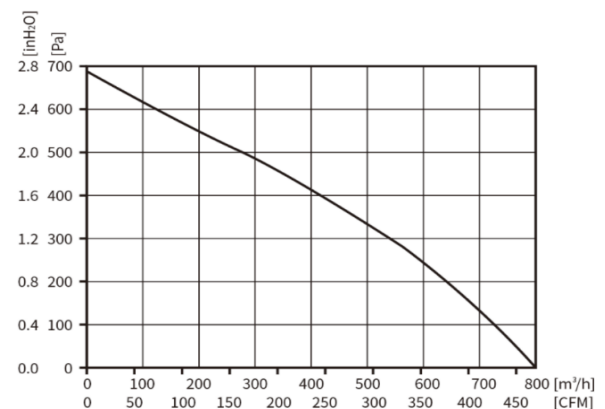

Specifications are subject to change without notice. Please visit our website at <http://www.sofasco.com> for update information.