

## 175mm BACKWARD CURVED CENTRIFUGAL FANS WITH SUPPORT BRACKET

### INFORMATION

IMPELLER:	PA6+GF
BLADE NO.:	7 BLADES
BEARING:	NMB BALL BEARING
LEAD WIRES	AC (AWG20#), DC (AWG22#)
INSULATION :	CLASS B
OPERATING TEMPERATURE:	-25°C to 60°C
SPEED CONTROL	CONTROL INPUT 0~10VDC / PWM
LIFE EXPECTANCE	50,000 Hours at At 40°C
SIGNAL OUTPUT	FG (Frequency Generator)
RoHS COMPLIANCE	Yes.
IP LEVEL	IP44 (Special IP Rating On Request)



### SPECIFICATION

MODEL NO.	RATED VAC	OPERATED VOLTAGE (VAC)	SPEED (RPM)	RATED CURRENT (A)	INPUT POWER (W)	Max. M <sup>3</sup> /H	Air Flow CFM	Max. Static inch-H <sub>2</sub> O	Pressure PA	Noise Level dB(A)
<b>ECFK225102V2HB-PB</b>	<b>230</b>	<b>184~270</b>	<b>4460</b>	<b>0.85</b>	<b>105</b>	<b>810</b>	<b>476.69</b>	<b>2.98</b>	<b>744</b>	<b>76</b>

### DRAWING:

### PQ CURVE:

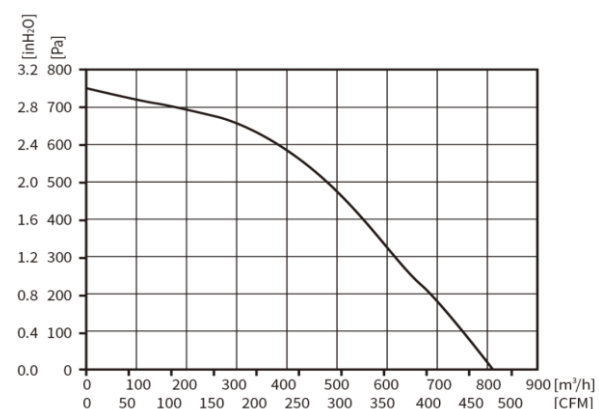
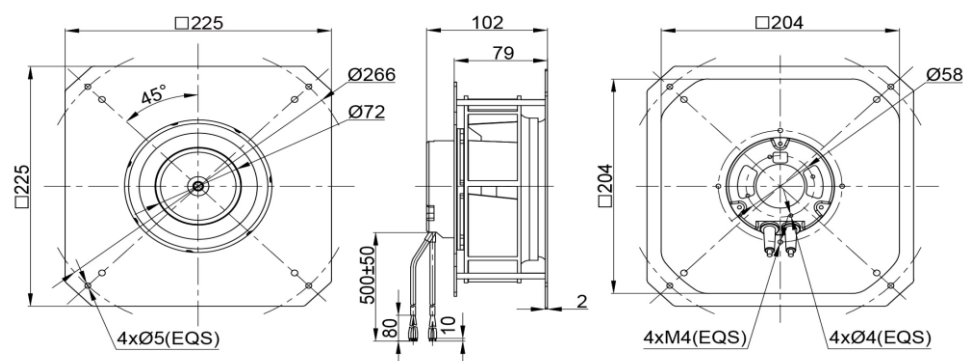

Specifications are subject to change without notice. Please visit our website at <http://www.sofasco.com> for update information.