

## 133mm BACKWARD CURVED CENTRIFUGAL FANS WITH SUPPORT BRACKET

### INFORMATION

IMPELLER:	PA66+GF
BLADE NO. :	7 BLADES
BEARING:	NMB BALL BEARING
LEAD WIRES	AC (AWG20#), DC (AWG24#)
INSULATION :	CLASS B
OPERATING TEMPERATURE:	-25°C to 60°C
SPEED CONTROL	CONTROL INPUT 0~10VDC / PWM
LIFE EXPECTANCE	50,000 Hours at At 40°C
SIGNAL OUTPUT	FG (Frequency Generator)
RoHS COMPLIANCE	Yes.
IP LEVEL	IP55 (Special IP Rating On Request)



### SPECIFICATION

MODEL NO.	RATED VAC	OPERATED VOLTAGE (VAC)	SPEED (RPM)	RATED CURRENT (A)	INPUT POWER (W)	Max. M <sup>3</sup> /H	Air Flow CFM	Max. Static inch-H <sub>2</sub> O	Pressure PA	Noise Level dB(A)
ECFK16575V2HB-PB	230	184~270	4450	0.25	34	280	164.78	2.00	500	65

### DRAWING:

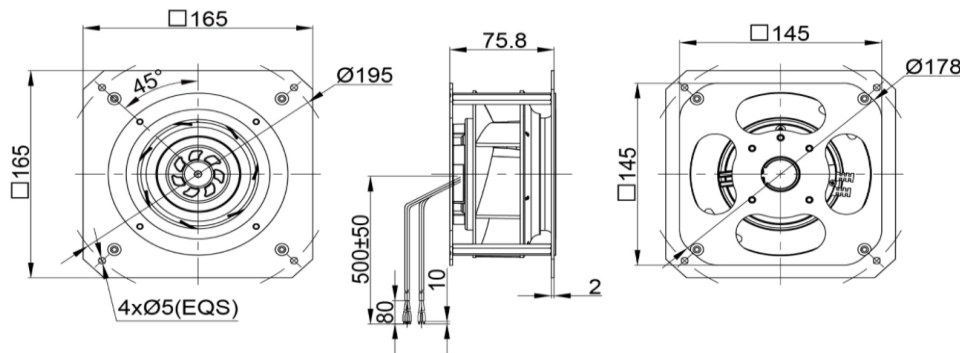

### PQ CURVE:

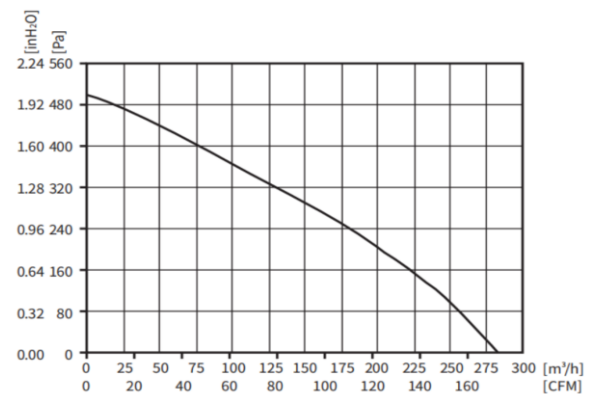

Specifications are subject to change without notice. Please visit our website at <http://www.sofasco.com> for update information.