

133mm BACKWARD CURVED CENTRIFUGAL FANS WITH SUPPORT BRACKET

INFORMATION

IMPELLER:	PA66+GF
BLADE NO.:	7 BLADES
BEARING:	NMB BALL BEARING
LEAD WIRES	AC (AWG20#), DC (AWG24#)
INSULATION :	CLASS B
OPERATING TEMPERATURE:	-25°C to 60°C
SPEED CONTROL	CONTROL INPUT 0~10VDC / PWM
LIFE EXPECTANCE	50,000 Hours at At 40°C
SIGNAL OUTPUT	FG (Frequency Generator)
RoHS COMPLIANCE	Yes.
IP LEVEL	IP55 (Special IP Rating On Request)



SPECIFICATION

MODEL NO.	RATED VAC	OPERATED VOLTAGE (VAC)	SPEED (RPM)	RATED CURRENT (A)	INPUT POWER (W)	Max. M ³ /H	Air Flow CFM	Max. Static inch-H ₂ O	Pressure PA	Noise Level dB(A)
ECFK165122V2HB-PB	230	184~270	4400	0.30	43	415	244.23	1.80	450	70

DRAWING:

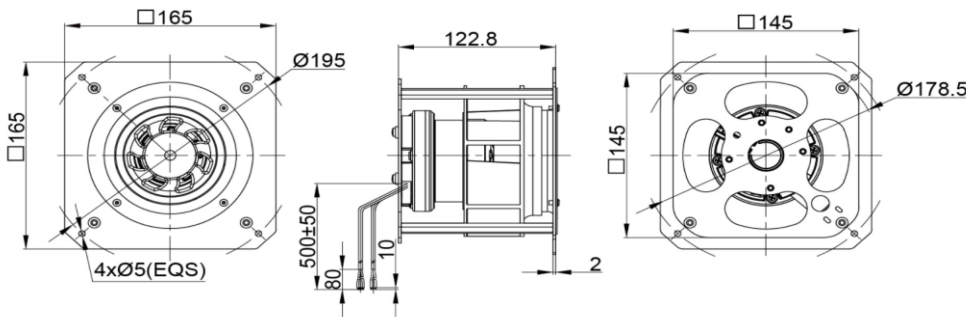

PQ CURVE:

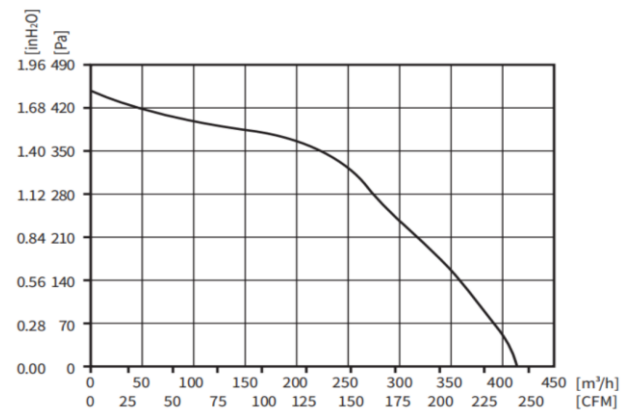

Specifications are subject to change without notice. Please visit our website at <http://www.sofasco.com> for update information.