

ComfoWell 220

Modular manifold for use with semi-rigid ductwork

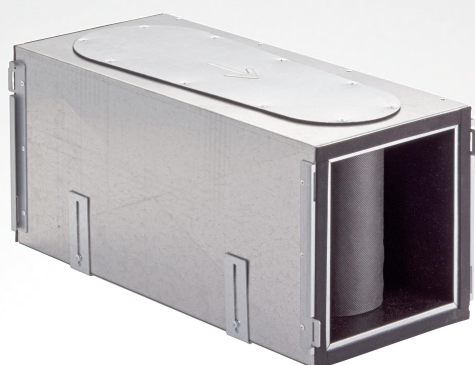

ComfoWell 220

The Zehnder ComfoWell 220 is a modular system consisting of attenuators, fine grade filters and active carbon filters all integrated for use with a rigid or semi-rigid ductwork approach. With a width of 220 mm it can be used for connecting up to 4 ComfoTube connections. The systems compact dimensions ensure good sound absorption and also make it easy to clean. Rigid pipe can be connected to the end plate securely by utilising the gasket seal connection. All other components are fitted using the locking slide connections to form an air tight and robust seal.

Noise reduction can be improved by combining two attenuators together. Filters are available in ISO ePM1 >80% (F7) or ISO ePM1 >90% (F9) grade in addition to an odour neutralising active carbon filter.



Key Features

- Attenuator, fine grade filter, active carbon filter and manifold all combined into one space saving combination with the option to bespoke build exactly what's required.
- Easy to assemble thanks to its modular and compact design.

Article Numbers

Description	Product Code
Attenuator Zehnder ComfoWell attenuator, CW-S 220	990 323 500
Manifold Zehnder ComfoWell manifold box, CW-D 220	990 323 530
Filter Housing Zehnder ComfoWell filter housing, CW-F 220	990 323 550
Mounting Plates Zehnder ComfoWell mounting plate, CW-M 220, 4 x 75 mm connections	990 323 610
Zehnder ComfoWell mounting plate, CW-M 220, 4 x 90 mm connections	990 323 611
End Plates Zehnder ComfoWell end plate, CW-P 220, ø 125 mm	990 323 510
Zehnder ComfoWell end plate, CW-P 220, ø 150 mm	990 323 563
Spacer Frame Zehnder ComfoWell spacer frame, CW-DF 220	990 323 537
Mounting Set Zehnder ComfoWell mounting set, CW-K 220, for Zehnder ComfoAir 160	990 323 569
Zehnder ComfoWell connection plate, CW-P DK 220, for Zehnder ComfoAir 180 downward supply spigot	990 323 577
Filters Filter for ComfoWell 220, CW-F7 220, ISO ePM1 >80% (F7), 1 Piece	990 323 600
Filter for ComfoWell 220, CW-F9 220, ISO ePM1 >90% (F9), 1 Piece	990 323 601
Filter for ComfoWell 220, CW-AC 220, active carbon filter, 1 Piece	990 323 602

Technical Specification

Housing	Galvanised sheet steel
Inner lining	Closed-cell melamine resin foam
Operating temperature range	-25 to +60°C
Recommended maximum air volume	44.4 l/s (160 m³/h) at normal ventilation level
Air tightness class to EN 1507:2006	B
Air tightness class to EN 12237:2003	B
Fire rating to EN 13501-1	C

Pressure Curve

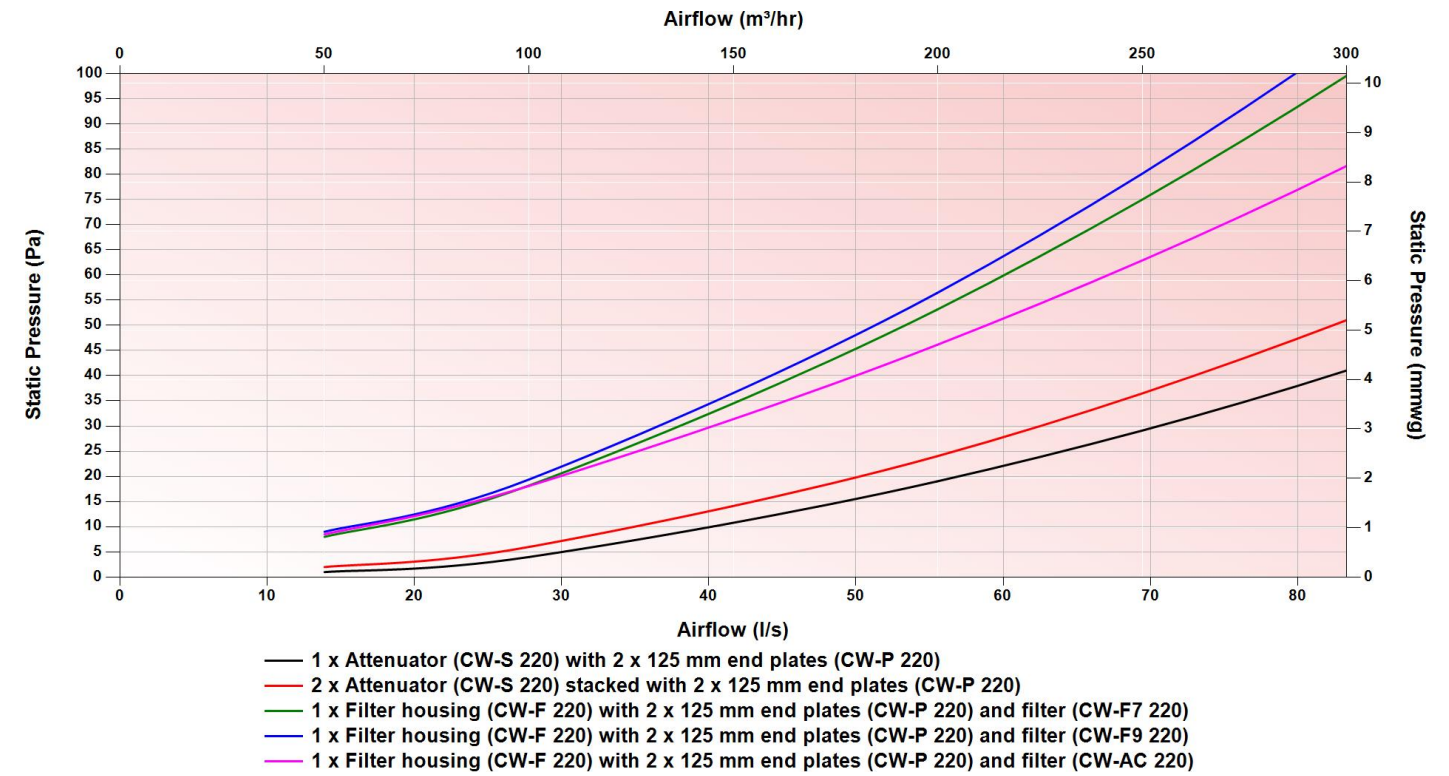





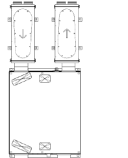

Sound Data

Combination	Octave Band (Hz) Insertion Loss, dB							
	63	125	250	500	1000	2000	4000	8000
1 x Attenuator (CW-S 220) with 2 x 125 mm end plates (CW-P 220)	5,9	10,2	11,1	16,3	14,8	32,2	25,8	28,1
2 x Attenuator (CW-S 220) stacked with 2 x 125 mm end plates (CW-P 220)	7,8	19,4	18,6	28,7	26,5	51,5	45,0	39,1

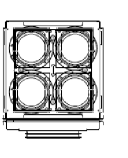
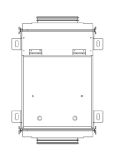
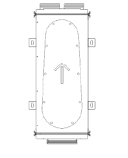
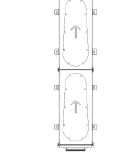
Acoustic performance measured according to EN ISO 7235 (pink noise)

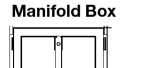
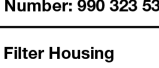
Example Connections

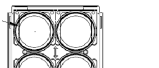
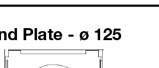
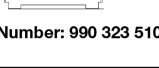
Combination Options	ComfoAir 160 right handed (factory setting) with mounting set, 2 x attenuators and 2 x 6 port ø 75mm mounting plates	Stand alone attenuator with 2 x ø 125mm end plates	Stand alone manifold with 1 x ø 125mm end plate and 4 x ø 75mm mounting plate	Stand alone filter housing with 2 x ø 125mm	Stand alone silencer and manifold combined with 1 x ø 125mm end plate and 4 x ø 75mm mounting plate	Stand alone 2 x attenuator with 1 x ø 125mm end plate and 4 x ø 75mm mounting plate
Individual Components						
Silencer  Article Number: 990 323 500	2 x Zehnder ComfoWell attenuator, CW-S 220	1 x Zehnder ComfoWell attenuator, CW-S 220	—	—	1 x Zehnder ComfoWell attenuator, CW-S 220	2 x Zehnder ComfoWell attenuator, CW-S 220
Manifold Box  Article Number: 990 323 530	—	—	1 x Zehnder ComfoWell manifold box, CW-D 220	—	—	—
Filter Housing  Article Number: 990 323 550	—	—	—	1 x Zehnder ComfoWell filter housing, CW-F 220	—	—
Mounting Plate -ø 75  Article Number: 990 323 610	2 x Zehnder ComfoWell mounting plate, CW-M 220, 4 x 75mm connections	—	1 x Zehnder ComfoWell mounting plate, CW-M 220, 4 x 75mm connections	—	1 x Zehnder ComfoWell mounting plate, CW-M 220, 4 x 75mm connections	1 x Zehnder ComfoWell mounting plate, CW-M 220, 4 x 75mm connections
End Plate - ø 125  Article Number: 990 323 510	—	2 x Zehnder ComfoWell end plate, CW-P 220, ø 125mm	1 x Zehnder ComfoWell end plate, CW-P 220, ø 125mm	2 x Zehnder ComfoWell end plate, CW-P 220, ø 125mm	1 x Zehnder ComfoWell end plate, CW-P 220, ø 125mm	1 x Zehnder ComfoWell end plate, CW-P 220, ø 125mm
Mounting Set  Article Number: 990 323 569	1 x Zehnder ComfoWell mounting set, CW-K 220, for Zehnder ComfoAir 160	—	—	—	—	—
Filter  Article Number: 990 323 601	—	—	—	1 x Filter for ComfoWell 220, CW-F (220, ISO ePM1 > 90% (F9), 1 piece	—	—

Zehnder ComfoWell attenuator CW-S 220

Article number: 990 323 500

Description

Attenuator:

Zehnder ComfoWell attenuator CW-S 220. Rectangular compact attenuator with highly efficient sound insulation combined with low pressure losses. The attenuator can be used individually or in combination with all ComfoWell components. The airtight connection between components is via a clamping strip. For cleaning purposes the sound absorbing element can be removed. Mounting on the wall or ceiling is done using the supplied fully adjustable installation mounts.

Technical Specification

Height	506 mm
Width	236 mm
Depth	232.5 mm
Weight	5.1 kg

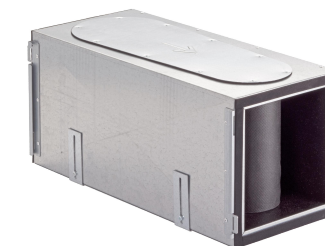

Dimensions

Front View

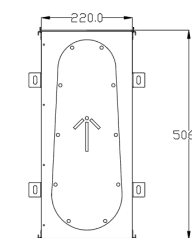

Side View

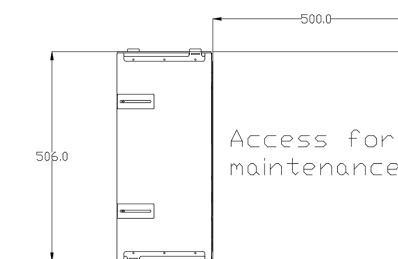

Top View

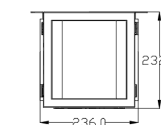

Zehnder ComfoWell manifold box CW-D 220

Article number: 990 323 530

Description

Manifold Box:

Zehnder ComfoWell manifold box CW-D 220. Rectangular compact design with closed pore internal lining. Suitable for use with the mounting plate for 4 x ComfoTube 75 mm connections or 4 x 90 mm connections. The mounting plate can be mounted on the top or side of the manifold box. The airtight connection between components is via a clamping strip. For cleaning purposes the manifold box side plate can be removed for easy access. Mounting on the wall or ceiling is done using the supplied fully adjustable installation mounts.

Technical Specification

Height	232.8 mm
Width	236 mm
Depth	253.8 mm
Weight	3.51 kg



Dimensions

Front View

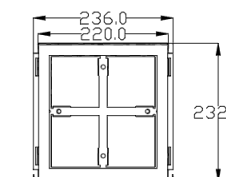

Side View

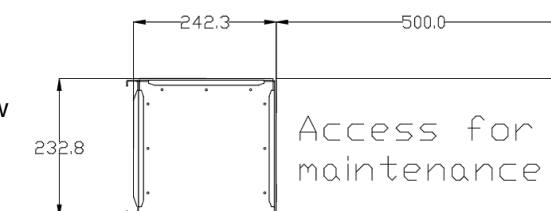

Top View

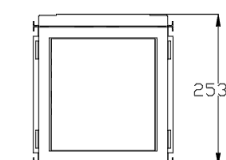

Zehnder ComfoWell filter housing CW-F 220

Article number: 990 323 550

Description

Filter Housing:

Zehnder ComfoWell filter housing CW-F 220. Rectangular compact design for use with a fine pollen filter graded ISO ePM1 >80% (F7), a fine dust filter graded ISO ePM1 >90% (F9) or an active carbon filter to neutralise odours in the supply air duct run. The filter elements are not included with the filter housing and need to be purchased separately. The filter housing can be used individually or in combination with all ComfoWell components. The airtight connection between components is via a clamping strip. Mounting on the wall or ceiling is done using the supplied fully adjustable installation mounts.

Technical Specification

Height	306 mm
Width	236 mm
Depth	242.2 mm
Weight Housing	4.25 kg
CW-F7	0.4 kg
CW-F9	0.4 kg
CW-AC	0.66 kg



Dimensions

Front View

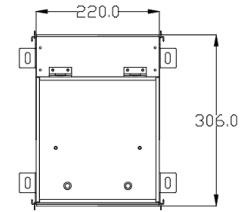

Side View

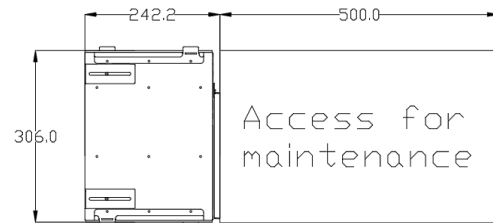

Top View

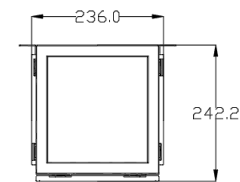

Zehnder ComfoWell mounting plate CW-M 220

Article number: 990 323 610 / 990 323 611

Description

Mounting Plate:

Zehnder ComfoWell mounting plate CW-M 220-4 x 75 or 90. Manifold mounting plate for connection of 4 x ComfoTube 75 mm or 90 mm semi-rigid ducting. The mounting plate includes a protective film and the necessary mounting accessories including locking slides.

Technical Specification

Height	45.1 mm
Width	236 mm
Depth	230 mm
Weight	<0.73 kg

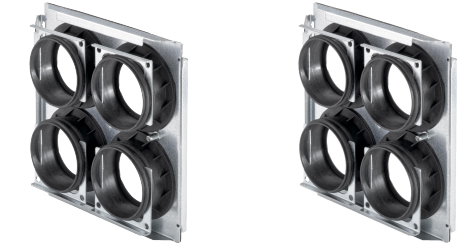

Dimensions

990 323 610
Front View

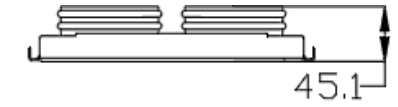

990 323 610
Side View

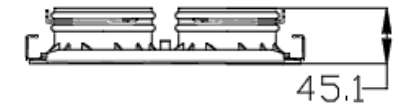

990 323 610
Top View

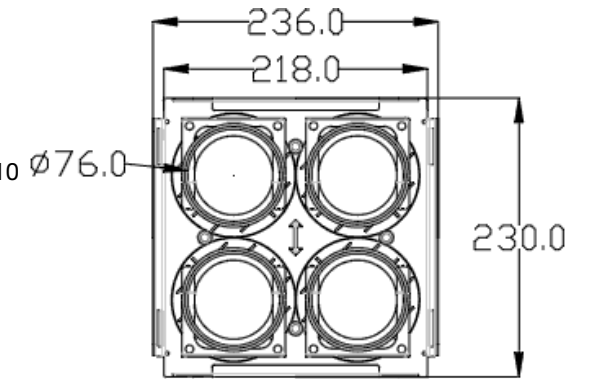

990 323 611
Front View

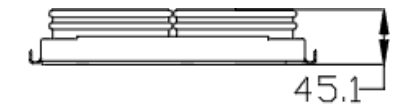

990 323 611
Side View

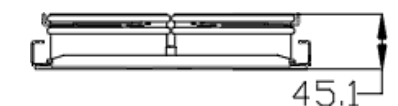

990 323 611
Top View

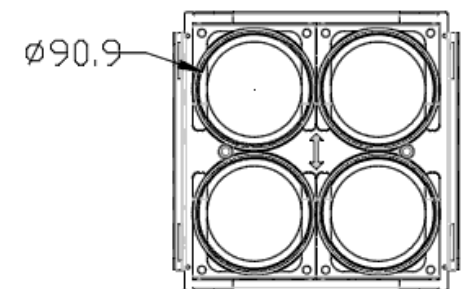

Zehnder ComfoWell end plate CW-P 220 - ø 125 / 150 mm

Article number: 990 323 510 / 990 323 563

Description

End Plate:

Zehnder ComfoWell end plate CW-P 220 - DN125 / DN150 (with centre connection) for the connection to the ComfoWell attenuator/manifold box or filter housing to the matching ducting size required. The end plate includes the necessary mounting accessories.

Technical Specification

Diameter	125 mm / 150 mm
Height	42.3 mm
Width	236 mm
Depth	230 mm
Weight	<0.73 kg



Dimensions

990 323 510
Front View

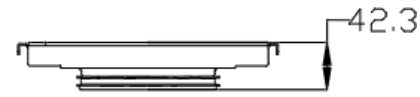

990 323 510
Side View

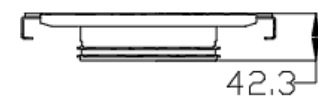

990 323 510
Top View

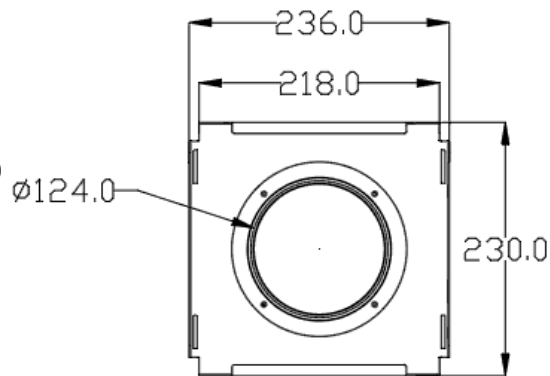

990 323 563
Front View



990 323 563
Side View



990 323 563
Top View

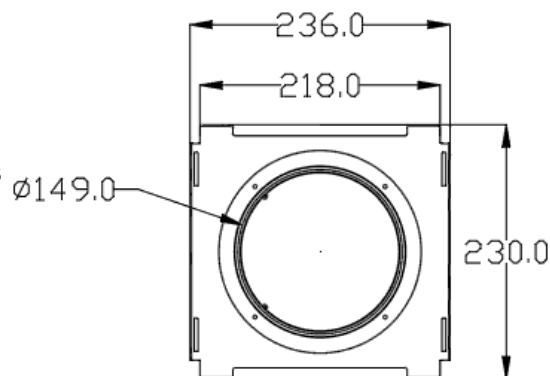

Zehnder ComfoWell spacer frame, CW-DF 220

Article number: 990 323 537

Description

Spacer Frame:

Zehnder ComfoWell spacer frame CW-DF220. Rectangular frame for use in the event of uneven surfaces when connecting components and mounting plate (concreted in place) are at 90 degrees. The spacer frame includes the necessary mounting accessories.

Technical Specification

Height	27.8 mm
Width	236 mm
Depth	230 mm
Weight	0.84 kg



Dimensions

Front View



Side View

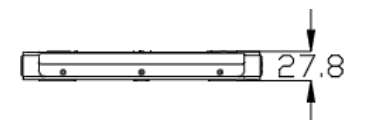

Top View

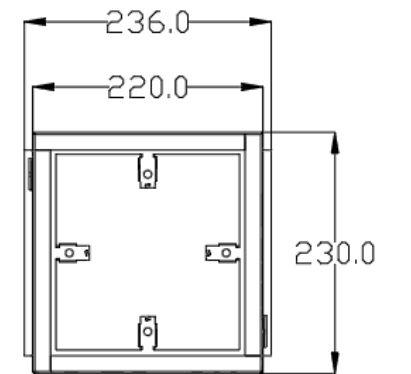

Zehnder ComfoWell mounting set, CW-K 220, for Zehnder ComfoAir 160

Article number: 990 323 569

Description

Mounting set:

A special mounting set is available for the Zehnder ComfoWell 220 for direct mounting to the ComfoAir 160 ventilation unit. The mounting set includes all the necessary accessories (screws, brackets and mounting brackets).

Technical Specification

Height	94.3 mm
Width	236 mm
Depth	230 mm
Weight	1.7 kg



Dimensions

Front View



Side View

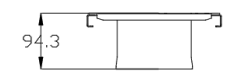

Top View

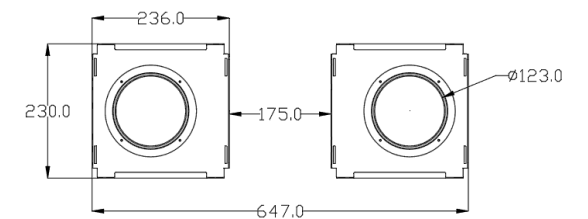

Zehnder ComfoWell connection plate, CW-P DK 220, for Zehnder ComfoAir 180 downward supply spigot

Article number: 990 323 577

Description

Mounting set:

A special mounting set is available for the Zehnder ComfoWell 220 for direct mounting to the ComfoAir 160 ventilation unit. The mounting set includes all the necessary accessories (screws, brackets and mounting brackets).

Technical Specification

Height	42.3 mm
Width	236 mm
Depth	230 mm
Weight	0.7 kg



Dimensions

Front View

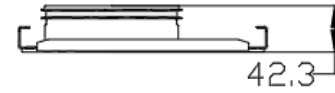

Top View

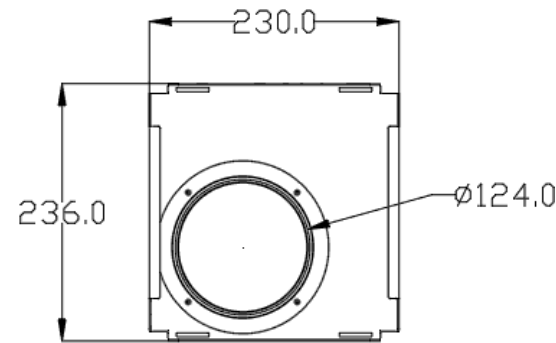

For use with

Our range of Comfowell units can be used in conjunction with our Zehnder ComfoTube \varnothing 75 mm and \varnothing 90 mm semi-rigid ductwork.



TO VIEW OUR COMFOTUBE INFORMATION

CLICK HERE

BIM/CAD Components

If you would like to download the BIM / CAD files for this or any other of our products then please visit our BIM library.

TO VISIT OUR BIM/CAD LIBRARY

CLICK HERE

Installation Instructions

If you would like to download the installation files for this or any other of our products then please visit our download page by clicking the link below.

TO VISIT OUR DOWNLOAD PAGE

CLICK HERE

Consultant Specification

Specification

The semi-rigid ductwork manifold shall be constructed of galvanised sheet steel with a closed-cell melamine resin foam inner lining to prevent dust collection and have a fire class C according to EN ISO13501.

It shall be of modular construction with options to combine attenuators, manifold box, filter housing with ISO ePM1 >80% (F7), ISO ePM1 >90% (F9) or active carbon filters and end plates ranging from \varnothing 125 mm to \varnothing 200 mm.

It shall have the option of a mounting set for direct connection to the mechanical ventilation with heat recovery unit.

The components shall be tested to BS EN 1507:2006 and BS EN 12237:2003 for airtightness and have removable elements to provide access for cleaning.