

- 15 Push one end of the flexiduct through the ceiling and attach it to the fan unit using one of the ties provided.
- 16 Mark and plug three holes using the three fixing holes on the light unit, secure by using three No. 6 countersunk screws (supplied).
- 17 Alternatively use the 2x ceiling fixing clips on the unit, these are used by first slightly unscrewing the two long screws provided so that the clips are loose.
- 18 Twist the 2x ceiling fixing clips around so that they rotate outwards. Then tighten them against the ceiling (do not overtighten). Fit lamp.
- 19 Replace internal grille onto light unit body.

Wiring Details

WARNING:

- Isolate electricity supply before starting work.
 - Installation or disconnection must be carried out by a qualified Electrician and all wiring must conform to IEE Wiring or local Regulations. Fan must only be connected using flexible supply cord.
 - The light unit is double insulated and does not require an earth connection.
 - The units must be connected to a double pole isolating switch having contact separation of at least 3mm at each pole and fitted with a 3 amp fuse.
 - When supplied from a 6 amp lighting circuit, no local fuse is required.
 - The LED Driver must be sited within a dry location and not within reach of a person using a bath or shower nor within a shower cubicle/enclosure.
 - Connect only one light unit per LED Driver..
- DO NOT OPERATE LIGHT WITHOUT FAN RUNNING.

Fan Specification

Voltage: 230V/240V~50Hz.

Power Consumption:

Cable sizes:

Timer model - 16W

Fixed wiring

(Plus 6W when light fitting added)

2 core 1mm² 3 core 1/1.5mm²

IP44

LED Lamp Specification

SELV 12V~50Hz 6W LED Lamp, Type MR16 [GU5.3]

LED Lamp fitting and replacement WARNING:

- Isolate electricity supply before starting work.
- Remove LED lamp by pulling down.
- Fit LED lamp by pushing upwards into the lamp holder.
- Push up internal grille.

Wiring Diagrams

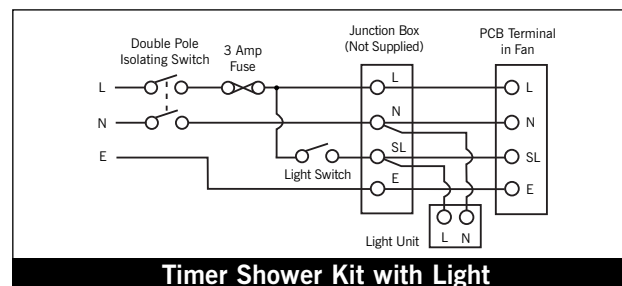
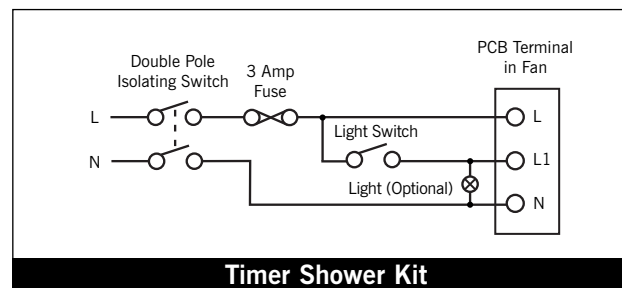

WEEE Statement

This product may not be treated as household waste. Instead it should be handed to an appropriate collection point for the recycling of electrical and Electronic equipment.

For more detailed information about the recycling of this product, please contact your local council office or your household waste disposal service.

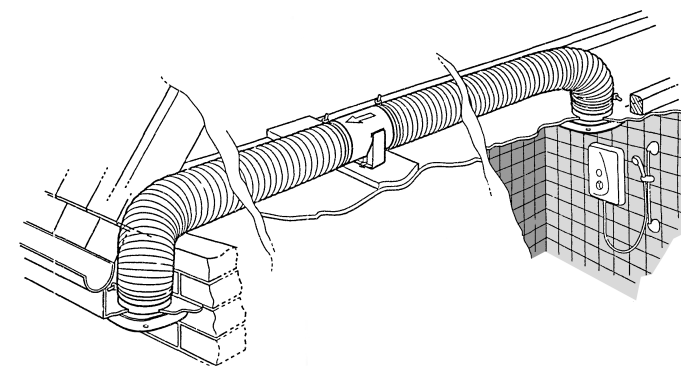

Timer Silent Shower Kit Without / With Light

Zehnder (Retail) - A Division of Zehnder Group UK Ltd
Watchmoor Point, Camberley, Surrey, GU15 3AD

Tel: +44 (0)1276 605800
email: retailsales@zehnder.co.uk
web: www.zehnder.co.uk

Installation Instructions

Please read these installation instructions before starting work.

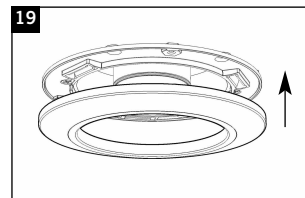
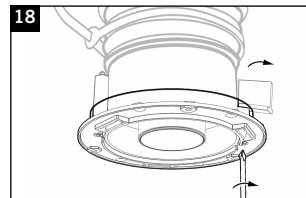
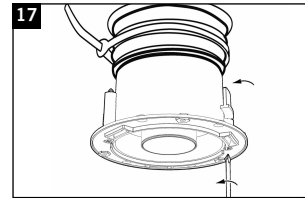
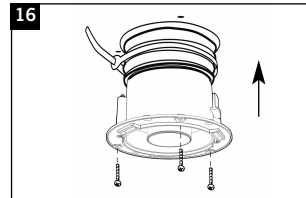
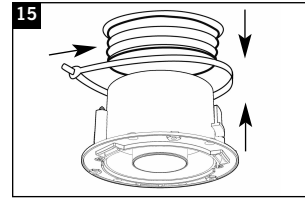
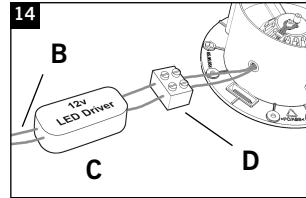
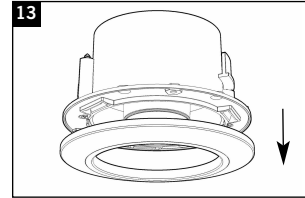
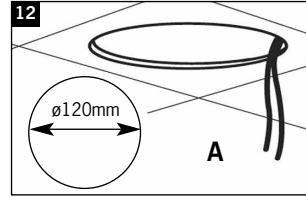
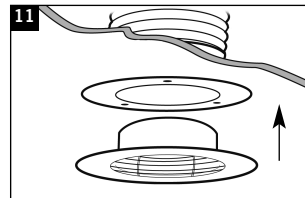
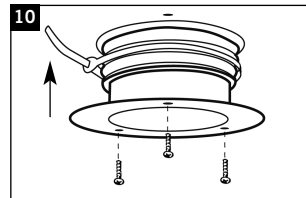
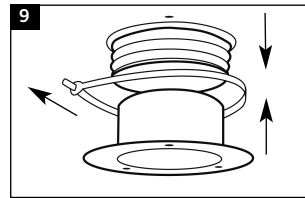
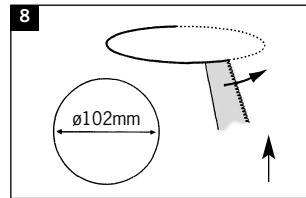
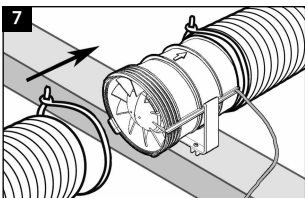
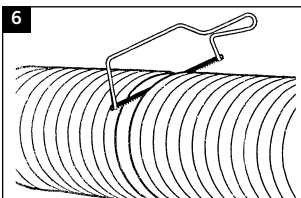
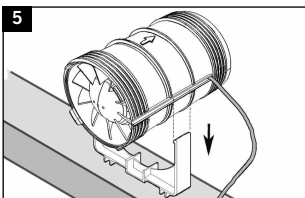
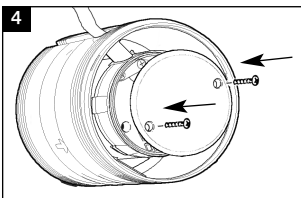
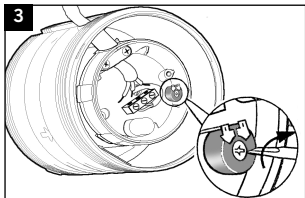
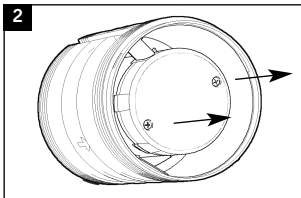
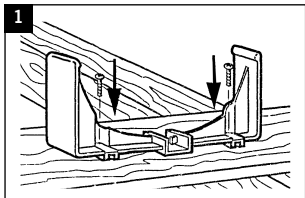
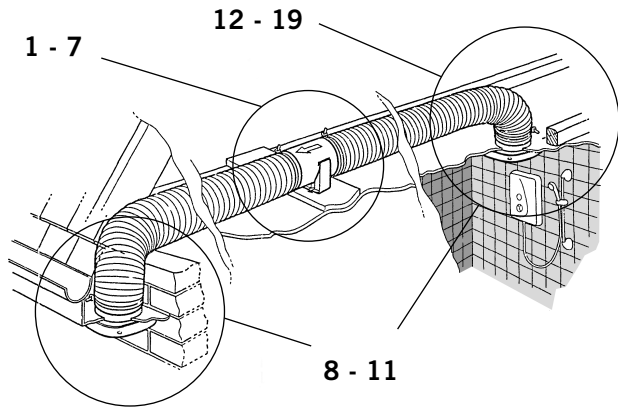

WARNING:

- ISOLATE THE FAN FROM THE MAINS SUPPLY BEFORE CARRYING OUT WORK OF ANY KIND INCLUDING ALTERING THE TIMER OVERRUN.
- This appliance can be used by children aged from 8 years and above and persons with reduced physical, sensory or mental capabilities or lack of experience and knowledge if they have been given supervision or instruction concerning use of the appliance in safe way and understand the hazards involved. Children shall not play with the appliance.
- The light kit must be used in conjunction with a ventilation fan which produces a minimum air movement of 54m³/h through the light assembly.
- Where an open-flued oil or gas-fuelled appliance is installed, precautions must be taken to avoid a back-flow of gases into the room.
- The units should not be sited where it would be subject to a direct source of heat in excess of 40°C.
- Once fitted into ceiling void or loft space do not cover light body, fan or LED Driver with any insulating materials.
- Minimum void height when fitting into ceiling space and minimum distance for light is 200mm.
- Observe appropriate safety precautions if working on steps or ladders. Wear eye protection when breaking out wall materials etc.
- Always isolate fan from mains supply before cleaning. Do not use solvents to clean this fan. Cleaning and user maintenance shall not be made by children without supervision.

In-line Mounting

- Secure the mounting foot supplied to a suitable roof beam or similar.
- Remove 2 screws from fan motor cover and remove from fan body.
- Insert cable through cable entry point on fan body and secure with clamp. For timer model set the timer with a flat blade screwdriver. The timer is adjustable between 2 and 30 minutes. It is set at midpoint. Note: Switch off the mains electricity before adjusting controls.
- Re-assemble using 2 screws to fit PCB cover to fan body.
- Clip the fan body into the mounting foot.
- Cut the ducting.
- Place flexible ducting over the spigot of both ends of the fan body. Fit ducting to spigot using ties.
- Cut holes in ceiling and external soffit to take the grille body diameter.
- Draw ducting through holes in ceiling and soffit, fit ducting to spigot using ties.
- Secure louvre to ceiling and also to soffit. Fix with screws & wall plugs as required.
- Clip the louvre to the grille body.



Optional Light Fitting

- Cut a hole in the ceiling of the room where the light will be installed and thread through low voltage cables from LED Driver.
A = 12V LED Driver cables
- Unclip internal grille from light unit.
- Wire the unit according to model diagram.
B = From Mains Supply C = 12 Volt LED Driver
D = Pre-wired terminal block