

Zehnder ComfoTube 75mm



ComfoTube 75mm

The Zehnder ComfoTube 90mm is a high performance semi-rigid ductwork ideal for residential applications. The low profile manifolds and ductwork mean it's perfect for use in small ceiling voids and is strong enough to even be set into the building concrete structure. The clinside smooth internal lining help to reduce build up of dust and enable the ductwork to be cleaned, this has helped the ductwork achieve a hygiene certificate from the Hygiene Institute. The ductwork was also one of the first to be fully accredited and listed on the PCDB.

The ductwork can be installed much faster than conventional ductwork with a reduced number of connections helping to reduce any potential air leakage within the system. The O-rings and locking slides also help to prevent the ductwork being disconnected during first fix and maintain an airtight seal. End caps are also provided to prevent dust ingress during first fix to maintain a hygienic system.

A variety of manifolds, ancillaries and terminations can be used with the ductwork in addition to a wide range of designer grilles. The ductwork can also be used with the unique modular ComfoWell manifolds with integrated attenuators and filters.

Key Features

- Easy and quick to install
- Airtight
- High-quality food-grade polyethylene (PE)
- Fully accredited and listed on the PCDB
- Certified by the Hygiene Institute
- Low pressure losses
- Easy to clean
- Suitable for installation in the building concrete structure
- Crush resistant ring stiffness of ~12.0 kN/m²
- Corrosion resistant
- Lightweight and easy to handle
- No sealant or tape required
- Wide range of manifolds and grille terminations
- Suitable for use with the unique modular ComfoWell manifolds

Article Numbers

Description	Product Code
Ductwork	
Zehnder ComfoTube ø 75mm, 20m roll	990 328 001
Zehnder ComfoTube ø 75mm, 50m roll	990 328 007

Manifold - [See ComfoWell datasheet for all modular manifold options](#)

Plastic manifold, 1 x ø 125mm connection, 5 x ø 75mm ports	TPDB1255
Plastic manifold, 1 x ø 160mm connection, 10 x ø 75mm ports	TPDB16010
Plastic manifold, 1 x ø 180mm connection, 15 x ø 75mm ports	TPDB18015

CLD Grille housing

Grille housing CLD-P 75 frontal sleeve, height 85mm, connects 1 x ø 75mm Zehnder ComfoTube	990 320 810
Grille housing CLD-P 75 lateral sleeve, height 85mm, connects 1 x ø 75mm Zehnder ComfoTube	990 320 811
Grille housing CLD-P 75 frontal sleeve, height 115mm, connects 1 x ø 75mm Zehnder ComfoTube	990 320 812
Grille housing CLD-P 75 lateral sleeve, height 115mm, connects 1 x ø 75mm Zehnder ComfoTube	990 320 813
Grille housing CLD-P 75 frontal sleeve, height 140mm, connects 1 x ø 75mm Zehnder ComfoTube	990 320 849
Grille housing CLD-P 75 lateral sleeve, height 140mm, connects 1 x ø 75mm Zehnder ComfoTube	990 320 850

Article Numbers

TVA Grille housing

Grille housing TVA-P 75 connects 1 x ø 125mm valve to 1 x ø 75mm Zehnder ComfoTube, L167mm	990 326 001
Grille housing TVA-P 75 connects 1 x ø 125mm valve to 2 x ø 75mm Zehnder ComfoTube, L64mm	990 326 121
Grille housing TVA-P 75 connects 1 x ø 125mm valve to 2 x ø 75mm Zehnder ComfoTube, L300mm	990 326 125

CSB-P Grille housing

Rectangular grille housing CSB-P 400 connects 1 x Lamina/Bilamina/ComfoGrid 400 to 1 x ø 90mm, 2 x ø 75mm Zehnder ComfoTube	990 321 745
Rectangular grille housing CSB-P 600 connects 1 x Lamina/Bilamina/ComfoGrid 600 to 1 x ø 110mm, 2 x ø 90mm Zehnder ComfoTube	991 321 746

Ancillaries

Zehnder ComfoTube ø 75mm, adjustable airflow regulator, 30mm length	988 320 030
Zehnder ComfoTube ø 75mm, adjustable airflow regulator, 75mm length	990 320 026
Filter for ø 125mm extract air valve, ISO Coarse >45% (G3), 10 Pieces	990 320 032
Filter for CLD housing, ISO Coarse >45% (G3), 10 Pieces	990 320 573
Filter for rectangular grille housing CSB-P 400, ISO Coarse >55% (G3), 10 Pieces	990 321 768
Filter for rectangular grille housing CSB-P 600, ISO Coarse >55% (G3), 10 Pieces	990 321 769
Zehnder ComfoTube ø 90mm, manifold/grille housing spigot reducer, ø 90mm to ø 75mm	990 322 010
Zehnder ComfoFresh Flat 51 to Zehnder ComfoTube ø 75/90mm convertor	990 322 013
Zehnder ComfoTube Flat 51 to 2 x Zehnder ComfoTube ø 75mm convertor	990 322 150
Zehnder ComfoTube ø 75mm, 90° bend	990 322 152
Zehnder ComfoTube ø 75/90mm cross-piece	990 322 155
Zehnder ComfoTube ø 75mm, locking slides, 10 pieces	990 326 024
Grille housing TVA-P 75/90 mounting set for concrete application	990 326 127
Fixing bracket for CSB-P 400/600 grille housing, 2 pieces	988 321 646
90° metal bracket for max 2 Zehnder ComfoTube	990 327 109
Zehnder ComfoFix link for ComfoTube ø 75mm, 10 pieces	990 327 200
Zehnder ComfoTube ø 75mm, pipe connector	990 328 107
Zehnder ComfoTube ø 75mm, end caps, 10 pieces	990 328 262
Zehnder ComfoTube ø 90mm, end caps, 10 pieces	990 328 263
Zehnder ComfoTube ø 75mm, O-ring seal, 10 pieces	990 328 362

3D System Layout

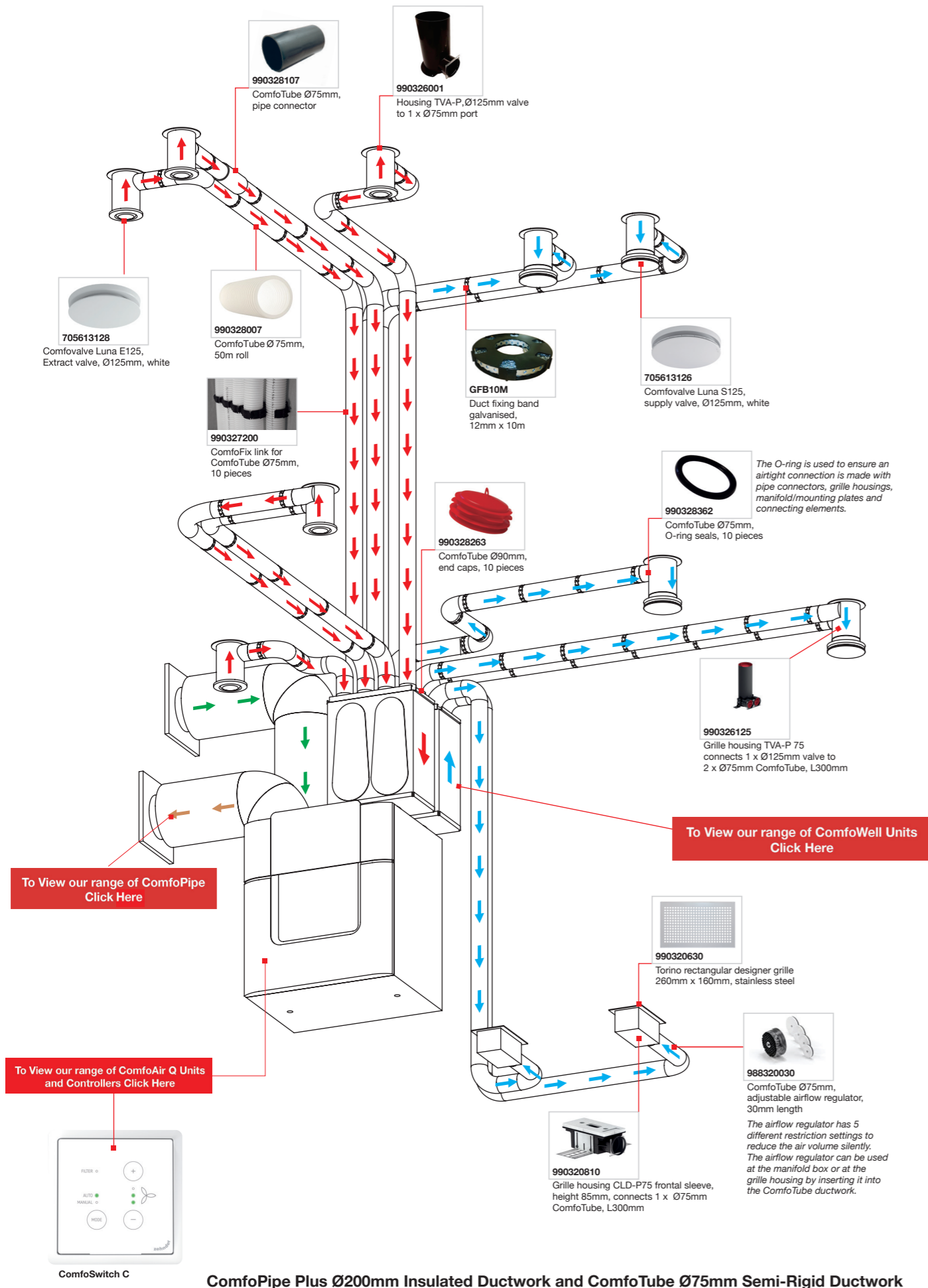

Zehnder ComfoTube ø 75mm, 20/50m roll

Article number: 990 328 001 / 990 328 007

Technical Specification

Material	High-quality food-grade polyethylene (PE)
Operating temperature range	-25 to +60 °C
Maximum recommended air volume per tube	8.3l/s (30m³/h)
Minimum bending radius	75mm
Minimum radius < 2 x diameter	Yes
Buoyancy in concrete	80 N/m
Outside diameter	75mm
Inside diameter	63mm
Weight per m	0.31 kg/m
Fire rating in accordance with EN 13501-1	E
Ring stiffness	~12.0 kN/m²
BS EN ISO 9969:2007 crushability compliant	Yes
Coil diameter (50m roll)	1180mm
Coil height (50m roll)	390mm

Pressure Curve

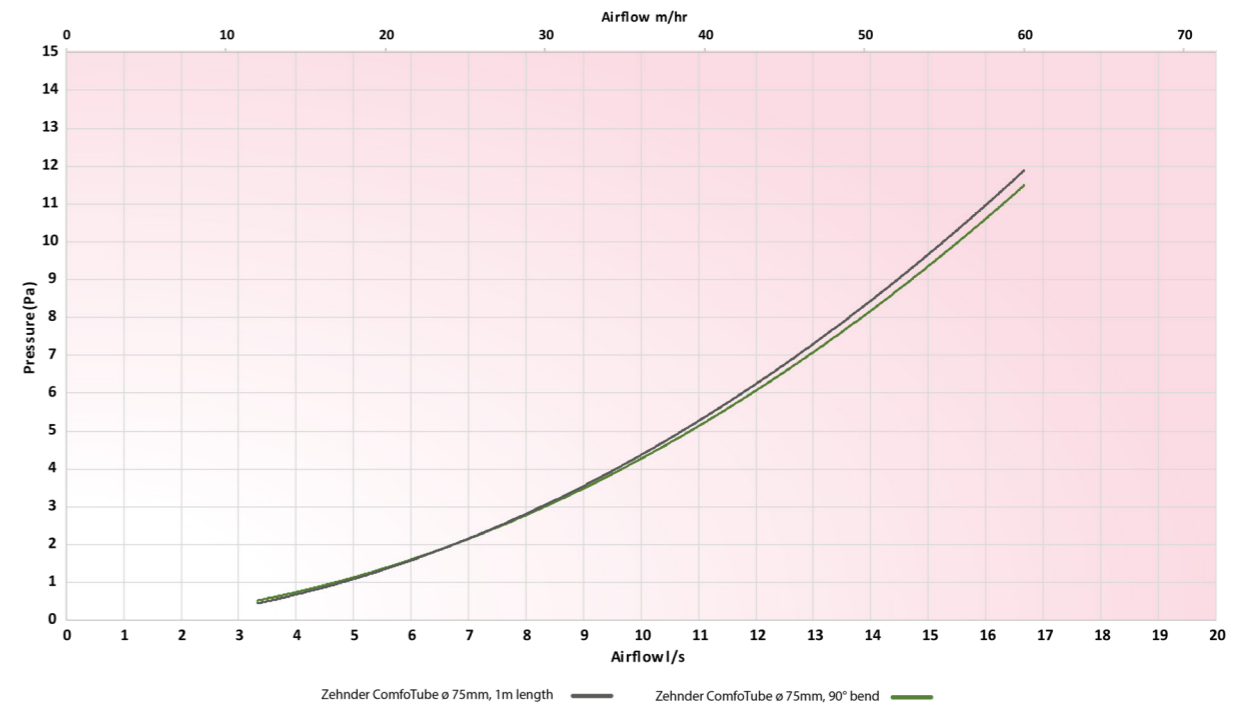

Sound Data

	Octave Band (Hz) Insertion Loss, dB							
	63	125	250	500	1000	2000	4000	8000
Zehnder ComfoTube ø 75mm, 1m length	0.4	0.6	0.4	0.2	0.3	1		

Acoustic performance measured according to EN ISO 7235 (pink noise)

■ For use with Zehnder ComfoWell, Manifolds and Grille housings.

Plastic manifold, 1 x \varnothing 125mm connection, 5 x \varnothing 75mm ports

Article number: TPDB1255

Description

Manifold:
Plastic anti-static manifold. Rectangular compact design. Suitable for use with the Zehnder ComfoTube \varnothing 75mm semi-rigid ductwork and comes complete with locking slides.

The mounting plate can be mounted on the top or front of the manifold. For cleaning purposes the manifold plate can be removed for easy access. Mounting on the wall or ceiling is done using the premoulded fixing holes.

Technical Specification

Height	136mm
Width	644mm
Depth	623mm
Weight	5.8 kg
Material	High-density polyethylene (HDPE)
Operating temperature range	-10°C to +70°C

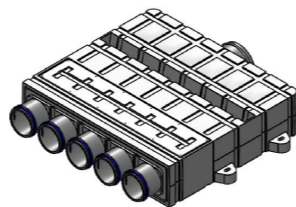

Dimensions

Side view



Front view

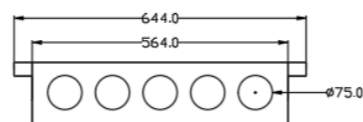

Top View

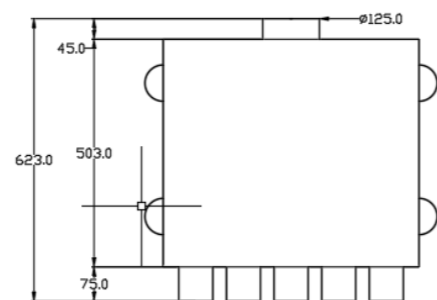

Pressure Curve

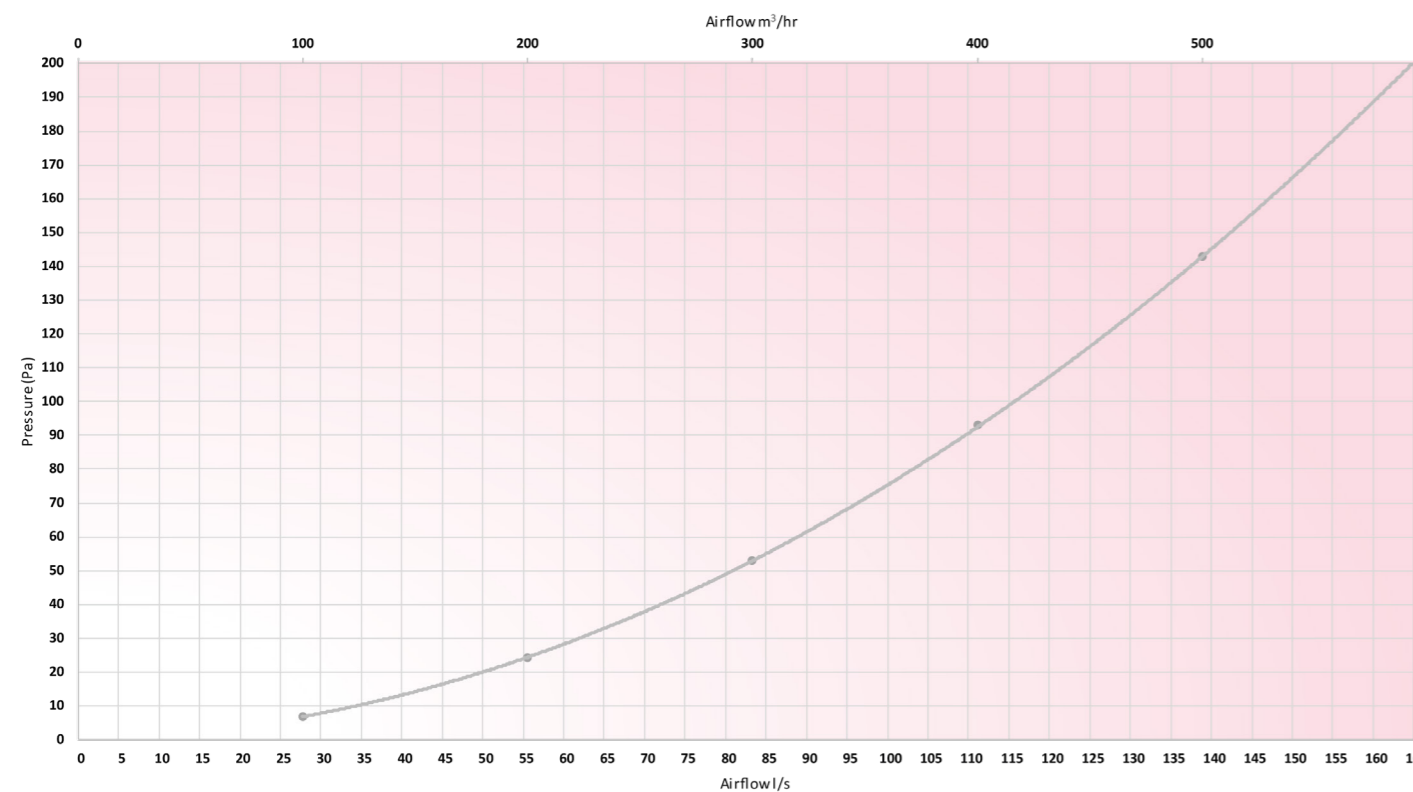

Plastic manifold, 1 x \varnothing 125mm connection, 5 x \varnothing 75mm ports

■ For use with Zehnder ComfoTube \varnothing 75mm semi-rigid ductwork.

Plastic manifold, 1 x \varnothing 160mm connection, 10 x \varnothing 75mm ports

Article number: TPDB16010

Description

Manifold:
Plastic anti-static manifold. Rectangular compact design. Suitable for use with the Zehnder ComfoTube \varnothing 75mm semi-rigid ductwork and comes complete with locking slides.

The mounting plate can be mounted on the top or front of the manifold. For cleaning purposes the manifold plate can be removed for easy access. Mounting on the wall or ceiling is done using the premoulded fixing holes.

Technical Specification

Height	239mm
Width	642mm
Depth	626mm
Weight	8 kg
Material	High-density polyethylene (HDPE)
Operating temperature range	-10°C to +70°C

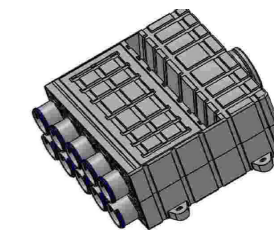

Dimensions

Side view

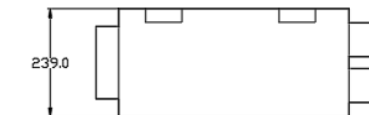

Front view

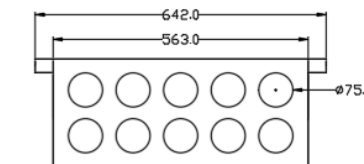

Top View

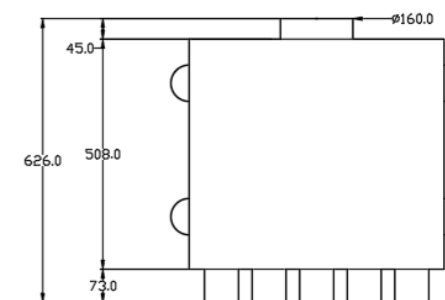

Pressure Curve

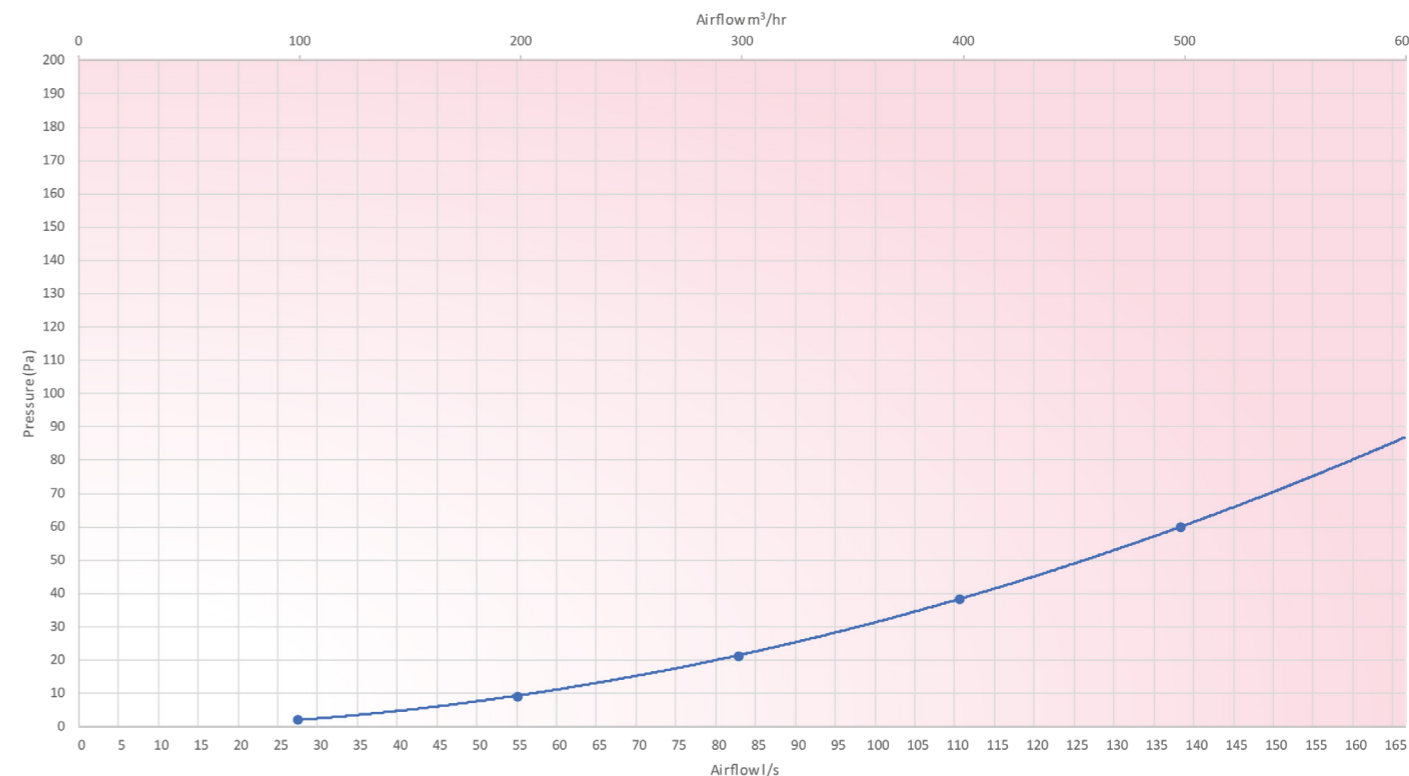

Plastic manifold, 1 x \varnothing 160mm connection, 10 x \varnothing 75mm ports

■ For use with Zehnder ComfoTube \varnothing 75mm semi-rigid ductwork.

Plastic manifold, 1 x \varnothing 180mm connection, 15 x \varnothing 75mm ports

Article number: TPDB18015

Description

Manifold:
Plastic anti-static manifold. Rectangular compact design. Suitable for use with the Zehnder ComfoTube \varnothing 75mm semi-rigid ductwork and comes complete with locking slides.

The mounting plate can be mounted on the top or front of the manifold. For cleaning purposes the manifold plate can be removed for easy access. Mounting on the wall or ceiling is done using the premoulded fixing holes.

Technical Specification

Height	346mm
Width	642mm
Depth	635mm
Weight	9 kg
Material	High-density polyethylene (HDPE)

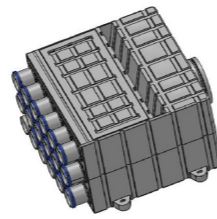

Dimensions

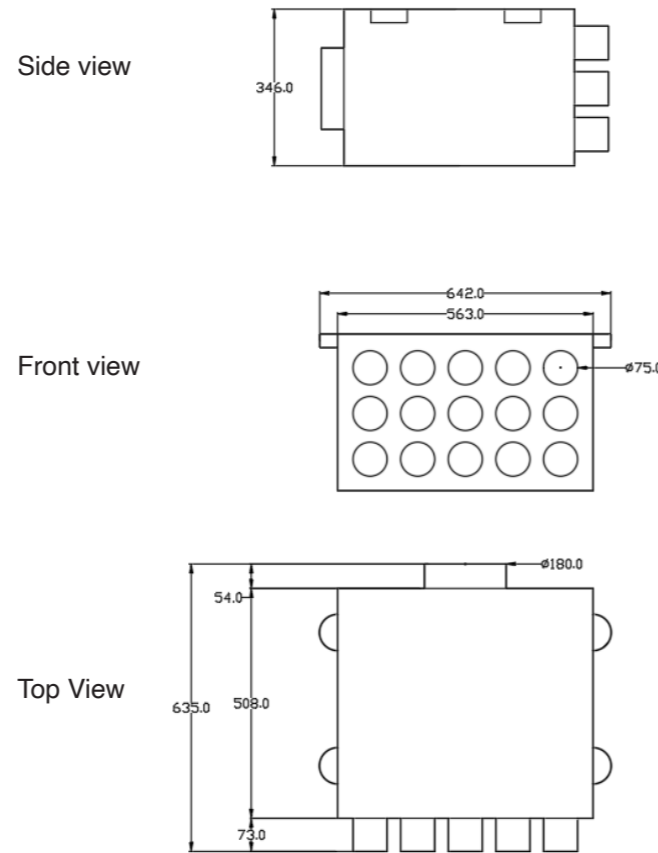

Pressure Curve

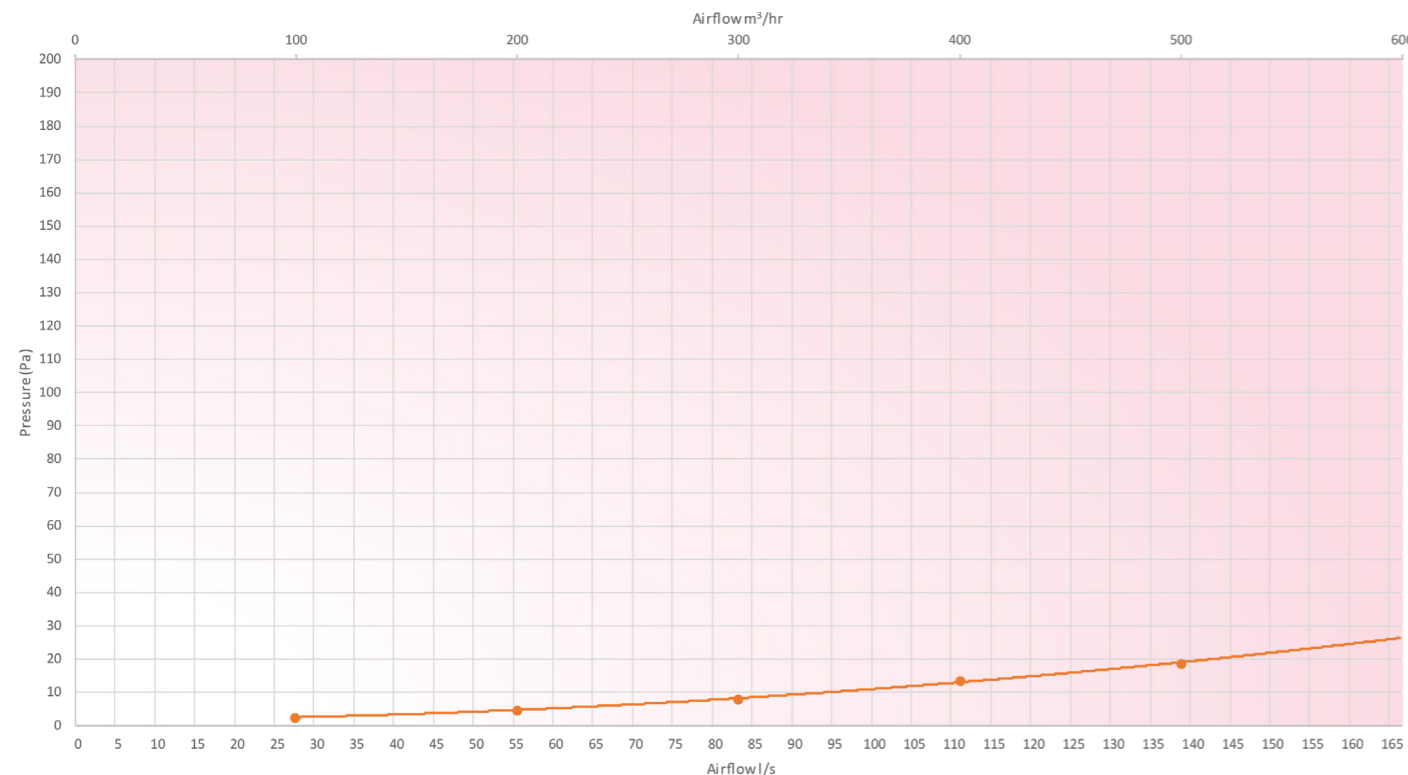

Plastic manifold, 1 x \varnothing 180mm connection, 10 x \varnothing 75mm ports

■ For use with Zehnder ComfoTube \varnothing 75mm semi-rigid ductwork.

CLD Grille housing - Frontal Sleeve 85mm

Article number: 990 320 810

Description

CLD Grille housing:
Rectangular frontal entry grille housing. The cleanable rectangular CLD grille housing is suitable for installation in all types of wall/floor/ceiling depending on the CLD height and comes complete with locking slides.

The rectangular designer grilles (300 x 200mm and 260 x 160mm) can be surface or flush-mounted dependent on preference. A [Zehnder ComfoFresh filter](#) can be used to remove particulates.

Technical Specification

Height	85mm
Width	273.5mm
Depth	144mm
Weight	<0.8kg
Material	High-density polyethylene (HDPE)

■ For use with Zehnder CLD Designer grilles.

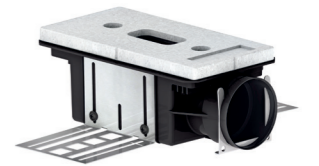

Dimensions

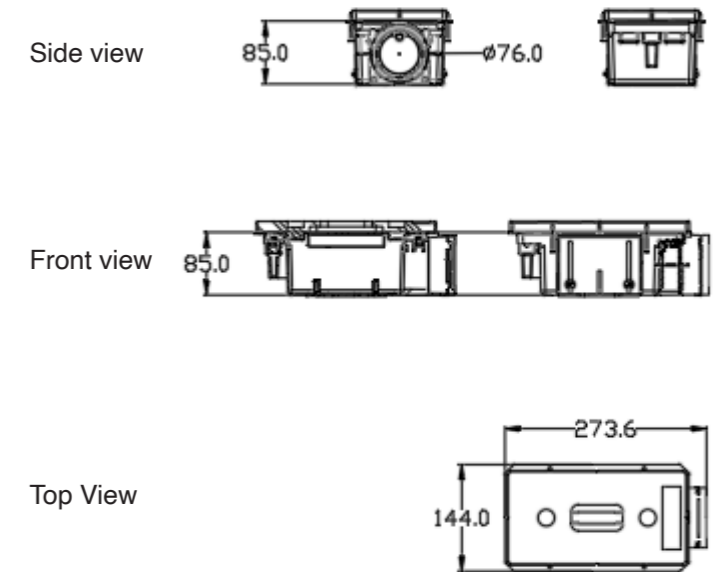

CLD Designer Grilles - Lateral Sleeve 85mm

Article number: 990 320 811

Description

CLD Grille housing:
Rectangular lateral sleeve entry grille housing. The cleanable rectangular CLD grille housing is suitable for installation in all types of wall/floor/ceiling depending on the CLD height and comes complete with locking slides.

The rectangular designer grilles (300 x 200mm and 260 x 160mm) can be surface or flush-mounted dependent on preference. A [Zehnder ComfoFresh filter](#) can be used to remove particulates.

Technical Specification

Height	85mm
Width	250mm
Depth	167.33mm
Weight	<0.8kg
Material	High-density polyethylene (HDPE)

■ For use with Zehnder CLD Designer grilles.



Dimensions

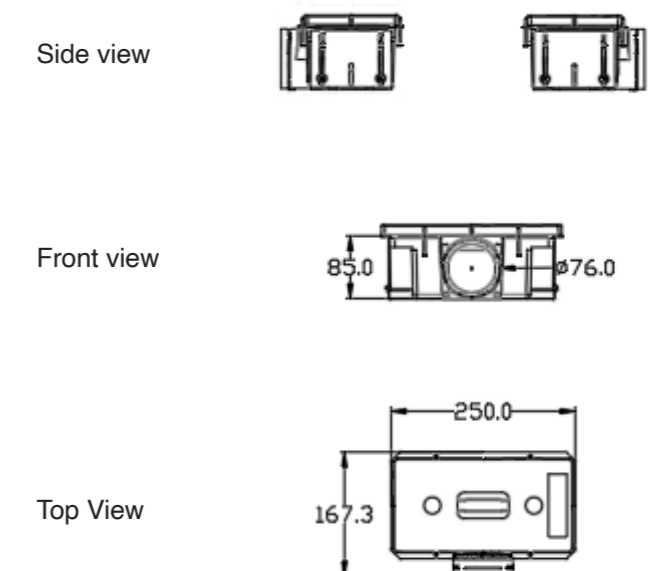

CLD Grille housing - Frontal Sleeve 115mm

Article number: 990 320 812

Description

CLD Grille housing:

Rectangular frontal entry grille housing. The cleanable rectangular CLD grille housing is suitable for installation in all types of wall/floor/ceiling depending on the CLD height and comes complete with locking slides.

The rectangular designer grilles (300 x 200mm and 260 x 160mm) can be surface or flush-mounted dependent on preference. A [Zehnder ComfoFresh filter](#) can be used to remove particulates.

Technical Specification

Height	115mm
Width	277.5mm
Depth	144mm
Weight	<0.8kg
Material	High-density polyethylene (HDPE)

■ For use with Zehnder CLD Designer grilles.

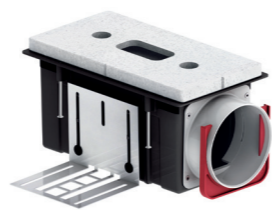

Dimensions

Side view

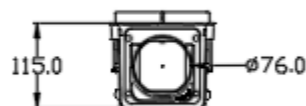

Front view

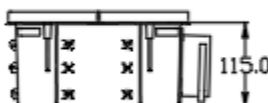

Top View

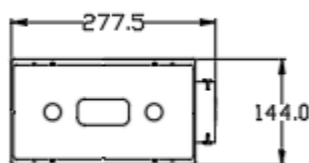

CLD Grille housing - Frontal Sleeve 140mm

Article number: 990 320 849

Description

CLD Grille housing:

Rectangular frontal entry grille housing. The cleanable rectangular CLD grille housing is suitable for installation in all types of wall/floor/ceiling depending on the CLD height and comes complete with locking slides.

The rectangular designer grilles (300 x 200mm and 260 x 160mm) can be surface or flush-mounted dependent on preference. A [Zehnder ComfoFresh filter](#) can be used to remove particulates.

Technical Specification

Height	140mm
Width	276.9mm
Depth	144mm
Weight	<0.8kg
Material	High-density polyethylene (HDPE)

■ For use with Zehnder CLD Designer grilles.



Dimensions

Side view

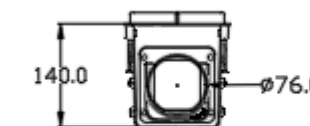

Front view

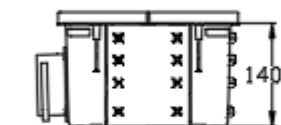

Top View

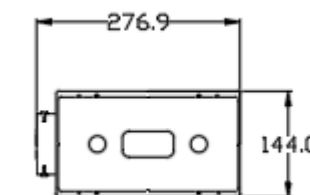

CLD Designer Grilles - Lateral Sleeve 115mm

Article number: 990 320 813

Description

CLD Grille housing:

Rectangular lateral sleeve entry grille housing. The cleanable rectangular CLD grille housing is suitable for installation in all types of wall/floor/ceiling depending on the CLD height and comes complete with locking slides.

The rectangular designer grilles (300 x 200mm and 260 x 160mm) can be surface or flush-mounted dependent on preference. A [Zehnder ComfoFresh filter](#) can be used to remove particulates.

Technical Specification

Height	115mm
Width	250mm
Depth	171.5mm
Weight	<0.8kg
Material	High-density polyethylene (HDPE)

■ For use with Zehnder CLD Designer grilles.



Dimensions

Side view



Front view

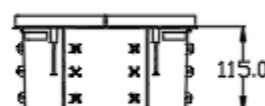

Top View

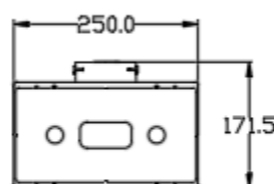

CLD Designer Grilles - Lateral Sleeve 140mm

Article number: 990 320 850

Description

CLD Grille housing:

Rectangular lateral sleeve entry grille housing. The cleanable rectangular CLD grille housing is suitable for installation in all types of wall/floor/ceiling depending on the CLD height and comes complete with locking slides.

The rectangular designer grilles (300 x 200mm and 260 x 160mm) can be surface or flush-mounted dependent on preference. A [Zehnder ComfoFresh filter](#) can be used to remove particulates.

Technical Specification

Height	140mm
Width	250mm
Depth	170.9mm
Weight	<0.8kg
Material	High-density polyethylene (HDPE)

■ For use with Zehnder CLD Designer grilles.



Dimensions

Side view

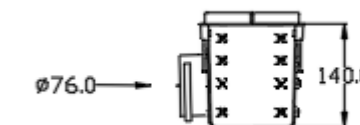

Front view

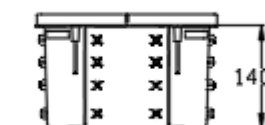

Top View

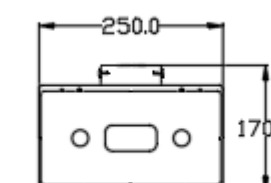

TVA Grille housing - Grille housing TVA-P 75 connects 1 x ø 125mm valve to 1 x ø 75mm Zehnder ComfoTube

Article number: 990 326 001

Description

TVA Grille housing:

Circular grille housing. The cleanable circular TVA grille housing is suitable for installation in all types of wall/ceiling depending on the height and comes complete with locking slides.

The square (160 x 160mm) and circular designer grilles can be used in addition to any standard ø 125mm valve. A [Zehnder ComfoFresh filter](#) can be used to remove particulates.

Technical Specification

Height	250mm
Spigot length	166.7mm
Width	160mm
Depth	188mm
Weight	0.5kg
Material	High-density polyethylene (HDPE)

Side view

Front view

Top View



Dimensions

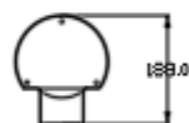
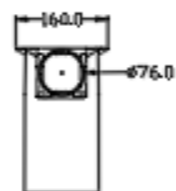
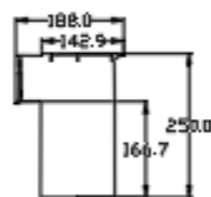

■ For use with TVA Designer grilles, ø 125mm supply/extract grilles and ComfoValve Luna

TVA Grille housing - Grille housing TVA-P 75 connects 1 x ø 125mm valve to 2 x ø 75mm Zehnder ComfoTube 64mm length

Article number: 990 326 121

Description

TVA Grille housing:

Circular grille housing. The cleanable circular TVA grille housing is suitable for installation in all types of wall/ceiling including set into concrete, depending on the height, and comes complete with locking slides. For installation into concrete the 990 326 127 mounting set is also required.

The square (160 x 160mm) and circular designer grilles can be used in addition to any standard ø 125mm valve. A [Zehnder ComfoFresh filter](#) can be used to remove particulates.

Technical Specification

Height	147mm
Spigot length	64.2mm
Width	174.5mm
Depth	178.4mm
Weight	0.38 kg
Material	High-density polyethylene (HDPE)

Side view

Front view

Top View

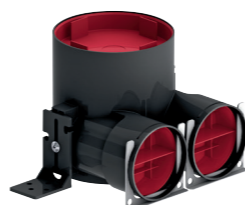

Dimensions

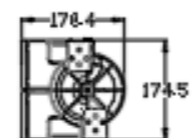

■ For use with TVA Designer grilles, ø 125mm supply/extract grilles and ComfoValve Luna

TVA Grille housing - Grille housing TVA-P 75 connects 1 x ø 125mm valve to 2 x ø 75mm Zehnder ComfoTube 300mm length

Article number: 990 326 125

Description

TVA Grille housing:

Circular grille housing. The cleanable circular TVA grille housing is suitable for installation in all types of wall/ceiling depending on the height and comes complete with locking slides.

The square (160 x 160mm) and circular designer grilles can be used in addition to any standard ø 125mm valve. A [Zehnder ComfoFresh filter](#) can be used to remove particulates.

Technical Specification

Height	383.5mm
Spigot length	300.3mm
Width	174.5mm
Depth	178.4mm
Weight	0.5 kg
Material	High-density polyethylene (HDPE)

Side view

Front view

Top View



Dimensions

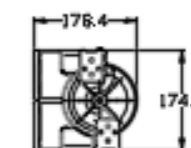
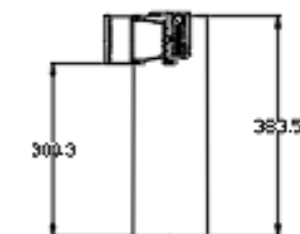

■ For use with TVA Designer grilles, ø 125mm supply/extract grilles and ComfoValve Luna

Zehnder ComfoTube ø 90mm, manifold/grille housing spigot reducer, ø 90mm to ø 75mm

Article number: 990 322 010

Description

Zehnder ComfoTube:

Zehnder ComfoTube ø 90mm to Zehnder ComfoTube ø 75mm convertor. The rigid connector can be placed into a Zehnder ComfoTube ø 90mm manifold or grille housing spigot to convert it to Zehnder ComfoTube ø 75mm and comes complete with locking slides and O-rings. Ideal for use with the CSB-P to convert 90mm spigots for use with 75mm ductwork.

Technical Specification

Length	50mm
Diameter	90.1mm
Weight	0.12kg
Material	High-density polyethylene (HDPE)

■ For use with Lamina / Bilamina 400 rectangular grilles



Rectangular grille housing CSB-P 400 connects 1 x Lamina/Bilamina/ComfoGrid 400 to 1 x \varnothing 90mm, 2 x \varnothing 75mm Zehnder ComfoTube

Article number: 990 321 745

Description

Lamina/Bilamina/ComfoGrid 400 slot diffuser housing: Rectangular lateral sleeve entry grille housing. The cleanable rectangular slot diffuser housing is suitable for installation in all types of wall/ceiling, including within concrete, depending on the height, and comes complete with locking slides. For use with 988 321 646 fixing bracket for standard ceiling mounting application. The rectangular lamina / bilamina slot diffuser can be used when used with the 20/40mm extension pins (990 320 687 / 990 320 688) and offer adjustable directional air supply. Can be used with the 90mm to 75mm reducer (990 322 010) to convert to a 3 port 75mm housing. The ComfoGrid 400 range of slot diffusers can also be used without the need for the extension pins.

Technical Specification

Height	182mm
Width	439mm
Depth	115.4mm
Weight	1.05kg
Material	High-density polyethylene (HDPE)

■ For use with Lamina/Bilamina/ComfoGrid 400 slot diffusers

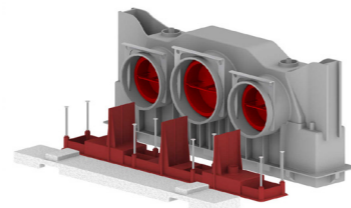

Dimensions

Side view

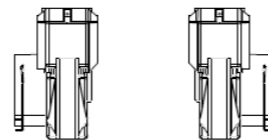

Front view

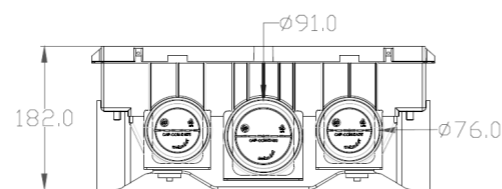

Top View

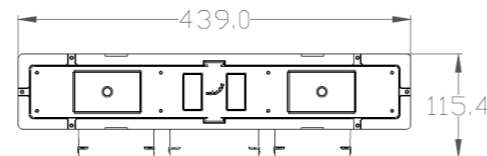

Rectangular grille housing CSB-P 600 connects 1 x Lamina/Bilamina/ComfoGrid 600 to 1 x \varnothing 110mm, 2 x \varnothing 90mm Zehnder ComfoTube

Article number: 990 321 746

Description

Lamina/Bilamina/ComfoGrid 600 slot diffuser housing: Rectangular lateral sleeve entry grille housing. The cleanable rectangular slot diffuser housing is suitable for installation in all types of wall/ceiling, including within concrete, depending on the height, and comes complete with locking slides and end caps. For use with 988 321 646 fixing bracket for mounting within wall/ceiling void. The rectangular lamina / bilamina slot diffuser can be used when used with the 20/40mm extension pins (990 320 687 / 990 320 688) and offer adjustable directional air supply. Can be used with the 90mm to 75mm reducer (990 322 010) to convert to a 2 port 75mm housing. The ComfoGrid 600 range of slot diffusers can also be used without the need for the extension pins.

Technical Specification

Height	182mm
Width	639mm
Depth	115.4mm
Weight	1.12kg
Material	High-density polyethylene (HDPE)

■ For use with Lamina/Bilamina/ComfoGrid 600 slot diffusers

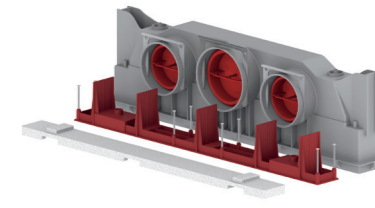

Dimensions

Side view



Front view

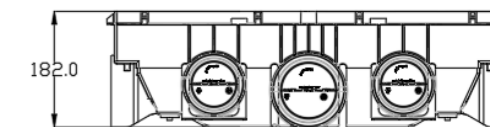

Top View

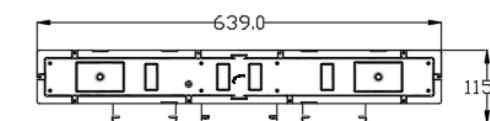

Fixing bracket for CSB-P 400/600 grille housing, 2 pieces

Article number: 988 321 646

Description

Fixing bracket: Zehnder Fixing bracket for CSB-P 400/600 grille housing. The fixing bracket is mounted to either side of the CSB-P to enable secure fixing to the wall or floor and comes complete with screws to fix to the CSB-P. These are not supplied as standard with the CSB-P.

Technical Specification

Height	163.5mm
Width	110.5mm
Depth	54mm
Weight	0.08 kg (each)
Material	Aluminium

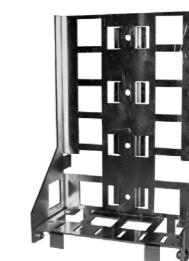

Ancillaries - Zehnder ComfoTube \varnothing 75mm, adjustable airflow regulator 75 / 30 mm Length

Article number: 990 320 026 / 988 320 030

Description

Airflow regulator:

Zehnder ComfoTube adjustable airflow regulator. The airflow regulator has 5 different restriction settings to reduce the air volume silently. The airflow regulator can be used at the manifold box or at the grille housing by inserting it into the ComfoTube ductwork.

Technical Specification

Length	75mm / 30mm
Diameter	63mm
Weight	<0.04kg
Material	Polypropylene

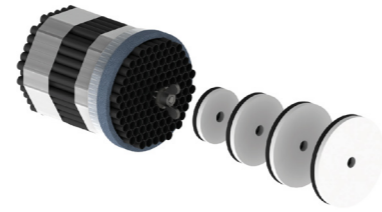

Ancillaries - Zehnder ComfoFresh filter

Article number: 990 320 032 / 990 320 573

Description

Grille housing filter:

Zehnder ComfoFresh filter for \varnothing 125mm TVA and CLD grille housing. The filter is perfect to remove particles before they enter the ductwork and is quick and easy to install without interfering with the installed parts.

Technical Specification

	990 320 032	990 320 573
Length	165mm	
Diameter	125mm	
Height		9mm
Width		113mm
Depth		174mm
Filter grade	ISO Coarse <45% (G3)	
Weight	<0.018kg each	
Material	Polyester	



■ For use with TVA and CLD designer grilles and \varnothing 125mm extract grilles

Pressure Curve

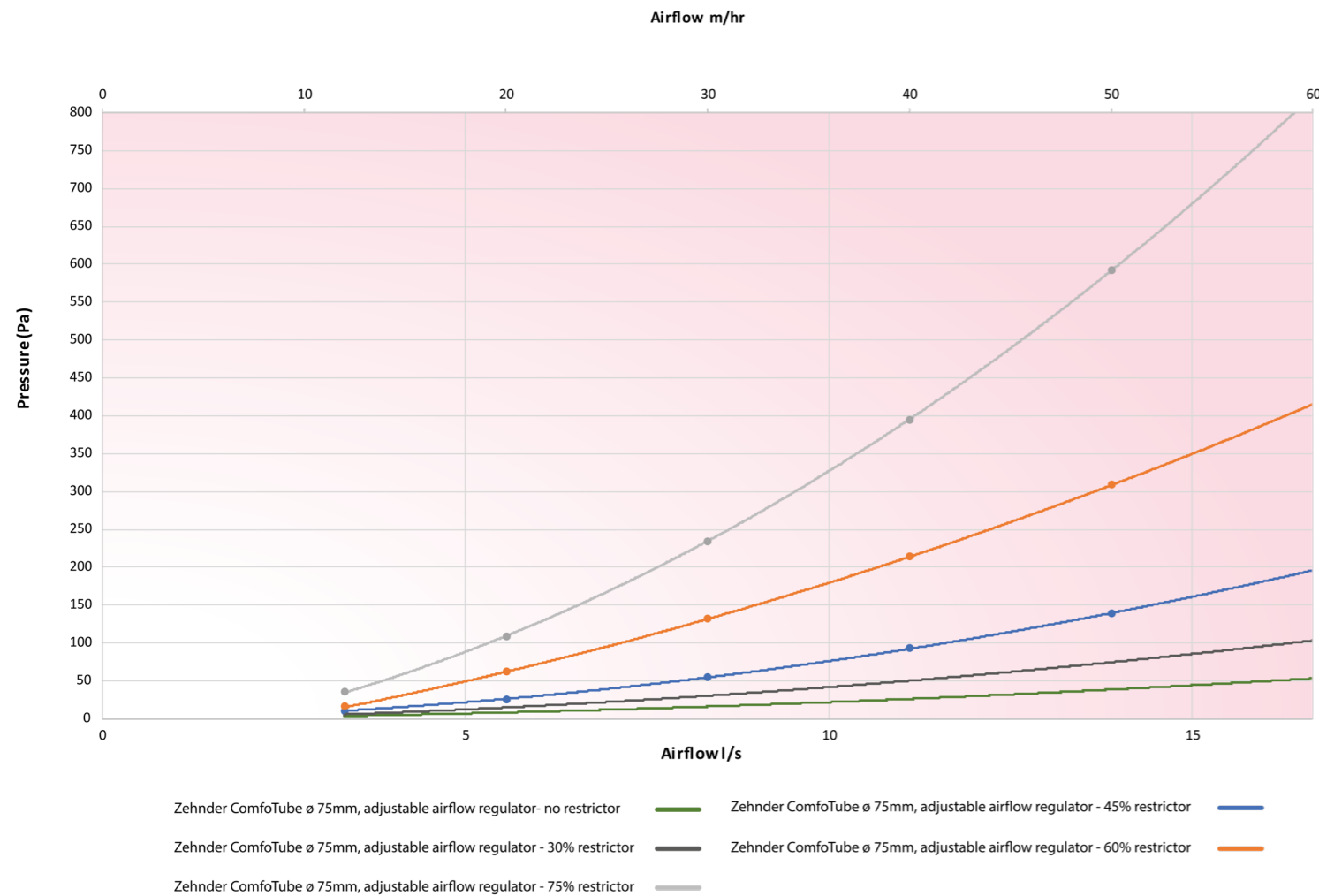

Filter for rectangular grille housing CSB-P 400, ISO Coarse >55% (G3), 10 Pieces

Article number: 990 321 768

Description

Grille housing filter:

Zehnder ComfoFresh filter for CSB-P grille housing. The filter is perfect to remove particles before they enter the ductwork and is quick and easy to install without interfering with the installed parts.

Technical Specification

Height	32mm
Width	342mm
Depth	55mm
Filter Grade	ISO Coarse <55% (G3)
Weight	<0.038 kg each
Material	Polyester

■ For use with ComfoGrid 400 slot diffusers



Filter for rectangular grille housing CSB-P 600, ISO Coarse >55% (G3), 10 Pieces

Article number: 990 321 769

Description

Grille housing filter:

Zehnder ComfoFresh filter for CSB-P grille housing. The filter is perfect to remove particles before they enter the ductwork and is quick and easy to install without interfering with the installed parts.

Technical Specification

Height	32mm
Width	542mm
Depth	55mm
Filter Grade	ISO Coarse <55% (G3)
Weight	<0.052kg each
Material	Polyester

■ For use with ComfoGrid 600 slot diffusers



Ancillaries - Zehnder ComfoFresh Flat 51 to Zehnder ComfoTube ø 75/90mm convertor

Article number: 990 322 013

Description

Zehnder ComfoFresh Flat 51 to Zehnder ComfoTube ø 75/90mm convertor:

Zehnder ComfoTube adjustable airflow regulator. The rigid connector can be used to convert Zehnder ComfoFresh Flat 51 to Zehnder ComfoTube ø 75 or Zehnder ComfoTube ø 90mm and comes complete with locking slides and O-rings.

Technical Specification

Height	97mm
Width	167mm
Depth	145mm
Weight	0.24kg
Material	High-density polyethylene (HDPE)



Dimensions

Front view

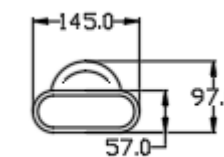

Top View

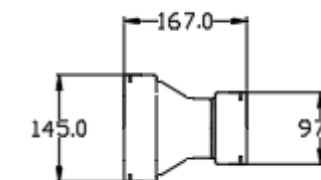

Pressure Curve

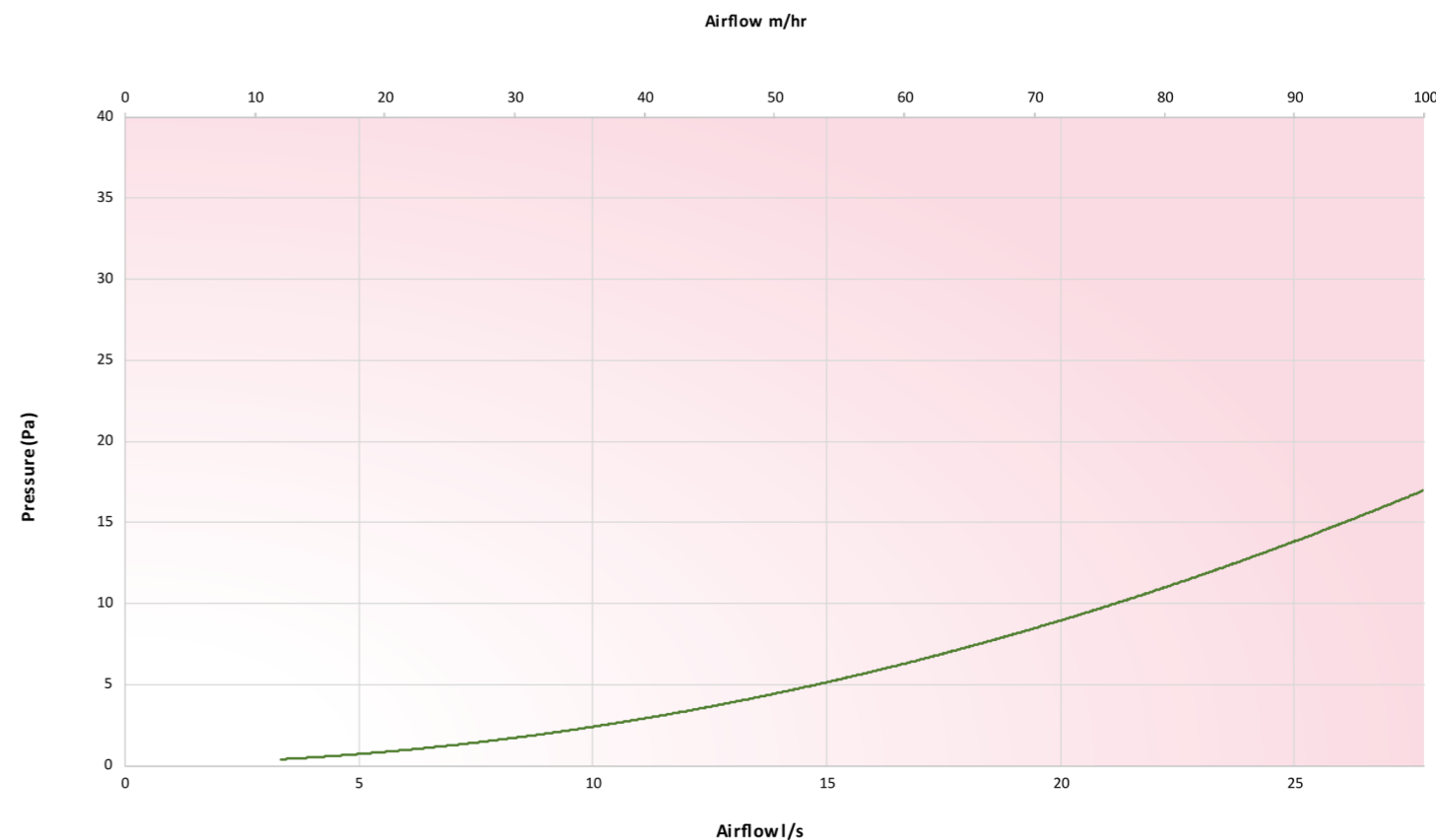

Ancillaries - Zehnder ComfoTube Flat 51 to 2 x Zehnder ComfoTube ø 75mm convertor

Article number: 990 322 150

Description

Zehnder ComfoTube Flat 51 to 2 x Zehnder ComfoTube ø 75mm convertor:

Zehnder ComfoTube Flat 51 to 2 x Zehnder ComfoTube ø 75mm convertor. The rigid connector can be used to convert Zehnder ComfoTube Flat 51 to 2 x Zehnder ComfoTube ø 75mm and comes complete with locking slides and O-rings.

Technical Specification

Height	81mm
Width	137mm
Depth	171mm
Weight	0.2kg
Material	High-density polyethylene (HDPE)



Dimensions

Side view



Front view

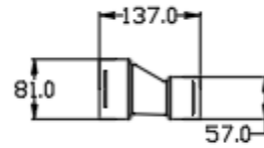

Top View

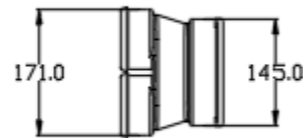

Ancillaries - Zehnder ComfoTube ø 75mm, 90° bend

Article number: 990 322 152

Description

Rigid 90° bend:

Zehnder ComfoTube ø 75mm, 90° bend. The rigid bend can be placed between two lengths of Zehnder ComfoTube ø 75mm or directly into the manifold / mounting plate and comes complete with locking slides.

Technical Specification

Height	173.8mm
Width	133.3mm
Depth	85.5mm
Weight	0.18kg
Material	High-density polyethylene (HDPE)



Dimensions

Side view

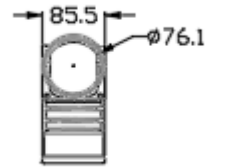

Front view

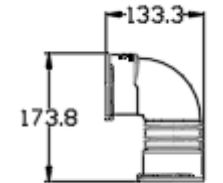

Top View



Pressure Curve

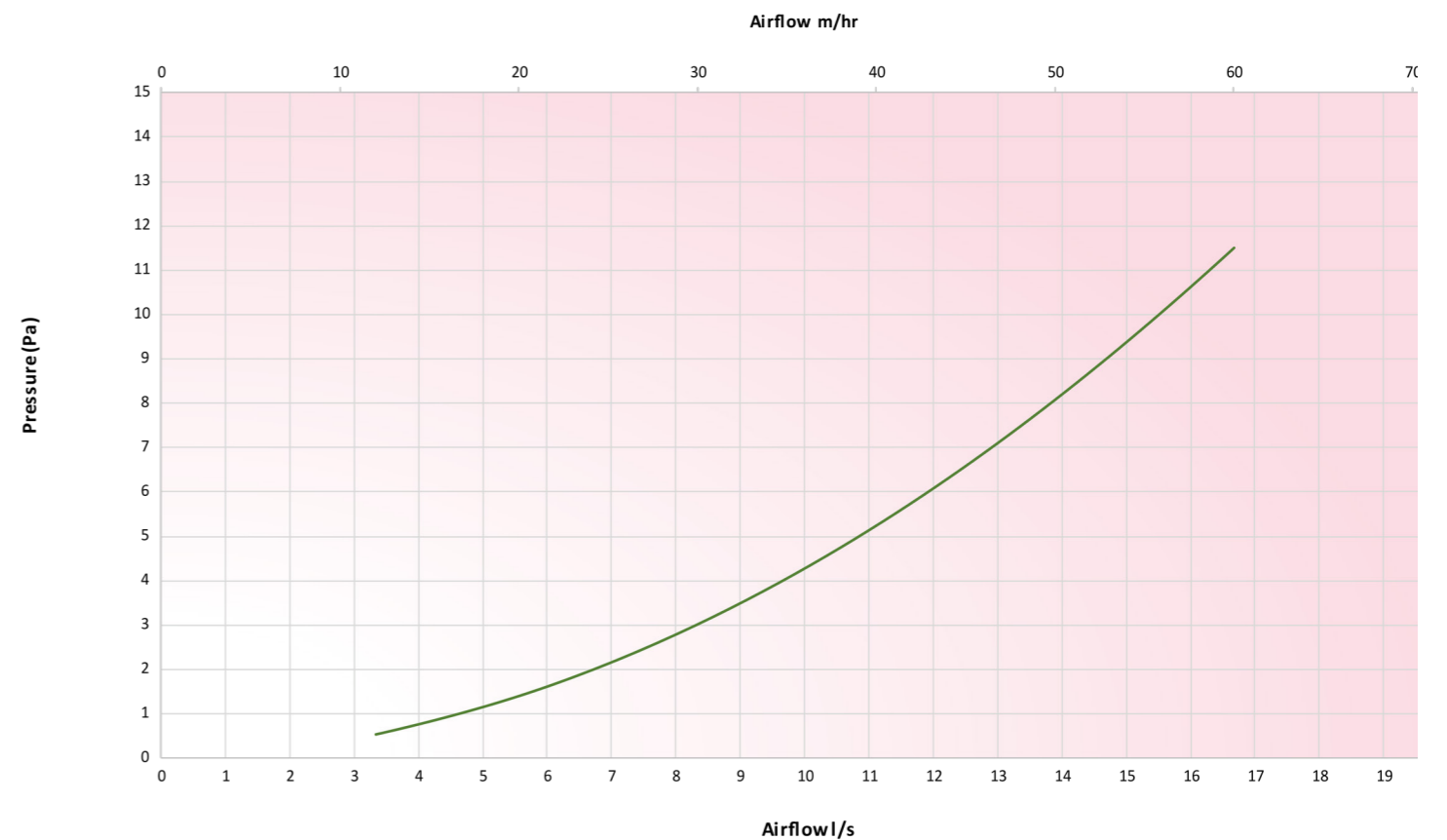

Zehnder ComfoTube ø 75mm, 90° bend

Ancillaries - Zehnder ComfoTube ø 75/90mm cross-piece

Article number: 990 322 155

Description

ComfoTube cross-piece:

Zehnder ComfoTube ø 75/90mm cross-piece. The compact cross-piece can be used to cross over two lengths of Zehnder ComfoTube ø 75mm or Zehnder ComfoTube ø 90mm in a height restricted space. The cross-piece comes complete with locking slides and O-rings.

Technical Specification

Height	105mm
Width	408mm
Depth	408mm
Weight	1.2 kg
Material	High-density polyethylene (HDPE)



Dimensions

Side view

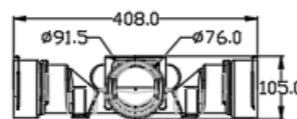

Front view

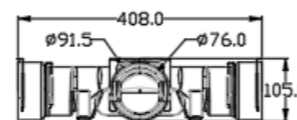

Top View

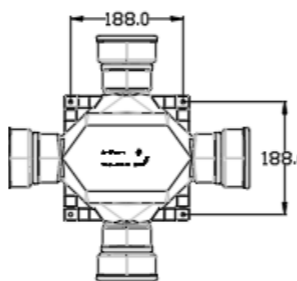

Pressure Curve

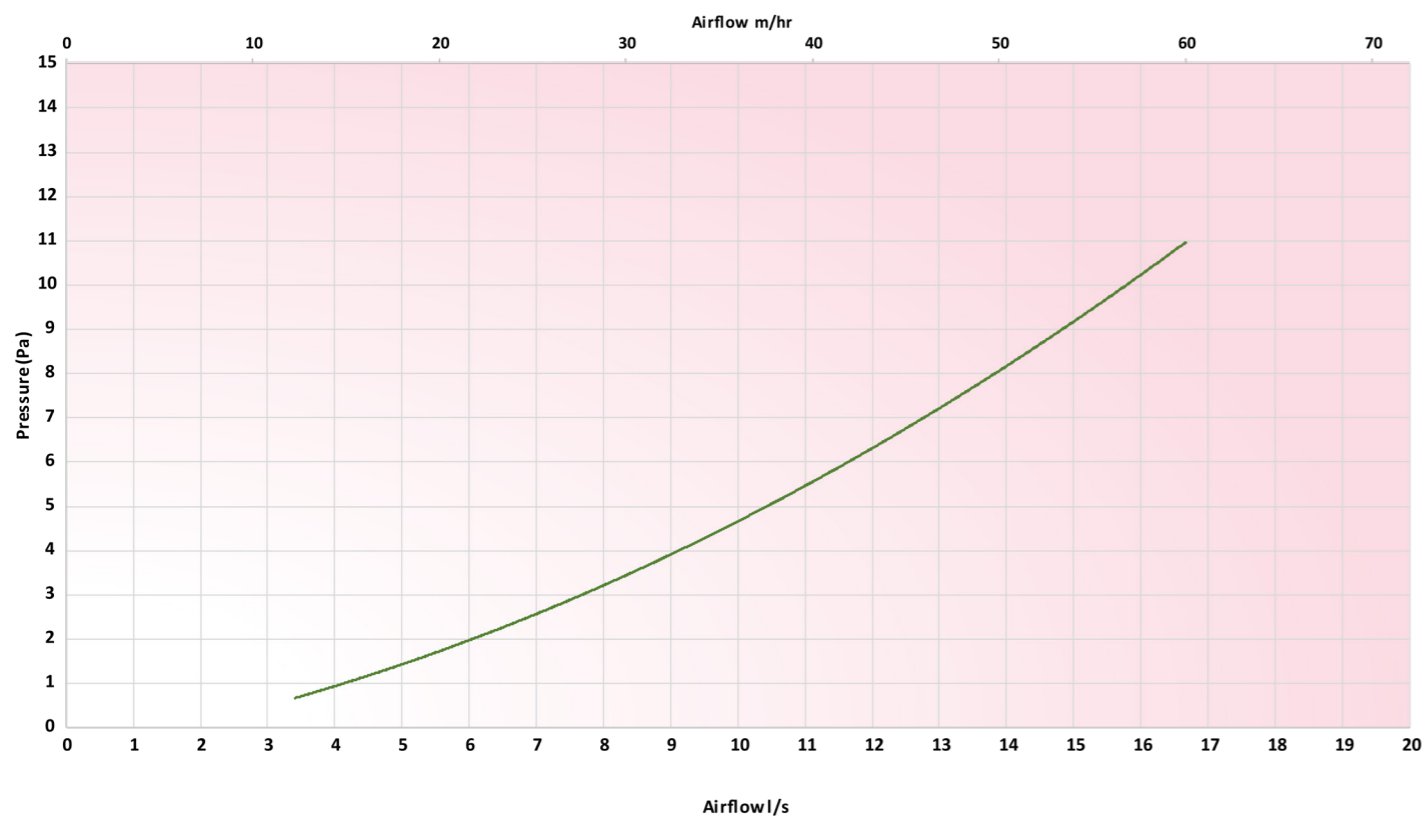

Zehnder ComfoTube ø 75/90mm cross-piece

Ancillaries - Zehnder ComfoTube ø 75mm, locking slides, 10 pieces

Article number: 990 326 024

Description

Locking slide:

Zehnder ComfoTube ø 75mm, locking slide. The locking slide is used to secure the Zehnder ComfoTube ø 75mm ductwork without the need for messy sealants.

Technical Specification

Weight	0.028kg (each)
Material	Galvanised steel

■ For use with Zehnder ComfoTube ø 75mm [ComfoWell](#) / Grille housings



Dimensions

Ancillaries - Grille housing TVA-P mounting set for concrete application

Article number: 990 326 127

Description

Mounting set:

Grille housing TVA-P 75/90 mounting set for concrete application. Used in conjunction with 64mm versions of the TVA-P to ensure quick installation to wooden framework prior to concrete being poured.

Technical Specification

Weight	0.08kg
Material	Polymer

■ For use with TVA-P L64mm versions



Ancillaries - 90° metal bracket for max 2 Zehnder ComfoTube

Article number: 990 327 109

Description

Metal bracket:

90° metal bracket for max 2 Zehnder ComfoTube. The mounting aid is to enable a 90 degree angle to be formed on Zehnder ComfoTube ø 75mm or Zehnder ComfoTube ø 90mm when attached to a horizontal surface.

Technical Specification

Height	200mm
Width	300mm
Depth	100mm
Weight	0.57kg
Material	Galvanised steel

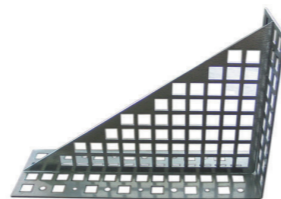

Ancillaries - Zehnder ComfoTube ø 75mm, pipe connector

Article number: 990 328 107

Description

Pipe connector:

Zehnder ComfoTube ø 75mm, pipe connector. The connector is used to join two lengths of Zehnder ComfoTube ø 75mm together to create an airtight and robust seal using O-rings.

Technical Specification

Height	164mm
Width	75.4mm
Depth	83.5mm
Weight	0.1kg
Material	Medium-density polyethylene



Dimensions

Side view

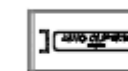

Front view

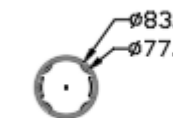

Top View

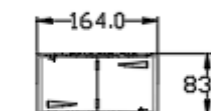

Ancillaries - Zehnder ComfoFix link for ComfoTube ø 75mm, 10 pieces

Article number: 990 327 200

Description

ComfoFix mounting bracket:

Zehnder ComfoFix link for ComfoTube ø 75mm. The mounting bracket can be prefixed on the floor/wall/ceiling and allows the Zehnder ComfoTube ø 75mm to be clicked in place.

Several brackets can also be linked on the horizontal or vertical level to fix Zehnder ComfoTube ø 75mm in place. Over 50% of time can be saved on installation using ComfoFix when compared to installation using perforated metal banding without the risk of damage to the ductwork.

Technical Specification

Height	90mm
Width	104.5mm
Depth	75mm
Weight	0.07 kg (each)
Material	Glass fiber reinforced polypropylene

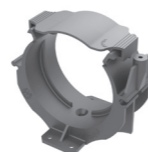

Dimensions

Side view

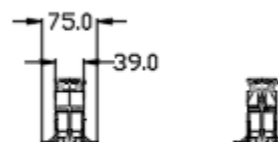

Front view

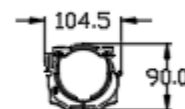

Top View

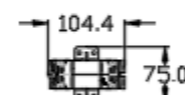

Ancillaries - Zehnder ComfoTube end caps, 10 pieces 75mm

Article number: 990 328 262

Description

End caps:

Zehnder ComfoTube end caps. The 75mm end caps can be placed within their corresponding Zehnder ComfoTube ø 75mm, during the construction phase to prevent dust ingress.

Technical Specification

Length	40.3mm
Diameter	67mm
Weight	0.016 kg
Material	Medium-density polyethylene



Ancillaries - Zehnder ComfoTube end caps, 10 pieces 90mm

Article number: 990 328 263

Description

End caps:

Zehnder ComfoTube end caps. The 90mm end caps can be placed within their corresponding Zehnder ComfoTube \varnothing 90mm during the construction phase to prevent dust ingress. The 90mm end caps can also be placed directly into the 75mm manifold or mounting plate to seal off any unwanted ports.



Technical Specification

Length	53.3mm
Diameter	82mm
Weight	0.031 (each)
Material	Medium-density polyethylene

Ancillaries - Zehnder ComfoTube \varnothing 75mm, O-ring seal, 10 pieces

Article number: 990 328 362

Description

O-ring:

Zehnder ComfoTube O-ring seal. The O-ring is used to ensure an airtight connection is made with pipe connectors, grille housings, manifold/mounting plates and connecting elements.



Technical Specification

Outside diameter	81mm
Inside diameter	61mm
Weight	0.006kg (each)
Material	EPDM (Ethylene Propylene Diene Monomer)

BIM/CAD Components

If you would like to download the BIM / CAD files for this or any other of our products then please visit our BIM library.

TO VISIT OUR BIM/CAD LIBRARY

CLICK HERE

Installation Instructions

If you would like to download the installation files for this or any other of our products then please visit our download page by clicking the link below.

TO VISIT OUR DOWNLOAD PAGE

CLICK HERE

Our Informational Videos



Watch our video on how to change the Zehnder ComfoFresh filter.

TO WATCH OUR VIDEO

CLICK HERE



Watch our video on how to clean the Zehnder ComfoFresh ductwork

TO WATCH OUR VIDEO

CLICK HERE

Consultant specification

Specification

The semi-rigid ductwork shall be dual wall constructed of high-quality food-grade plastic HDPE/LDPE with a crush resistant ring stiffness of $\sim 12.0 \text{ kN/m}^2$. It shall be suitable for installation into concrete with a fire rating in accordance with EN 13501 of E. It shall have an operating temperature range of -25 to $+40^\circ\text{C}$ and not be designed to exceed flowrates of 8.3l/s.

The ductwork shall be manufactured by Zehnder.