

# Start With ...

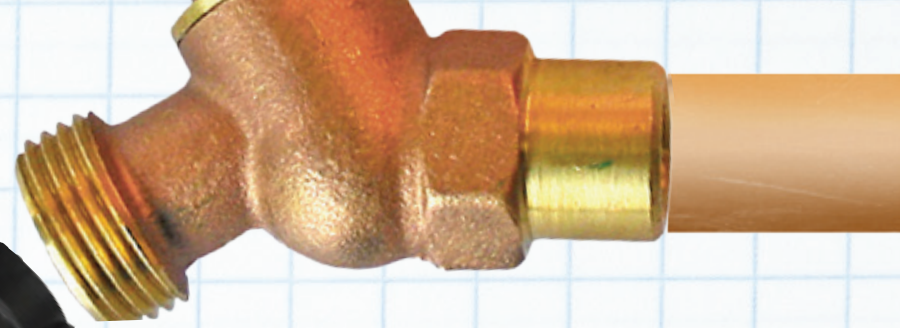

Attach "Y" connector to  
Hose Bib

Regular Flow Metal "Y"  
Connector with Shut-off  
FHT x MHT

IRH950

Vacuum Breaker  
(Anti-Siphon)

FHT x MHT

IRF1000

3/4" Brass Hose  
Swivel Adapter #1  
FHT x MPT

Use with Spin Clean Y  
Valve

Flushable "Y"  
Filter 3/4"  
FHT x MHT

IRF176

OR

Spin Clean Y  
Valve IRF178

3/4" Brass Adapter  
#2 MHT x FPT

Use with Spin Clean Y  
Valve

Calcium Filter,

Mr. Soaker Hose IRF900

Connects AFTER Flushable "Y" Filter

Mechanical or  
Electric  
Timer

Fixed Pressure Regulators

3/4" Med. Flow  
FHT x MHT

IRH819 10 PSI

IRH824 25 PSI

IRH830 50 PSI

Power-Loc™ Starter Tee  
FHT x MHT Up to 60 PSI

IRC700

1/2" Poly

1/2" Poly



# Poly Tubing

**3/4" Power-Loc™ Starter Fitting IRC730 FOR MALE HOSE THREAD**



OR

**3/4" Power-Loc™ Starter Fitting IRC745 FOR FEMALE HOSE THREAD**



**1/2" Power-Loc™ Starter Tee 50 PSI Pressure Regulator recommended IRC700**



OR

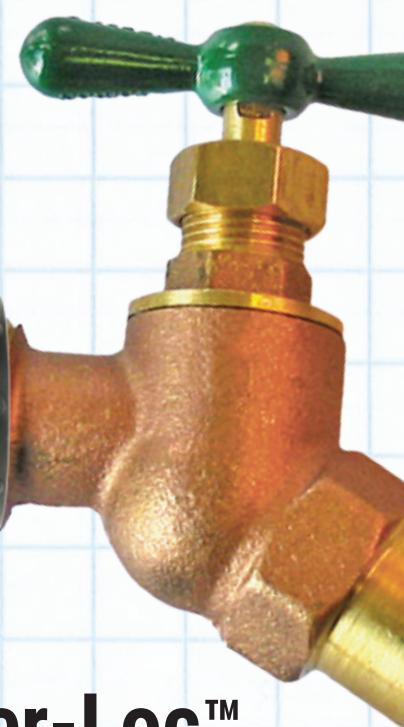

**1/2" Power-Loc™ Starter Elbow IRC705**



1/2" Poly

**1/2" Power-Loc™ Elbow IRC720**



1/2" Poly

**1/2" Power-Loc™ Tee IRC710**



1/2" Poly

1/2" Poly

1/2" Poly

**1/2" Power-Loc™ Inline Valve IRC735**



Insert into 1/2" poly tubing to open or shut off individual lines

OR

**1/2" Power-Loc™ Coupler IRC715**  
Great for repairing cracked or cut lines or extending lines



1/2" Poly

1/2" Poly

1/2" Poly

**In-line 1/2" Valve IRH430**





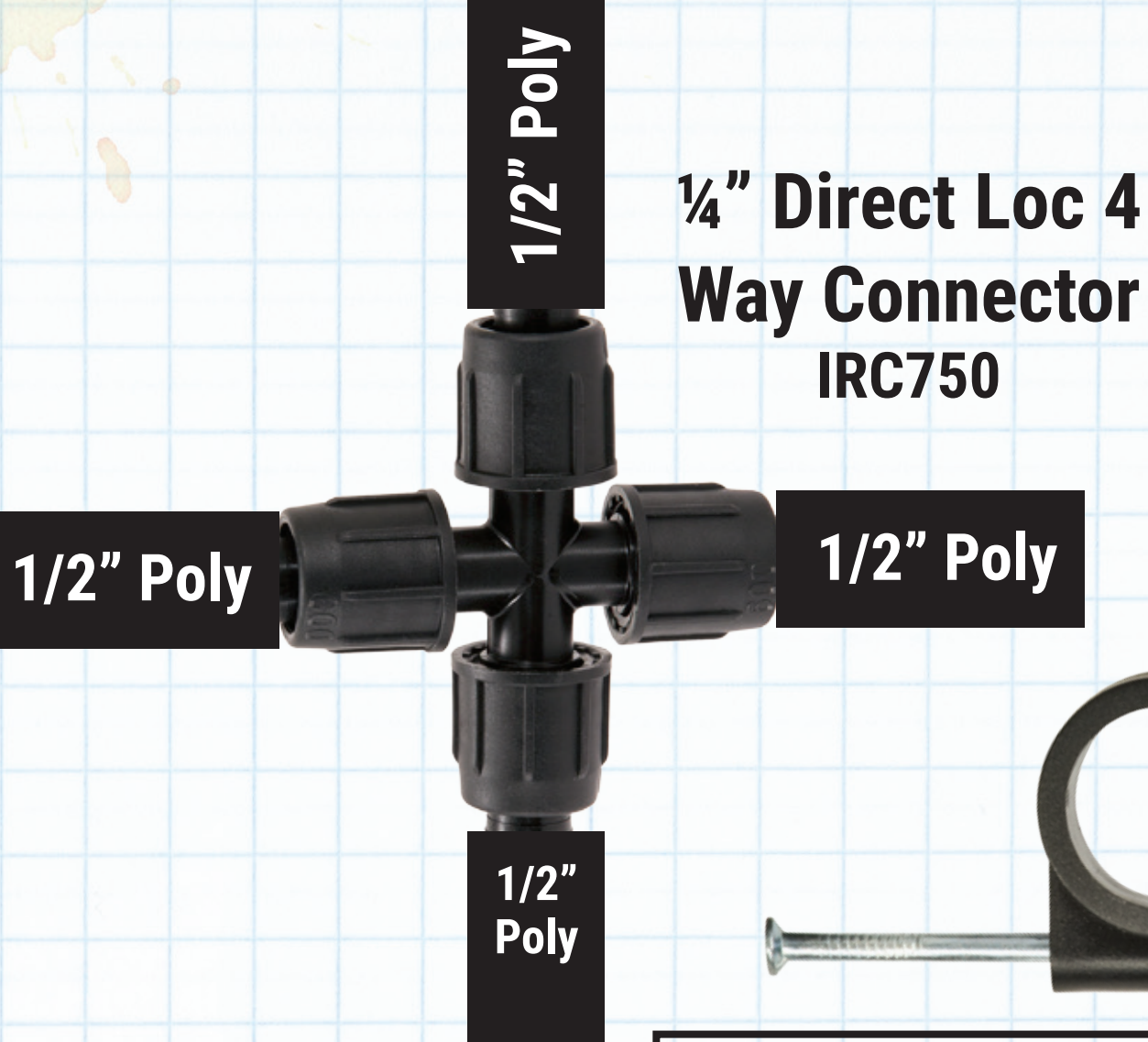

**1/2" Tubing Mounting Clip**  
IRP520

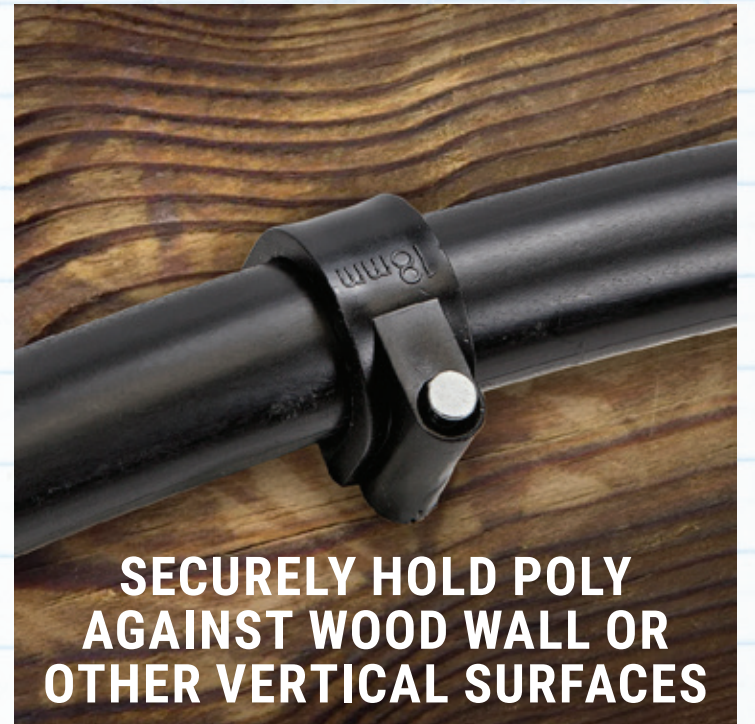

**CREATING HOLES**



**Pocket Punch Tool**  
For 1/2" poly tubing  
IRH640

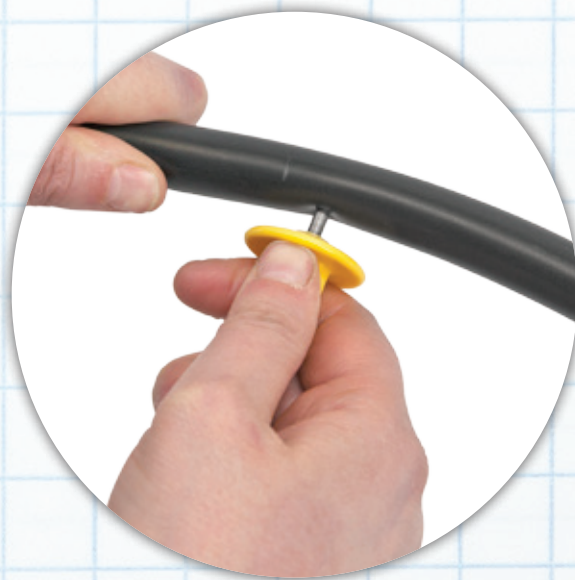

**Deluxe Yellow O-Jet Punch**  
For 1/2" poly tubing  
IRH630



**Hole Punch**  
For 1/4" Barbed Drip Tape Fittings  
IRC456

**END CAPS**

**1/2" Power-Loc™ End w/ Screw Cap**  
IRC725



**1/2" Figure 8 Closure** IRC545



**1/2" Power-Loc™ End w/ Flush Valve**  
IRC740

**1/2" Poly**

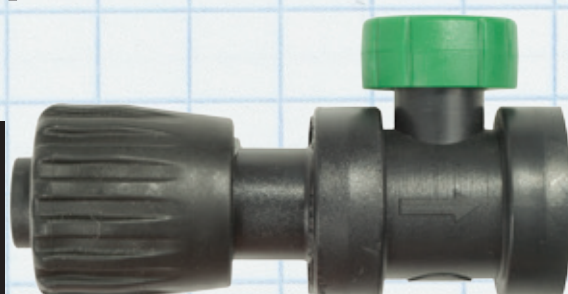



# Drip Tape

Can only be used in STRAIGHT lines

**Tape-Loc™ 1/2" Barbed  
IRC470**

**Poly Tubing**

**Drip Tape**

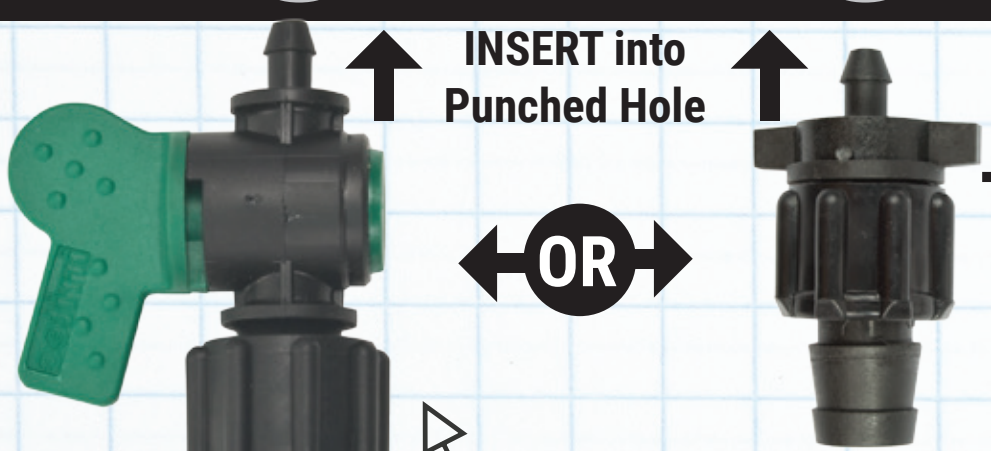

INSERT into  
Punched Hole

OR

**Tape-Loc™-Sleeve 1/4"  
Barbed IRC450**

**Perma-Loc-Sleeve 1/4"  
Barbed Fitting w/Shutoff**

Allows you to shut off individual  
drip tape lines  
**IRC454**

Space each run 8" apart  
to stagger emitters for  
complete coverage for  
most soil types



**Drip Tape**

**Drip Tape**

**Drip Tape**

**Drip Tape**

**Drip Tape**

**Tape-Loc™ Tee  
IRC420**

**Tape-Loc™ Coupler  
IRC410**

*Great for  
repairing damaged  
Drip Tape*

**Fixed Pressure Regulator  
IRH819**

**10 PSI is Strongly Recommended  
or Drip tape May Burst**

**Tape-Loc™ Elbow  
IRC415**

**Drip Tape**

**Tape-Loc™ Hose Starter IRC425**



# ENDING DRIP TAPE



**Drip Tape Sleeve End  
IRC441**

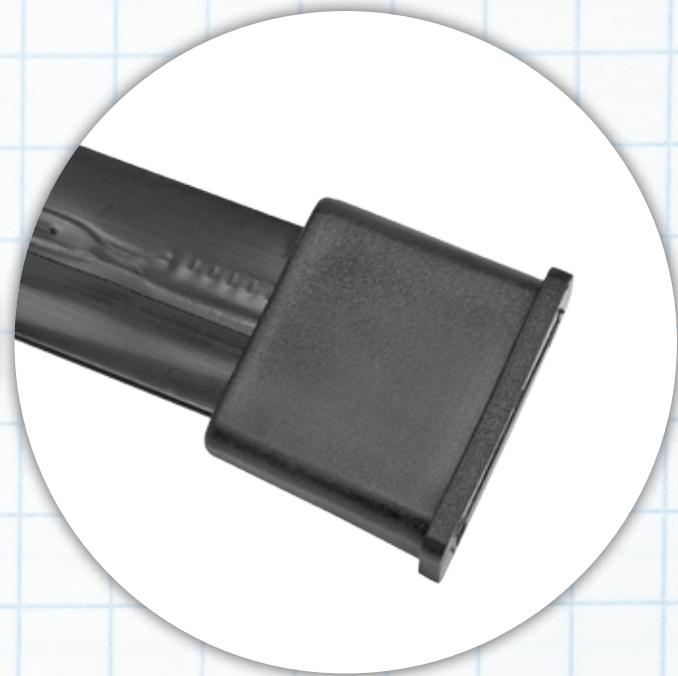
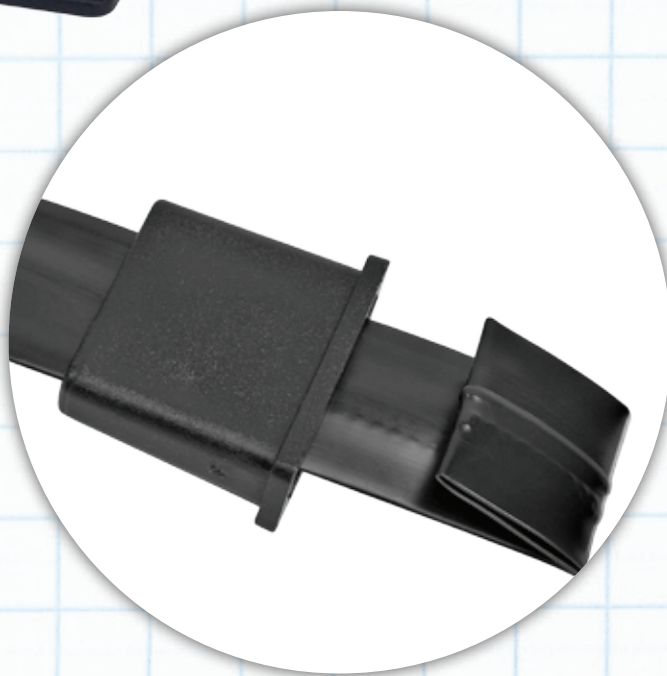
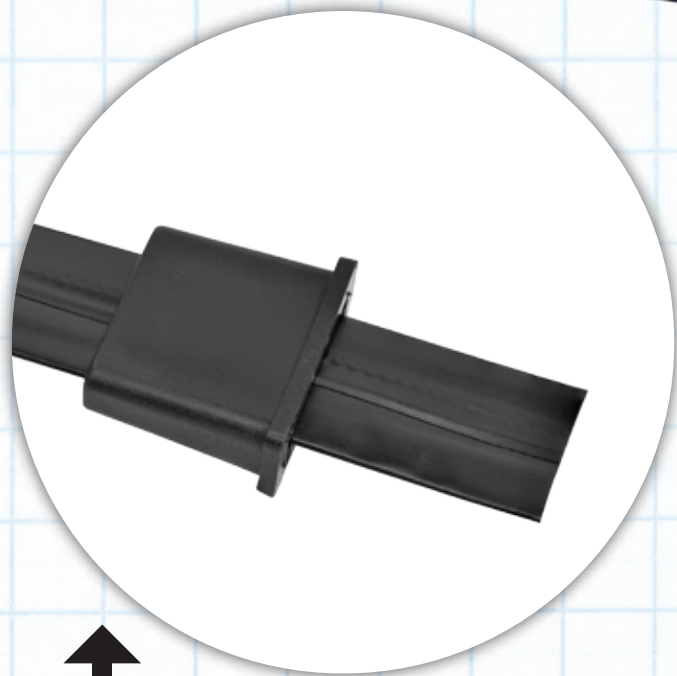

OR

**Fold Drip Tape and push Sleeve End over folds**

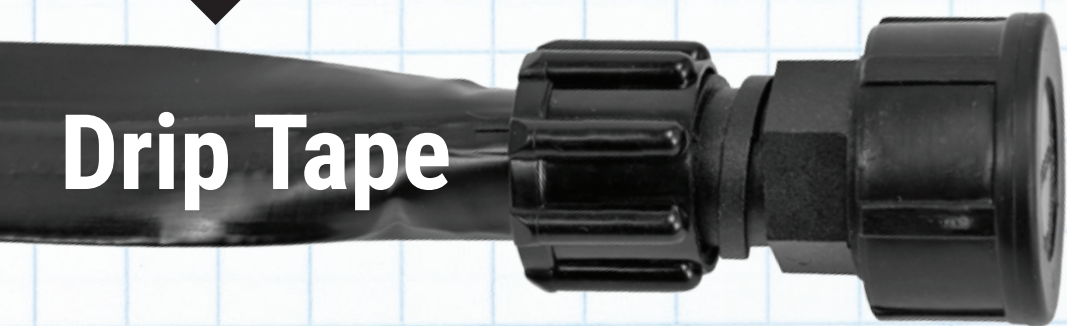

**Drip Tape**

**Tape-Loc™ End with Cap  
IRC440**

# Emitterline

**Emitterline can be used like Drip Tape. The difference is Emitterline can curve (especially true for 1/4" emitterline) and has pressure compensating emitters installed internally to allow use on slopes. USE POLY TUBING FITTINGS FOR 1/2" EMITTERLINE**

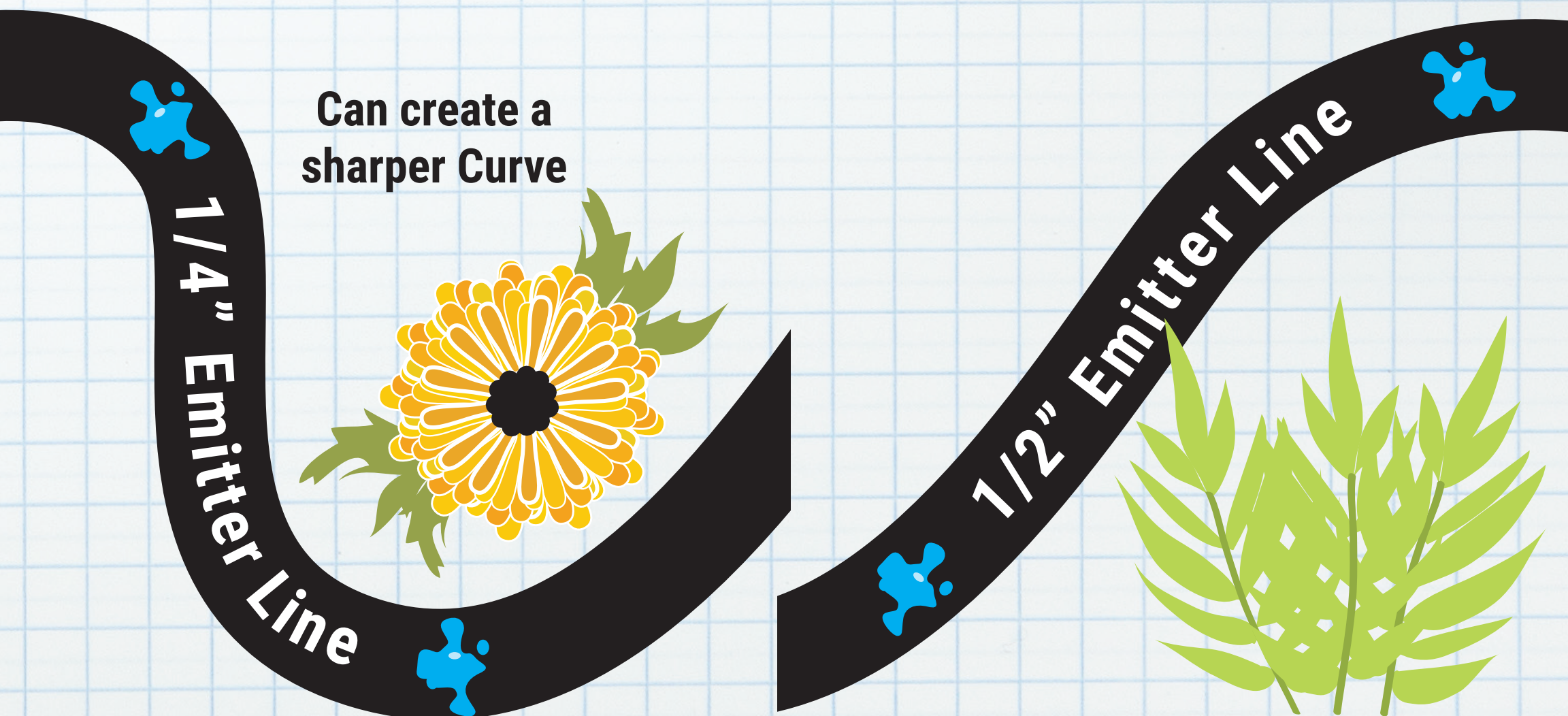

**Can create a sharper Curve**

**1/4" Emitter Line**

**1/2" Emitter Line**



# Soaker Hose

1/2" Barbed  
Hose Starter  
IRC625

Soaker  
Hose

Metal Hose  
Clamp IRC607

Fixed Pressure Regulators (Strongly  
recommended) IRH824 20-25 PSI

1/2" Barbed Elbow  
IRC615

Soaker  
Hose

1/2" Barbed  
End cap  
IRC641

Soaker  
Hose

1/2" Poly

1/2" Barbed Tee  
IRF900

1/2" Poly

Soaker  
Hose

1/2" Barbed Coupler  
IRC610

Calcium Filter, Mr.  
Soaker Hose IRF900

Strongly recommended if you  
have hard water to prevent the  
clogging of your soaker hose

Soaker  
Hose

Mr.  
Soaker Hose

Calcium Inhibitor Filter



# Mini Sprinkler Assembly



**12" Riser Tube**  
IRR642

*Holds Riser tube*



**OLSON 0-JET SPRAYERS**

**18" Riser Tube**  
IRR648



**OLSON MINI-SPRINKLER**

**6" Riser**  
IRR615

**5" Spike Stake w/Barb**  
IRR611

**12" Irrigation Stake**  
IRR609

**1/4" Threaded Barbs** IRR650  
*Attaches riser tube to 1/4" poly tubing*

**Olson Clamp For 3/8"**  
IRR628

**Olson Stabilizer Base**  
IRR620



**CETA Pressure-Compensating Emitters**

**OR**

**Flag Emitters**

**Vari-Flow™ 1/4" In-Line Valve**  
IRH415

**Short Stake**  
IRR605



# Mini Sprinklers

## Micro-Sprayers With Flow Control



IRS700

360°

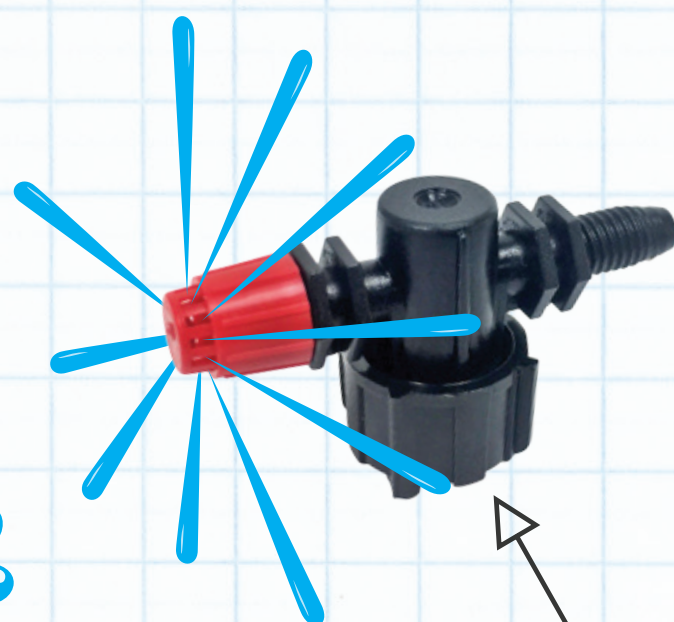

Flow Control



IRS705

180°



Nozzle Swivels  
for Directional  
Control

Flow Control

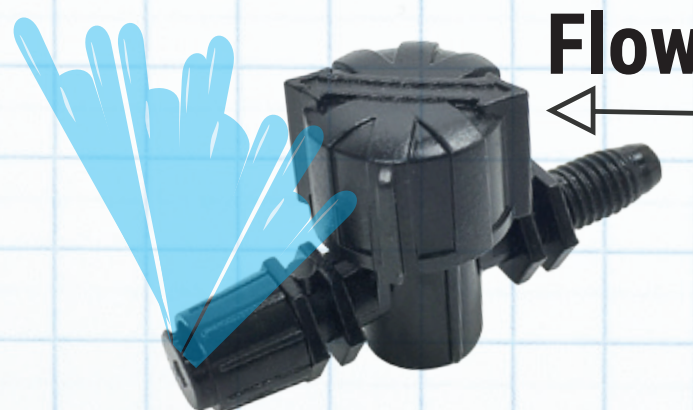

Flow Control

IRS710

90°



Nozzle Swivels  
for Directional  
Control

## Olson Ultra-Jet Sprayers

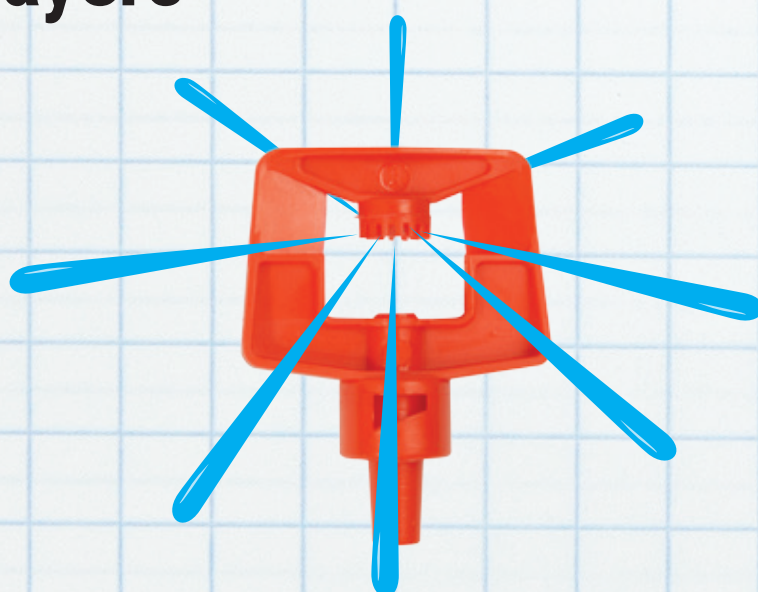

IRS692, IRS686, IRS680

360°

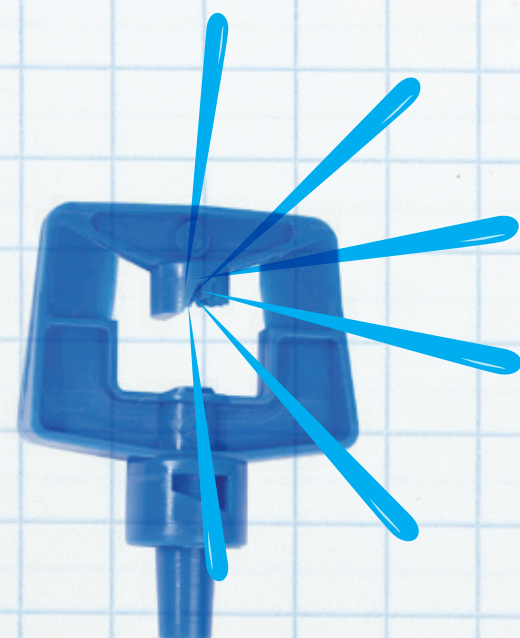

IRS694, IRS688, IRS682

180°





## Olson Mini-Sprinklers

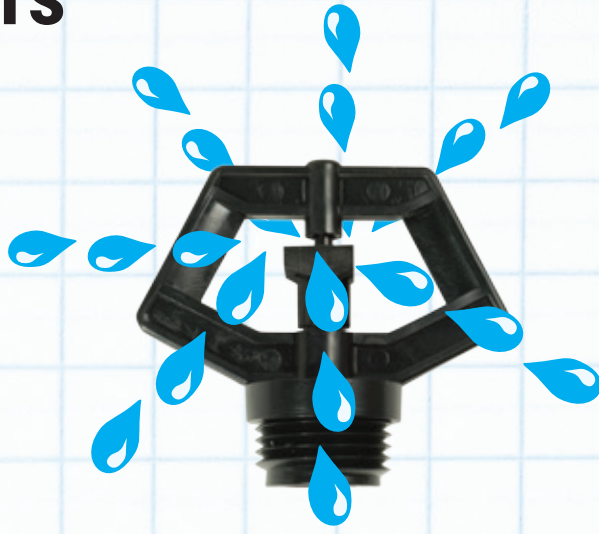

**IRS620**  
Spray Dia. 11'-17'

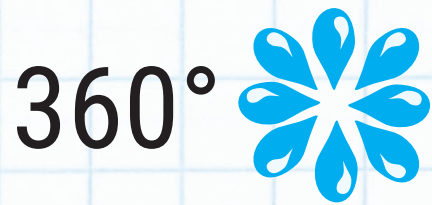

**IRS619**  
Spray Dia. 19'-26'

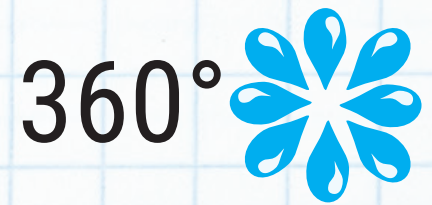

## Olson O-Jet Sprayers

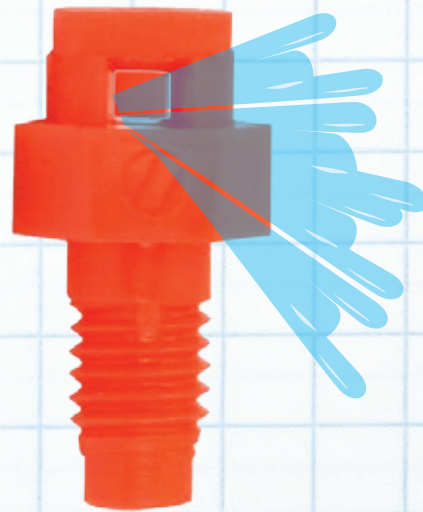

**IRS664, IRS654,  
IRS644**

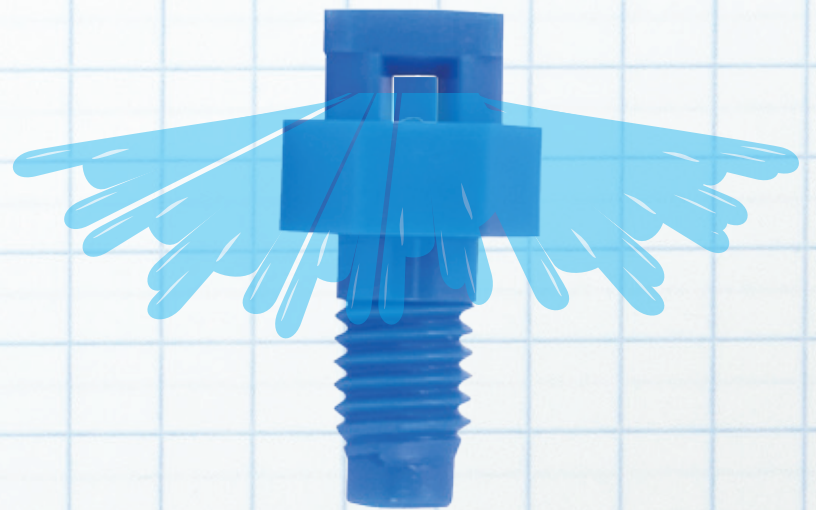

**IRS662, IRS652,  
IRS642**

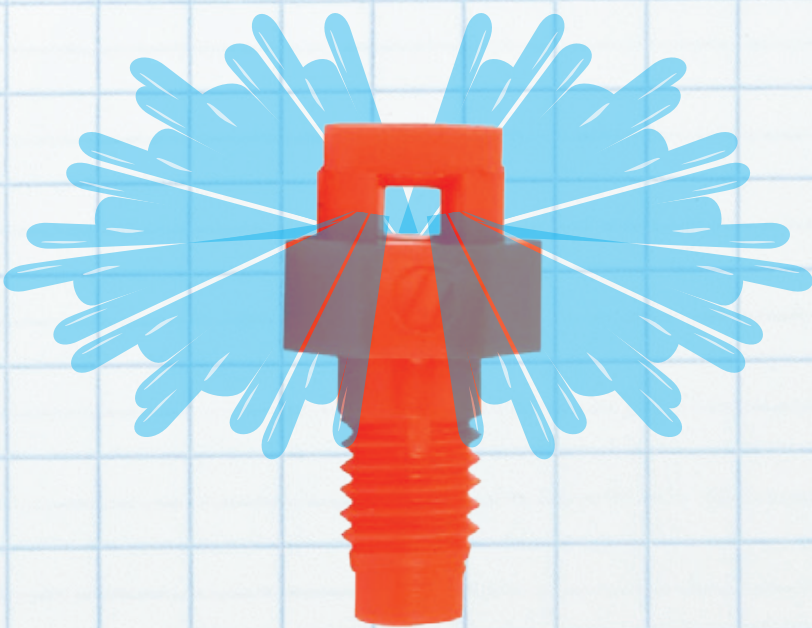

**IRS660, IRS650,  
IRS640**

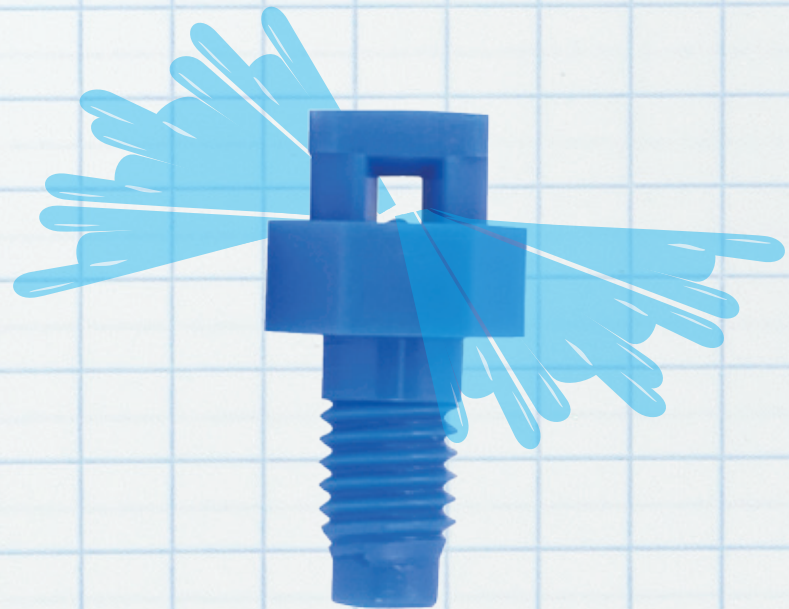

**IRS669, IRS659,  
IRS649**

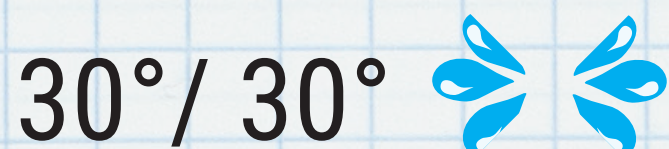



# Sprayers



**Spectrum Spray  
360 on Stake  
IRS805**

OR

**Spectrum Spray  
360  
IRS800**

**1/4"  
Barbed  
Coupler  
IRC210**



INSERT into  
Punched Hole



1/2" Poly

**Shrubber® On  
A Stake  
IRE205**

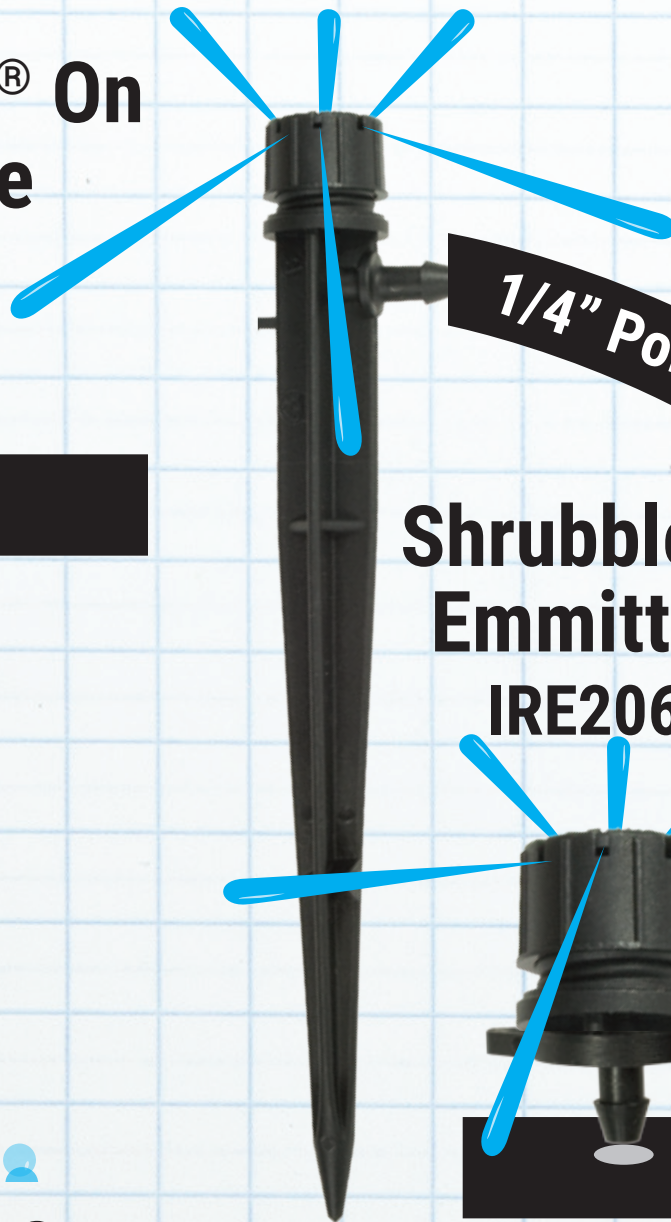

1/4" Poly

Use Ground  
Staples to  
secure Poly to  
ground

1/2" Poly



INSERT into  
Punched Hole

**Fogger-Mister  
IRE200**

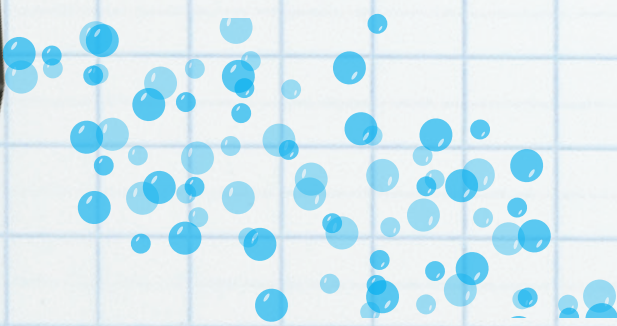

**Shrubber®  
Emitter  
IRE206**

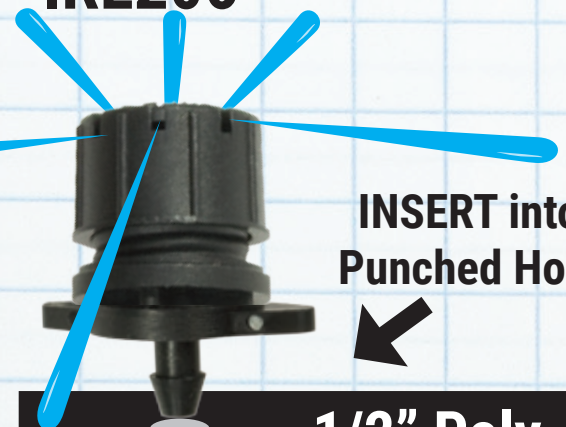

INSERT into  
Punched Hole

1/2" Poly

1/8" Poly

Cap off with  
1/8" poly to  
prevent any  
water flow



**Aquatic Tri-Tip Sprayers  
IRE250 Three Flow Rates in one!**

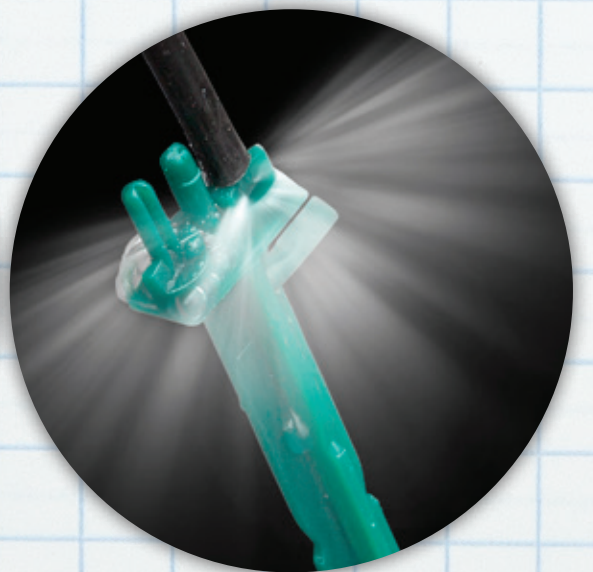
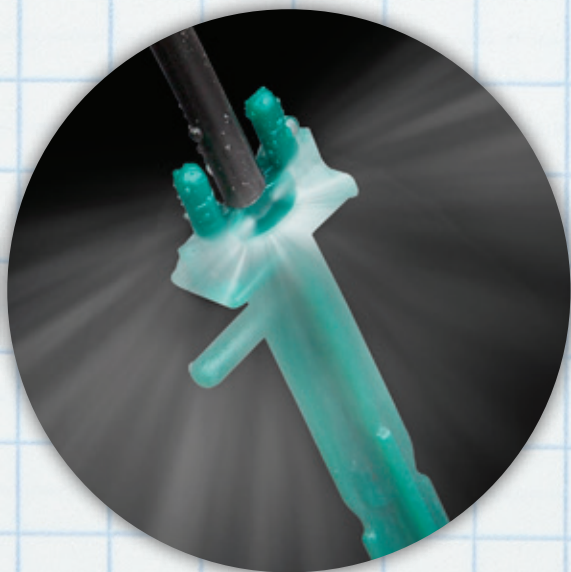



# Drip Emitters

1/2" Poly



Short Stake IRR605

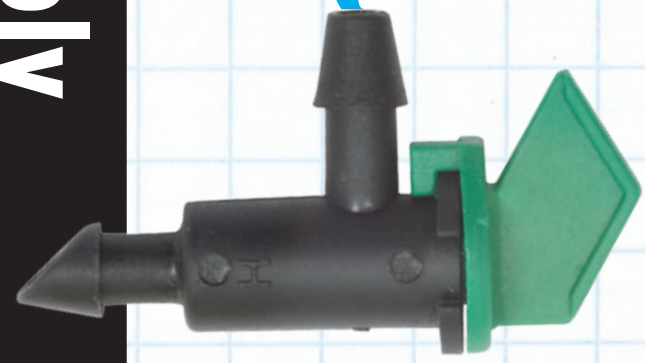

Flag Emitters



Mini-Flo Inline Emitters

1/4" Elbow IRC215

1/4" Poly

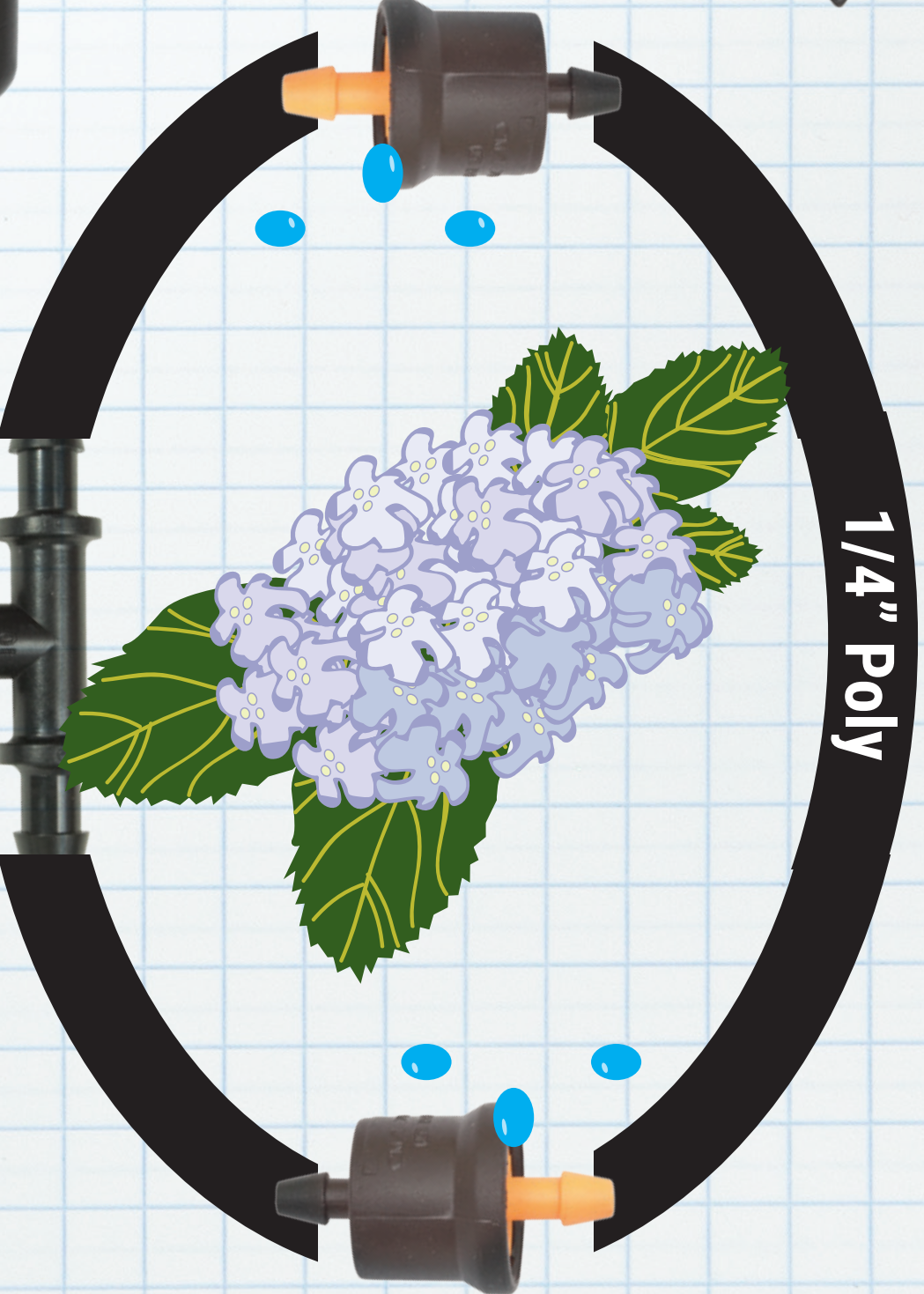

Goof Plug IRH634

Use to Fix Holes in 1/2" Poly or Plug end of 1/4" Poly



1/4" Poly



1/4" Barbed Coupler IRC210

1/4" Tee IRC220

OR



1/4" Barbed Coupler Heavy Duty IRC211