

# NEWS 2020-2021 PRODUCT CATALOGUE



**RED LIGHT**

[red-lightfrance.com](http://red-lightfrance.com)

*Focus on the value of light*



**REDLIGHT**  
FOR HOUSE

*Focus on the value of light*





**Scenario**  
Exhibition tubes, hallways

## LED TRACK LIGHT SERIES

Simple and elegant designed led track light with high quality aluminum body, with multiple reflecting angles, specially designed heatsink with excellent dissipation to minimize degradation of the lumens.

Application: fashion stores, chain store, shopping mall, showrooms, art galleries.



90 degree Adjust up and down



355 degree Adjust Horizontal rotation



Glare cut angle of 20 degree





### RD4050

Simple and elegant designed led track light with high quality aluminum body, with multiple reflecting angles, specially designed heatsink with excellent dissipation to minimize degradation of the lumens.

Application: fashion stores, chain store, shopping mall, showrooms, art galleries.



### RD4045

STRUCTURE CHARACTERISTICS

Selected reflector

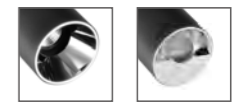

+  
Symmetric optics



General Lighting



+  
Asymmetric optics



Wall washer



Reflector color option



# RD4050 SERIES

Color selection  
B S W



## RD4050-35

Max. 36W

Operating Temp.: -30°C + 40°C

32W COB chip (DC850mA)

- 2700K/2450lm CRI90
- 3000K/2730lm CRI90
- 4000K/3100lm CRI90
- 5000K/3400lm CRI80

Internal Driver: AC100-240V 50/60Hz

Driver performance: Non-dimmable/dimmable

Dimmer: 0~10v/Triac/Dali

Beam angle

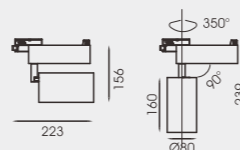
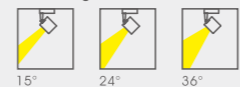

# RD4050 SERIES

Color selection  
B S W



## RD4050-15

Max. 15W

Operating Temp.: -30°C + 40°C

13.5W COB chip (DC350mA)

- 2700K/1050lm CRI90
- 3000K/1200lm CRI90
- 4000K/1390lm CRI90
- 5000K/1580lm CRI80

Internal Driver: AC100-240V 50/60Hz

Driver performance: Non-dimmable/dimmable

Dimmer: 0~10v/Triac/Dali

Beam angle

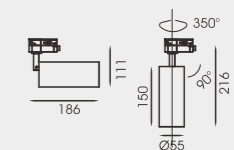

## RD4050-30

Max. 30W

Operating Temp.: -30°C + 40°C

26W COB chip (DC600mA)

- 2700K/2107lm CRI90
- 3000K/2340lm CRI90
- 4000K/2645lm CRI90
- 5000K/2943lm CRI80

Internal Driver: AC100-240V 50/60Hz

Driver performance: Non-dimmable/dimmable

Dimmer: 0~10v/Triac/Dali

Beam angle

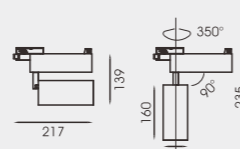
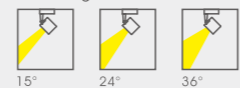

## RD4050-07

Max. 7W

Operating Temp.: -30°C + 40°C

5W COB chip (DC150mA)

- 2700K/420lm CRI90
- 3000K/470lm CRI90
- 4000K/540lm CRI80
- 5000K/605lm CRI80

Internal Driver: AC100-240V 50/60Hz

Driver performance: Non-dimmable/dimmable

Dimmer: 0~10v/Triac/Dali

Beam angle

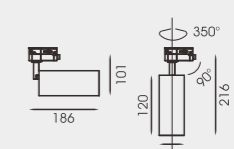

# RD4045 SERIES

Color selection  
B S W



## RD4045-35

Max. 35W

Operating Temp. : -30°C + 40°C  
32W COB chip (DC850mA)  

- 2700K/2450lm CRI90
- 3000K/2730lm CRI90
- 4000K/3080lm CRI90
- 5000K/3360lm CRI80

Internal Driver: AC100-240V 50/60Hz  
Driver performance: Non-dimmable/dimmable  
Dimmer: 0~10v/Triac/Dali

Beam angle

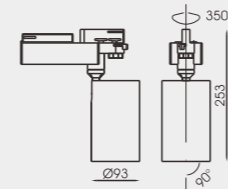

Reflector color option



# RD4045 SERIES

Color selection  
B S W



## RD4045-10

Max. 10W

Operating Temp. : -30°C + 40°C  
10W COB chip (DC250mA)  

- 2700K/700lm CRI90
- 3000K/800lm CRI90
- 4000K/930lm CRI90
- 5000K/1020lm CRI80

Internal Driver: AC100-240V 50/60Hz  
Driver performance: Non-dimmable/dimmable  
Dimmer: 0~10v/Triac/Dali

Beam angle

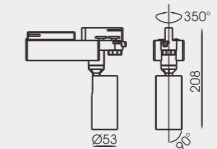

Reflector color option



## RD4045-24

Max. 24W

Operating Temp. : -30°C + 40°C  
24W COB chip (DC600mA)  

- 2700K/1750lm CRI90
- 3000K/1950lm CRI90
- 4000K/2200lm CRI90
- 5000K/2340lm CRI80

Internal Driver: AC100-240V 50/60Hz  
Driver performance: Non-dimmable/dimmable  
Dimmer: 0~10v/Triac/Dali

Beam angle

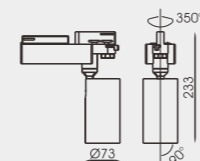

Reflector color option





Color selection  
B S W

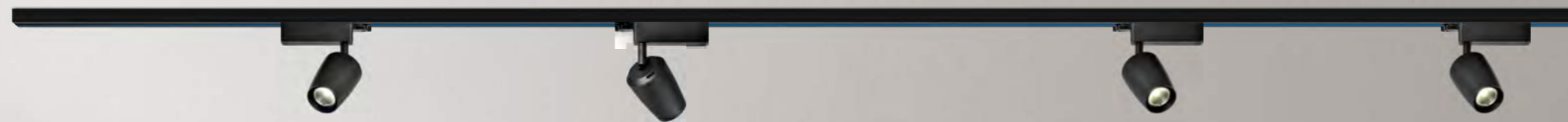

### RD4046-40

Max.40W

Operating Temp. : -30°C + 40°C  
40W COB chip (DC1000mA)

- 2700K/3000lm CRI90
- 3000K/3200lm CRI90
- 4000K/3280lm CRI90
- 5000K/3400lm CRI80

Internal Driver: AC100-240V 50/60Hz  
Driver performance: Non-dimmable/dimmable  
Dimmer: 0-10v/Triac/Dali

Beam angle

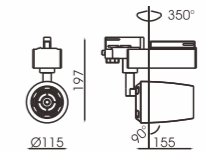
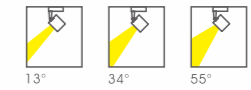

### RD4046-20

Max.20W

Operating Temp. : -30°C + 40°C  
20W COB chip (DC500mA)

- 2700K/1500lm CRI90
- 3000K/1600lm CRI90
- 4000K/1640lm CRI90
- 5000K/1700lm CRI80

Internal Driver: AC100-240V 50/60Hz  
Driver performance: Non-dimmable/dimmable  
Dimmer: 0-10v/Triac/Dali

Beam angle

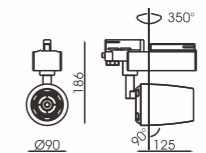
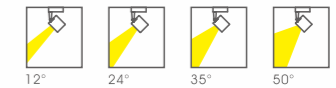









# RD4049 SERIES

Color selection  
B S W



## RD4049-30

Max. 30W

Operating Temp. : -30°C + 40°C  
SMD2835PCS(DC700mA)

- 2700K/1125lm CRI90
- 3000K/1200lm CRI90
- 4000K/1350lm CRI90
- 5000K/1500lm CRI80

Internal Driver: AC100-240V 50/60Hz  
Driver performance: Non-dimmable/dimmable  
Dimmer: 0~10v/Triac/Dali

Beam angle



80°

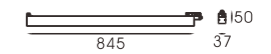

## RD4049-15

Max. 15W

Operating Temp. : -30°C + 40°C  
SMD2835\* 84PCS(DC350mA)

- 2700K/1125lm CRI90
- 3000K/1200lm CRI90
- 4000K/1350lm CRI90
- 5000K/1500lm CRI80

Internal Driver: AC100-240V 50/60Hz  
Driver performance: Non-dimmable/dimmable  
Dimmer: 0~10v/Triac/Dali

Beam angle



80°







## LED SURFACE/ SUSPENSION LAMP SERIES

Simple and elegant designed LED pendant Light with high quality aluminum body, specially designed heatsink for good dissipation to minimize degradation of the lumens.

Application: household decorative lighting, shops, hotels bars, coffee shops.



# RD4050A SERIES

Color selection  
B S W



## RD4050A-35

Max. 35W

Operating Temp. : -30°C + 40°C

32W COB chip (DC850mA)

- 2700K/2450lm CRI90
- 3000K/2730lm CRI90
- 4000K/3100lm CRI90
- 5000K/3400lm CRI80

Internal Driver: AC100-240V 50/60Hz

Driver performance: Non-dimmable/dimmable

Dimmer: 0~10v/Triac/Dali

Symmetrical



18° 24° 36°



# RD4050A SERIES

Color selection  
B S W



## RD4050A-15

Max. 15W

Operating Temp. : -30°C + 40°C

13.5W COB chip (DC350mA)

- 2700K/1050lm CRI90
- 3000K/1200lm CRI90
- 4000K/1390lm CRI90
- 5000K/1580lm CRI80

Internal Driver: AC100-240V 50/60Hz

Driver performance: Non-dimmable/dimmable

Dimmer: 0~10v/Triac/Dali

Symmetrical



15° 24° 36°



## RD4050A-30

Max. 30W

Operating Temp. : -30°C + 40°C

26W COB chip (DC600mA)

- 2700K/2107lm CRI90
- 3000K/2340lm CRI90
- 4000K/2645lm CRI90
- 5000K/2943lm CRI80

Internal Driver: AC100-240V 50/60Hz

Driver performance: Non-dimmable/dimmable

Dimmer: 0~10v/Triac/Dali

Symmetrical



15° 24° 36°



## RD4050A-07

Max. 7W

Operating Temp. : -30°C + 40°C

5W COB chip (DC150mA)

- 2700K/420lm CRI90
- 3000K/470lm CRI90
- 4000K/540lm CRI90
- 5000K/605lm CRI80

Internal Driver: AC100-240V 50/60Hz

Driver performance: Non-dimmable/dimmable

Dimmer: 0~10v/Triac/Dali

Symmetrical



15° 24° 36°





# RD3040 SERIES

Color selection  
B S W



Selected reflector



Symmetrical Asymmetric optics

## RD3040-35

Max. 35W

Operating Temp.: -30°C + 40°C

32W COB chip (DC850mA)

- 2700K/2450lm CRI90
- 3000K/2730lm CRI90
- 4000K/3080lm CRI90
- 5000K/3360lm CRI80

Internal Driver: AC100-240V 50/60Hz

Driver performance: Non-dimmable/dimmable

Dimmer: 0~10v/Triac/Dali

Symmetrical



18° 23° 36°

Asymmetric optics



wallwasher



Ø93



165



Ø93



165

# RD3040 SERIES

Color selection  
B S W



Selected reflector



## RD3040-10

Max. 10W

Operating Temp.: -30°C + 40°C

10W COB chip (DC250mA)

- 2700K/700lm CRI90
- 3000K/800lm CRI90
- 4000K/930lm CRI90
- 5000K/1020lm CRI80

Internal Driver: AC100-240V 50/60Hz

Driver performance: Non-dimmable/dimmable

Dimmer: 0~10v/Triac/Dali

Symmetrical



15° 23° 35°

Asymmetric optics



wallwasher



Ø53



110



Ø53



110



Selected reflector



Symmetrical Asymmetric optics

## RD3040-24

Max. 24W

Operating Temp.: -30°C + 40°C

24W COB chip (DC600mA)

- 2700K/1750lm CRI90
- 3000K/1950lm CRI90
- 4000K/2200lm CRI90
- 5000K/2340lm CRI80

Internal Driver: AC100-240V 50/60Hz

Driver performance: Non-dimmable/dimmable

Dimmer: 0~10v/Triac/Dali

Symmetrical



15° 23° 35°

Asymmetric optics



wallwasher



Ø73



145



Ø73



145

# RD3040A SERIES

Color selection  
B S W



Reflector color option



## RD3040A-35

Max. 35W

Operating Temp. : -30°C + 40°C

32W COB chip (DC850mA)

- 2700K/2450lm CRI90
- 3000K/2730lm CRI90
- 4000K/3080lm CRI90
- 5000K/3360lm CRI80

Internal Driver: AC100-240V 50/60Hz

Driver performance: Non-dimmable/dimmable

Dimmer: 0~10v/Triac/Dali

Beam angle

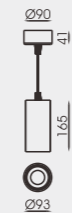

# RD3040A SERIES

Color selection  
B S W



Reflector color option



## RD3040A-10

Max. 10W

Operating Temp. : -30°C + 40°C

10W COB chip (DC250mA)

- 2700K/700lm CRI90
- 3000K/800lm CRI90
- 4000K/930lm CRI90
- 5000K/1020lm CRI80

Internal Driver: AC100-240V 50/60Hz

Driver performance: Non-dimmable/dimmable

Dimmer: 0~10v/Triac/Dali

Beam angle



Reflector color option



## RD3040A-24

Max. 24W

Operating Temp. : -30°C + 40°C

24W COB chip (DC600mA)

- 2700K/1750lm CRI90
- 3000K/1950lm CRI90
- 4000K/2200lm CRI90
- 5000K/2340lm CRI80

Internal Driver: AC100-240V 50/60Hz

Driver performance: Non-dimmable/dimmable

Dimmer: 0~10v/Triac/Dali

Beam angle

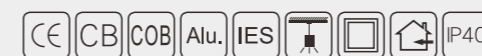

## LED CEILING DOWNLIGHT SERIES

Recessed led spotlight adopt integrated die casting lamp body design. Flexible replacement of reflector to reach different application effect.

Application: fashion shop, jewelry display and other high end accent lighting areas.

Symmetrical

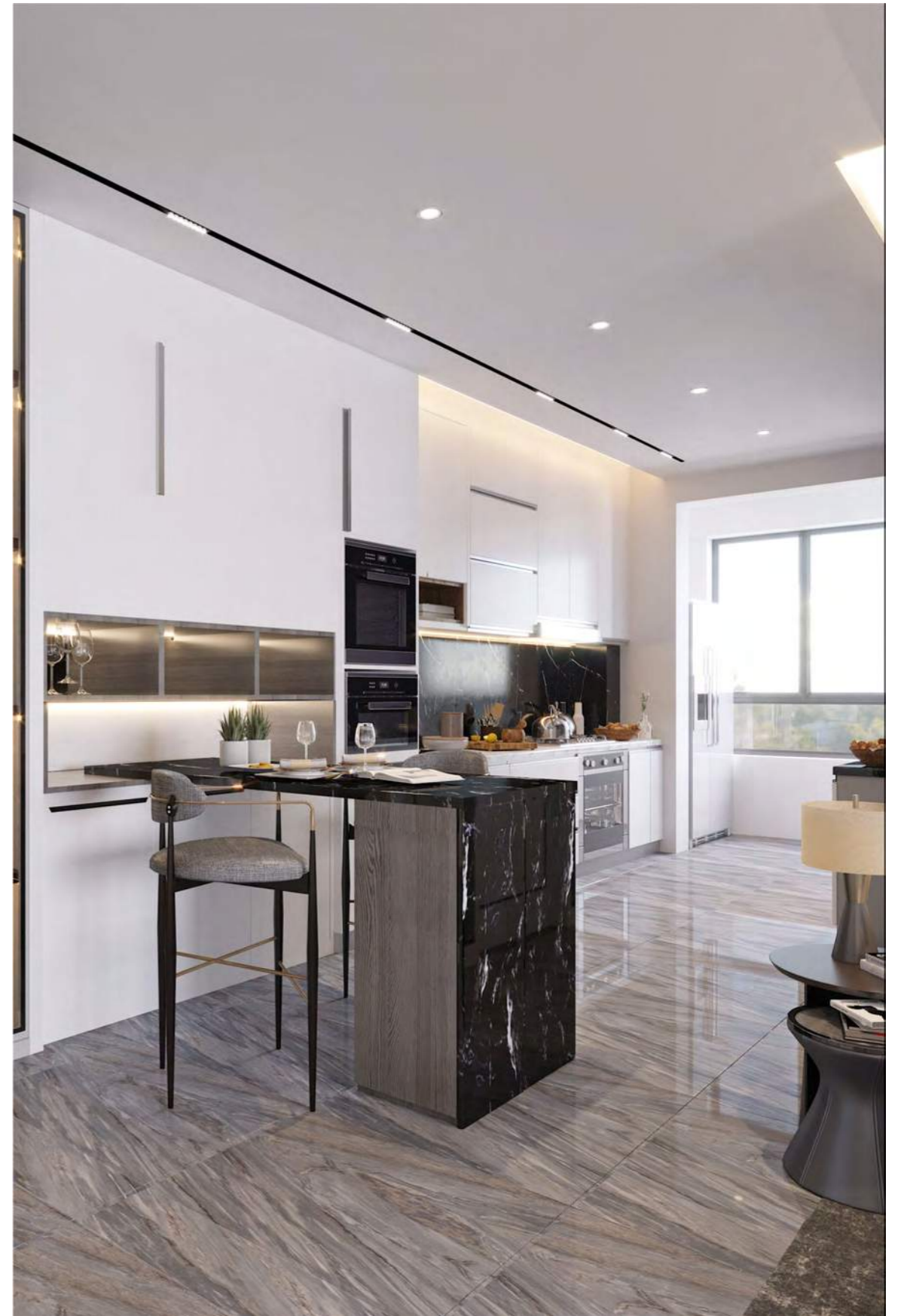

# RD1090 SERIES

Color selection 

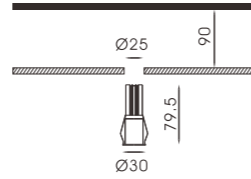

## RD1090-05 Max.5W

Power	LED InPut	CCT	Lm	CRI	Operating Temp
4.5W	DC1000mA	2700K	350lm	CRI90	-30°C+40°C
4.5W	DC1000mA	3000K	380lm	CRI90	-30°C+40°C
4.5W	DC1000mA	4000K	420lm	CRI90	-30°C+40°C
4.5W	DC1000mA	5000K	470lm	CRI80	-30°C+40°C

- Remote Driver: AC100-240V 50/60Hz
- Driver performance: Non-dimmable/dimmable
- Dimmer: DALI/0~10v/Triac
- Reflector color option



# RD1090 SERIES

Color selection 

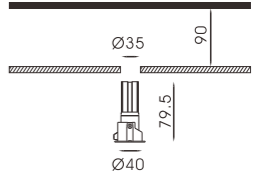

## RD1090A-05 Max.5W

Power	LED InPut	CCT	Lm	CRI	Operating Temp
4.5W	DC1000mA	2700K	350lm	CRI90	-30°C+40°C
4.5W	DC1000mA	3000K	380lm	CRI90	-30°C+40°C
4.5W	DC1000mA	4000K	420lm	CRI90	-30°C+40°C
4.5W	DC1000mA	5000K	470lm	CRI80	-30°C+40°C

- Remote Driver: AC100-240V 50/60Hz
- Driver performance: Non-dimmable/dimmable
- Dimmer: DALI/0~10v/Triac
- Reflector color option

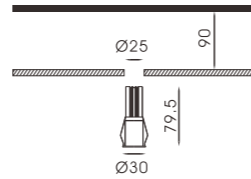

## RD1090-06 Max.6W

Power	LED InPut	CCT	Lm	CRI	Operating Temp
6W	DC1350mA	2700K	420lm	CRI90	-30°C+40°C
6W	DC1350mA	3000K	470lm	CRI90	-30°C+40°C
6W	DC1350mA	4000K	540lm	CRI90	-30°C+40°C
6W	DC1350mA	5000K	605lm	CRI80	-30°C+40°C

- Remote Driver: AC100-240V 50/60Hz
- Driver performance: Non-dimmable/dimmable
- Dimmer: DALI/0~10v/Triac
- Reflector color option

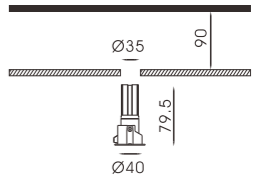

## RD1090A-06 Max.6W

Power	LED InPut	CCT	Lm	CRI	Operating Temp
6W	DC1350mA	2700K	420lm	CRI90	-30°C+40°C
6W	DC1350mA	3000K	470lm	CRI90	-30°C+40°C
6W	DC1350mA	4000K	540lm	CRI90	-30°C+40°C
6W	DC1350mA	5000K	605lm	CRI80	-30°C+40°C

- Remote Driver: AC100-240V 50/60Hz
- Driver performance: Non-dimmable/dimmable
- Dimmer: DALI/0~10v/Triac
- Reflector color option



# RD1091

## SERIES

Color selection 

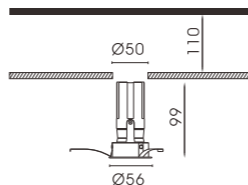

### RD1091-09

Max.9W

Power	LED InPut	CCT	Lm	CRI	Operating Temp
7.5W	DC200mA	2700K	635lm	CRI90	-30°C+40°C
7.5W	DC200mA	3000K	712lm	CRI90	-30°C+40°C
7.5W	DC200mA	4000K	792lm	CRI90	-30°C+40°C
7.5W	DC200mA	5000K	886lm	CRI80	-30°C+40°C

- Remote Driver: AC100-240V 50/60Hz
- Driver performance: Non-dimmable/dimmable
- Dimmer: DALI/0~10v/Triac
- Reflector color option



# RD1092

## SERIES

Color selection 

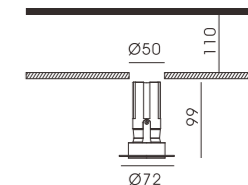

### RD1092-09

Max.9W

Power	LED InPut	CCT	Lm	CRI	Operating Temp
7.5W	DC200mA	2700K	635lm	CRI90	-30°C+40°C
7.5W	DC200mA	3000K	712lm	CRI90	-30°C+40°C
7.5W	DC200mA	4000K	792lm	CRI90	-30°C+40°C
7.5W	DC200mA	5000K	886lm	CRI80	-30°C+40°C

- Remote Driver: AC100-240V 50/60Hz
- Driver performance: Non-dimmable/dimmable
- Dimmer: DALI/0~10v/Triac
- Reflector color option

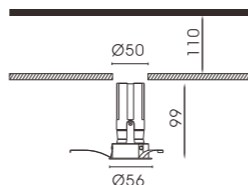

### RD1091A-09

Max.9W

Power	LED InPut	CCT	Lm	CRI	Operating Temp
7.5W	DC200mA	2700K	635lm	CRI90	-30°C+40°C
7.5W	DC200mA	3000K	712lm	CRI90	-30°C+40°C
7.5W	DC200mA	4000K	792lm	CRI90	-30°C+40°C
7.5W	DC200mA	5000K	886lm	CRI80	-30°C+40°C

- Remote Driver: AC100-240V 50/60Hz
- Driver performance: Non-dimmable/dimmable
- Dimmer: DALI/0~10v/Triac
- Reflector color option

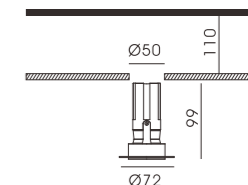

### RD1092A-09

Max.9W

Power	LED InPut	CCT	Lm	CRI	Operating Temp
7.5W	DC200mA	2700K	635lm	CRI90	-30°C+40°C
7.5W	DC200mA	3000K	712lm	CRI90	-30°C+40°C
7.5W	DC200mA	4000K	792lm	CRI90	-30°C+40°C
7.5W	DC200mA	5000K	886lm	CRI80	-30°C+40°C

- Remote Driver: AC100-240V 50/60Hz
- Driver performance: Non-dimmable/dimmable
- Dimmer: DALI/0~10v/Triac
- Reflector color option



# RD1093

## SERIES

Color selection 

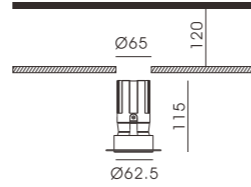

### RD1093-15

Max. 15W

Power	LED InPut	CCT	Lm	CRI	Operating Temp
15W	DC350mA	2700K	1050lm	CRI90	-30°C+40°C
15W	DC350mA	3000K	1170lm	CRI90	-30°C+40°C
15W	DC350mA	4000K	1305lm	CRI90	-30°C+40°C
15W	DC350mA	5000K	1440lm	CRI80	-30°C+40°C

- Remote Driver: AC100-240V 50/60Hz
- Driver performance: Non-dimmable/dimmable
- Dimmer: DALI/0~10v/Triac
- Reflector color option



# RD1094

## SERIES

Color selection 

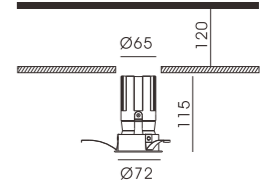

### RD1094-15

Max. 15W

Power	LED InPut	CCT	Lm	CRI	Operating Temp
15W	DC350mA	2700K	1050lm	CRI90	-30°C+40°C
15W	DC350mA	3000K	1170lm	CRI90	-30°C+40°C
15W	DC350mA	4000K	1305lm	CRI90	-30°C+40°C
15W	DC350mA	5000K	1440lm	CRI80	-30°C+40°C

- Remote Driver: AC100-240V 50/60Hz
- Driver performance: Non-dimmable/dimmable
- Dimmer: DALI/0~10v/Triac
- Reflector color option

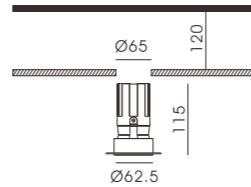

### RD1093A-15

Max. 15W

Power	LED InPut	CCT	Lm	CRI	Operating Temp
15W	DC350mA	2700K	1050lm	CRI90	-30°C+40°C
15W	DC350mA	3000K	1170lm	CRI90	-30°C+40°C
15W	DC350mA	4000K	1305lm	CRI90	-30°C+40°C
15W	DC350mA	5000K	1440lm	CRI80	-30°C+40°C

- Remote Driver: AC100-240V 50/60Hz
- Driver performance: Non-dimmable/dimmable
- Dimmer: DALI/0~10v/Triac
- Reflector color option

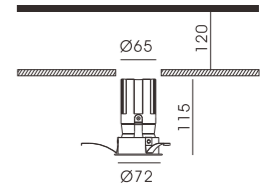

### RD1094A-15

Max. 15W

Power	LED InPut	CCT	Lm	CRI	Operating Temp
15W	DC350mA	2700K	1050lm	CRI90	-30°C+40°C
15W	DC350mA	3000K	1170lm	CRI90	-30°C+40°C
15W	DC350mA	4000K	1305lm	CRI90	-30°C+40°C
15W	DC350mA	5000K	1440lm	CRI80	-30°C+40°C

- Remote Driver: AC100-240V 50/60Hz
- Driver performance: Non-dimmable/dimmable
- Dimmer: DALI/0~10v/Triac
- Reflector color option





# RD2040 SERIES

Color selection 

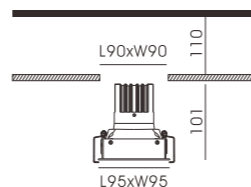
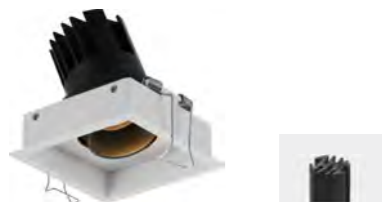

## RD2040-15 Max.15W

Power	LED InPut	CCT	Lm	CRI	Operating Temp
15W	DC350mA	2700K	1050lm	CRI90	-30°C+40°C
15W	DC350mA	3000K	1170lm	CRI90	-30°C+40°C
15W	DC350mA	4000K	1305lm	CRI90	-30°C+40°C
15W	DC350mA	5000K	1440lm	CRI80	-30°C+40°C

- Remote Driver: AC100-240V 50/60Hz
- Driver performance: Non-dimmable/dimmable
- Dimmer: DALI/0~10v/Triac



# RD2041 SERIES

Color selection 

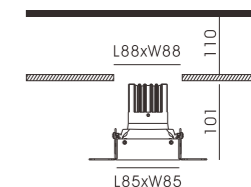
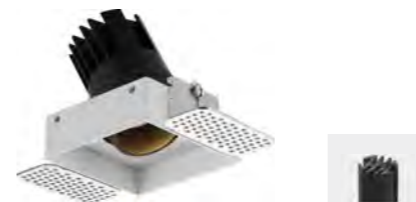

## RD2041-15 Max.15W

Power	LED InPut	CCT	Lm	CRI	Operating Temp
15W	DC350mA	2700K	1050lm	CRI90	-30°C+40°C
15W	DC350mA	3000K	1170lm	CRI90	-30°C+40°C
15W	DC350mA	4000K	1305lm	CRI90	-30°C+40°C
15W	DC350mA	5000K	1440lm	CRI80	-30°C+40°C

- Remote Driver: AC100-240V 50/60Hz
- Driver performance: Non-dimmable/dimmable
- Dimmer: DALI/0~10v/Triac

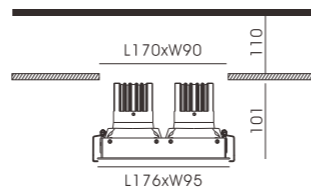

## RD2040-30 Max.30W

Power	LED InPut	CCT	Lm	CRI	Operating Temp
30W	DC700mA	2700K	2107lm	CRI90	-30°C+40°C
30W	DC700mA	3000K	2340lm	CRI90	-30°C+40°C
30W	DC700mA	4000K	2645lm	CRI90	-30°C+40°C
30W	DC700mA	5000K	2943lm	CRI80	-30°C+40°C

- Remote Driver: AC100-240V 50/60Hz
- Driver performance: Non-dimmable/dimmable
- Dimmer: DALI/0~10v/Triac

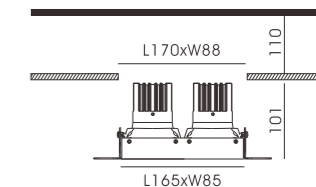

## RD2041-30 Max.30W

Power	LED InPut	CCT	Lm	CRI	Operating Temp
30W	DC700mA	2700K	2107lm	CRI90	-30°C+40°C
30W	DC700mA	3000K	2340lm	CRI90	-30°C+40°C
30W	DC700mA	4000K	2645lm	CRI90	-30°C+40°C
30W	DC700mA	5000K	2943lm	CRI80	-30°C+40°C

- Remote Driver: AC100-240V 50/60Hz
- Driver performance: Non-dimmable/dimmable
- Dimmer: DALI/0~10v/Triac







# LED CEILING DOWNLIGHT SERIES

Recessed led spotlight adopt integrated die casting lamp body design. Flexible replacement of reflector to reach different application effect.

Application: fashion shop, jewelry display and other high end accent lighting areas.



## Configuration



**Asymmetric optics**  
wallwasher

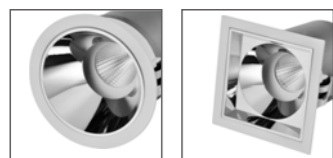

**symmetrical**  
16°/ 26°/ 35°

## Reflector color option

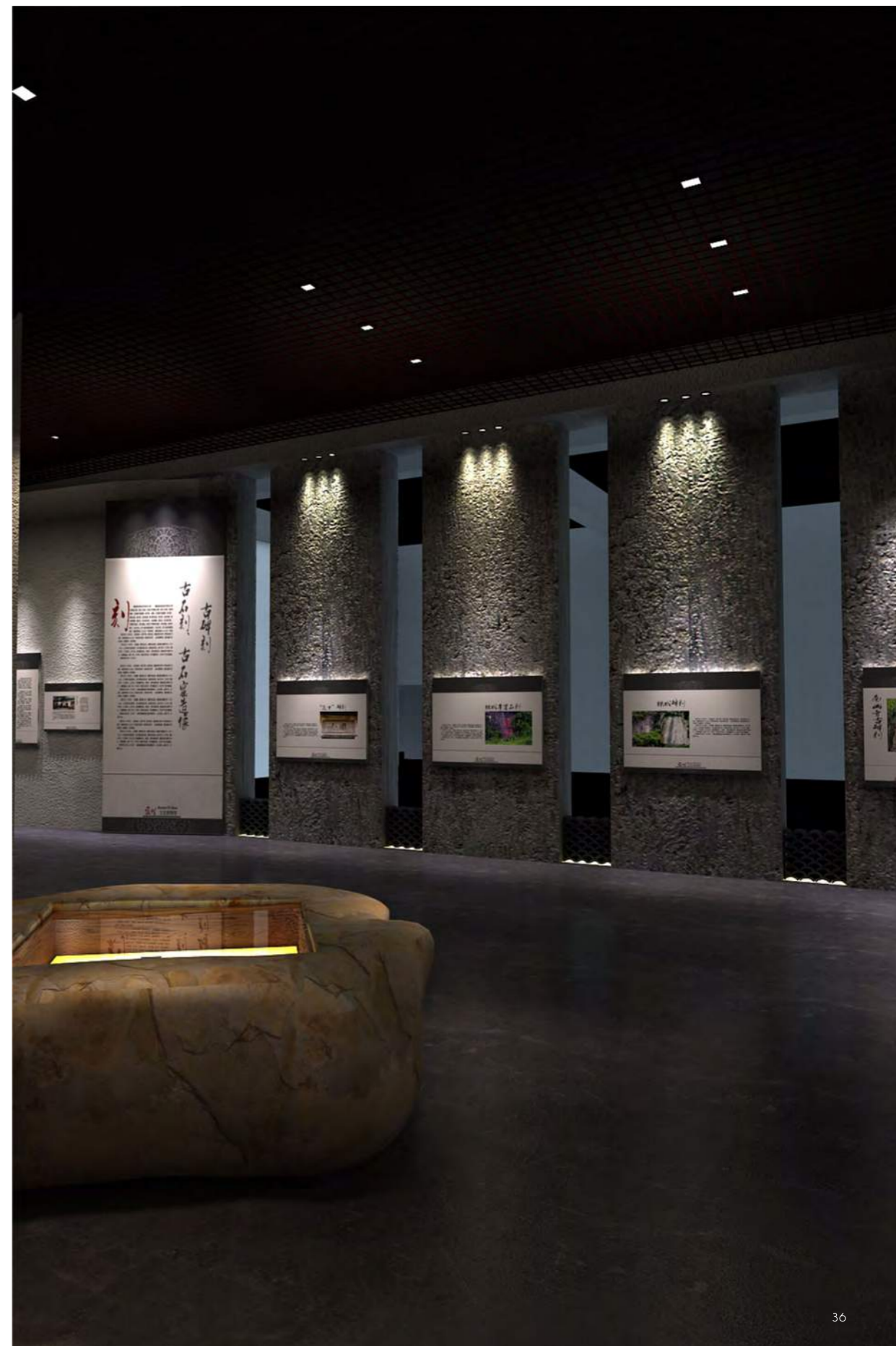

# RD5207 SERIES

Color selection  
B S W

RD5207-20

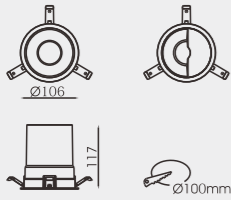

RD5207A-20

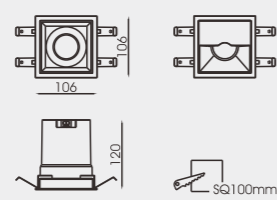

	Power	LED InPut	CCT	Lm	CRI	Operating Temp
<b>RD5207-20</b> Max.20W	20W	DC500mA	2700K	1400lm	CRI90	-30°C+40°C
	20W	DC500mA	3000K	1600lm	CRI90	-30°C+40°C
	20W	DC500mA	4000K	1850lm	CRI90	-30°C+40°C
	20W	DC500mA	5000K	2100lm	CRI80	-30°C+40°C

- Remote Driver: AC100-240V 50/60Hz
- Driver performance: Non-dimmable/dimmable
- Dimmer: DALI/0~10v/Triac



# RD5207 SERIES

Color selection  
B S W

RD5207-08

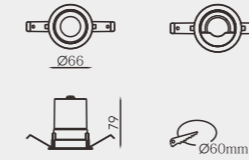

RD5207A-08

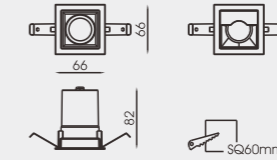

	Power	LED InPut	CCT	Lm	CRI	Operating Temp
<b>RD5207-08</b> Max.8W	7W	DC200mA	2700K	580lm	CRI90	-30°C+40°C
	7W	DC200mA	3000K	650lm	CRI90	-30°C+40°C
	7W	DC200mA	4000K	720lm	CRI90	-30°C+40°C
	7W	DC200mA	5000K	760lm	CRI80	-30°C+40°C

- Remote Driver: AC100-240V 50/60Hz
- Driver performance: Non-dimmable/dimmable
- Dimmer: DALI/0~10v/Triac



RD5207-15

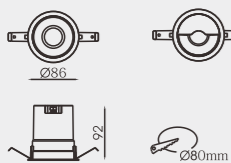

RD5207A-15

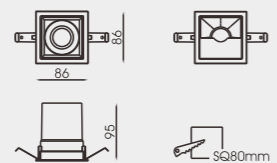

	Power	LED InPut	CCT	Lm	CRI	Operating Temp
<b>RD5207-15</b> Max.15W	15W	DC350mA	2700K	1090lm	CRI90	-30°C+40°C
	15W	DC350mA	3000K	1220lm	CRI90	-30°C+40°C
	15W	DC350mA	4000K	1350lm	CRI90	-30°C+40°C
	15W	DC350mA	5000K	1425lm	CRI80	-30°C+40°C

- Remote Driver: AC100-240V 50/60Hz
- Driver performance: Non-dimmable/dimmable
- Dimmer: DALI/0~10v/Triac





# LED CEILING DOWNLIGHT SERIES

Recessed LED adjustable spot light with high purity molding, excellent and life-guaranteed heat sink design, 360° horizontally 45° tilt provides flexible projection demand.

Application: fashion shop, jewelry display and other high end accent lighting areas.

### Reflector color option



### Beam angle

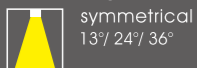

## RD1083 SERIES

Color selection  
B S W

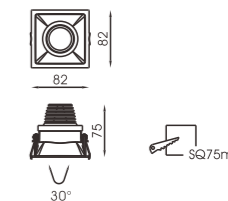

### RD1083A-06 Max.6W

Power	LED InPut	CCT	Lm	CRI	Operating Temp
6W	DC500mA	2700K	350lm	CRI90	-30°C+40°C
6W	DC500mA	3000K	430lm	CRI90	-30°C+40°C
6W	DC500mA	4000K	500lm	CRI90	-30°C+40°C
6W	DC500mA	5000K	510lm	CRI80	-30°C+40°C

- Remote Driver: AC100-240V 50/60Hz
- Driver performance: Non-dimmable/dimmable
- Dimmer: DALI/0~10v/Triac

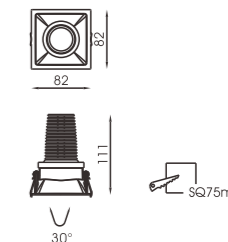

### RD1083-13 Max.13W

Power	LED InPut	CCT	Lm	CRI	Operating Temp
13W	DC300mA	2700K	700lm	CRI90	-30°C+40°C
13W	DC300mA	3000K	850lm	CRI90	-30°C+40°C
13W	DC300mA	4000K	1020lm	CRI90	-30°C+40°C
13W	DC300mA	5000K	1100lm	CRI80	-30°C+40°C

- Remote Driver: AC100-240V 50/60Hz
- Driver performance: Non-dimmable/dimmable
- Dimmer: DALI/0~10v/Triac



# RD5218/RD5208 SERIES

Color selection  
B S W

## RD5218-10

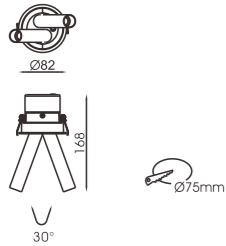

## RD5218A-10

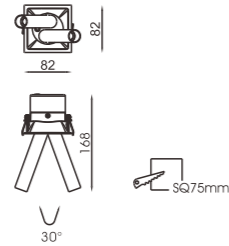

## Beam angle



### RD5218-10 Max. 2x5W

Power	LED InPut	CCT	Lm	CRI	Operating Temp
2x5W	DC500mA	2700K	400lm	CRI90	-30°C+40°C
2x5W	DC500mA	3000K	430lm	CRI90	-30°C+40°C
2x5W	DC500mA	4000K	490lm	CRI90	-30°C+40°C
2x5W	DC500mA	5000K	550lm	CRI80	-30°C+40°C

- Remote Driver: AC100-240V 50/60Hz
- Driver performance: Non-dimmable/dimmable
- Dimmer: DALI/0~10v/Triac



## RD5208-06

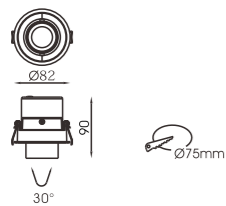

## RD5208A-06

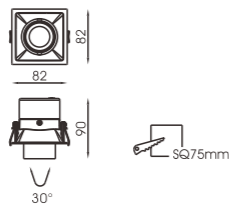

## Beam angle

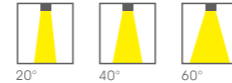

### RD5208-06 Max. 6W

Power	LED InPut	CCT	Lm	CRI	Operating Temp
6W	DC500mA	2700K	350lm	CRI90	-30°C+40°C
6W	DC500mA	3000K	430lm	CRI90	-30°C+40°C
6W	DC500mA	4000K	500lm	CRI90	-30°C+40°C
6W	DC500mA	5000K	510lm	CRI80	-30°C+40°C

- Remote Driver: AC100-240V 50/60Hz
- Driver performance: Non-dimmable/dimmable
- Dimmer: DALI/0~10v/Triac



LED CEILING DOWNLIGHT



# RD5210

SERIES

Circular

The series luminaires with deep anti-glare, **IP54** protection and 90mm~135mm diameter range option, suitable for different application scenarios



**RD5210**  
(S)



**RD5210**  
(M)



**RD5210**  
(L)

# RD5210A

SERIES

Square



**RD5210A**  
(S)



**RD5210A**  
(M)



**RD5210A**  
(L)

# LED CEILING DOWNLIGHT SERIES

Ultra-narrow trim with deep anti-glare design fixture make your decoration effect more artistic and modern ,simple ,elegant unique application. Square and round for selection.

Application: fashion shop, jewelry display and other high end accent lighting areas.



Reflector color option



# RD5210 SERIES

Color selection  
B S W

RD5210-24



RD5210A-24

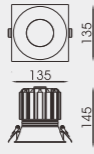

Beam angle



## RD5210-24 Max. 24W

Power	LED InPut	CCT	Lm	CRI	Operating Temp
24W	DC600mA	2700K	1872lm	CRI90	-30°C+40°C
24W	DC600mA	3000K	1920lm	CRI90	-30°C+40°C
24W	DC600mA	4000K	2000lm	CRI90	-30°C+40°C
24W	DC600mA	5000K	2040lm	CRI80	-30°C+40°C

- Remote Driver: AC100-240V 50/60Hz
- Driver performance: Non-dimmable/dimmable
- Dimmer: DALI/0~10v/Triac



# RD5210 SERIES

Color selection  
B S W

RD5210-08



RD5210A-08

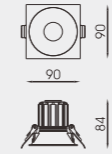

Beam angle



## RD5210-08 Max. 8W

Power	LED InPut	CCT	Lm	CRI	Operating Temp
8W	DC200mA	2700K	635lm	CRI90	-30°C+40°C
8W	DC200mA	3000K	712lm	CRI90	-30°C+40°C
8W	DC200mA	4000K	792lm	CRI90	-30°C+40°C
8W	DC200mA	5000K	886lm	CRI80	-30°C+40°C

- Remote Driver: AC100-240V 50/60Hz
- Driver performance: Non-dimmable/dimmable
- Dimmer: DALI/0~10v/Triac



RD5210-15



RD5210A-15



Beam angle



## RD5210-15 Max. 15W

Power	LED InPut	CCT	Lm	CRI	Operating Temp
15W	DC350mA	2700K	1120lm	CRI90	-30°C+40°C
15W	DC350mA	3000K	1286lm	CRI90	-30°C+40°C
15W	DC350mA	4000K	1440lm	CRI90	-30°C+40°C
15W	DC350mA	5000K	1568lm	CRI80	-30°C+40°C

- Remote Driver: AC100-240V 50/60Hz
- Driver performance: Non-dimmable/dimmable
- Dimmer: DALI/0~10v/Triac



# LED CEILING DOWNLIGHT SERIES

It's made up of mini grilles alternate the intermediate module to make completely symmetrical light and partial asymmetrical combination with Bluetooth controller luminaries.



using bluetooth controller  
App store: allumin

## Configuration



2 X wallwasher

3 X symmetrical

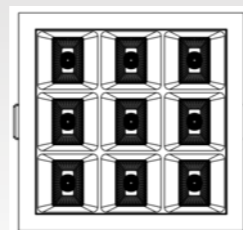

9 X symmetrical

## RD5206 SERIES

Color selection  
B S W

### RD5206-40

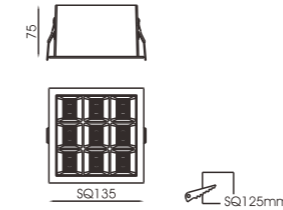

Beam angle  
Symmetrical  
13°/24°/36°



	Power	LED InPut	CCT	Lm	CRI	Operating Temp
<b>RD5206-40</b> Max.40W	40W	DC1500mA	2700K	2815lm	CRI90	-30°C+40°C
	40W	DC1500mA	3000K	3120lm	CRI90	-30°C+40°C
	40W	DC1500mA	4000K	3520lm	CRI90	-30°C+40°C
	40W	DC1500mA	5000K	3925lm	CRI80	-30°C+40°C

- Remote Driver: AC100-240V 50/60Hz
- Driver performance: Non-dimmable/dimmable
- Dimmer: DALI/0~10v/Triac



### RD5206A-40

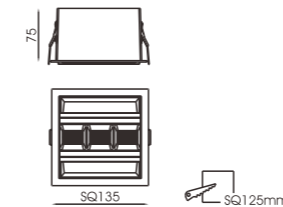

Beam angle  
2 X Wallwasher  
3X Symmetrical  
12°/23°/38°/50°/35°/75°/50°/50°/70°/70°



	Power	LED InPut	CCT	Lm	CRI	Operating Temp
<b>RD5206A-40</b> Max.40W	40W	Middile Part DC500mA Two side wall washer DC1000mA	2700K	2815lm	CRI90	-30°C+40°C
			3000K	3120lm	CRI90	-30°C+40°C
			4000K	3520lm	CRI90	-30°C+40°C
			5000K	3925lm	CRI80	-30°C+40°C

- Remote Driver: AC100-240V 50/60Hz
- Driver performance: Non-dimmable/dimmable
- Dimmer: DALI/0~10v/Triac







RD3041

## LED DROPLINE LAMP

Ultra-narrow trim with deep anti-glare design fixture make your decoration effect more artistic and modern ,simple ,elegant unique application.  
Square and round for selection.

Application: fashion shop, jewelry display and other high end accent lighting areas.

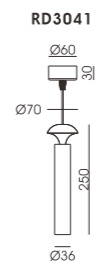



**RD3041**

10W

Ø36xL250mm

600mm (Pendant lamp)

Black/White



15°



**RD3041-3**

10Wx3

Ø36xL250mm

600mm (Pendant lamp)

Black/White



15°









RD1001Z

## LED DROPLINE LAMP

Ultra-narrow trim with deep anti-glare design fixture make your decoration effect more artistic and modern ,simple ,elegant unique application.  
Square and round for selection.

Application: fashion shop, jewelry display and other high end accent lighting areas.

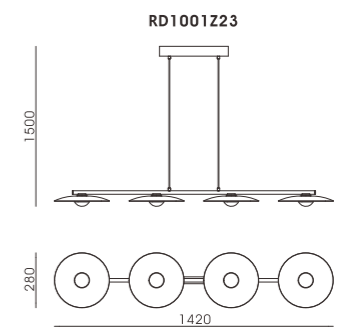
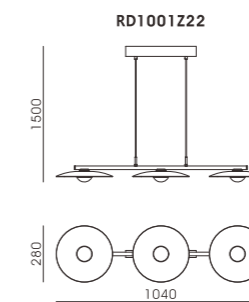
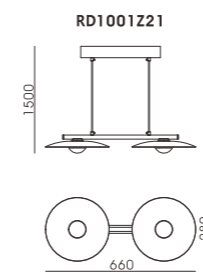



**RD1001Z23**

20W

L660xW280xH1500mm

600mm (Pendant lamp)

Black



120°





**RD1001Z22**

30W  
 L11040xW280xH1500mm  
 600mm (Pendant lamp)  
 Black



120°



**RD1001Z23**

40W  
 L1420xW280xH1500mm  
 600mm (Pendant lamp)  
 Black



120°



RD2001Z



## LED SURFACE MOUNTED PENDANT LIGHT SERIES

Led surface mounted pendant light with high quality die casting alumnaires.  
simple design structure make elegant application visual effect and the  
efficiency of heat dissipation

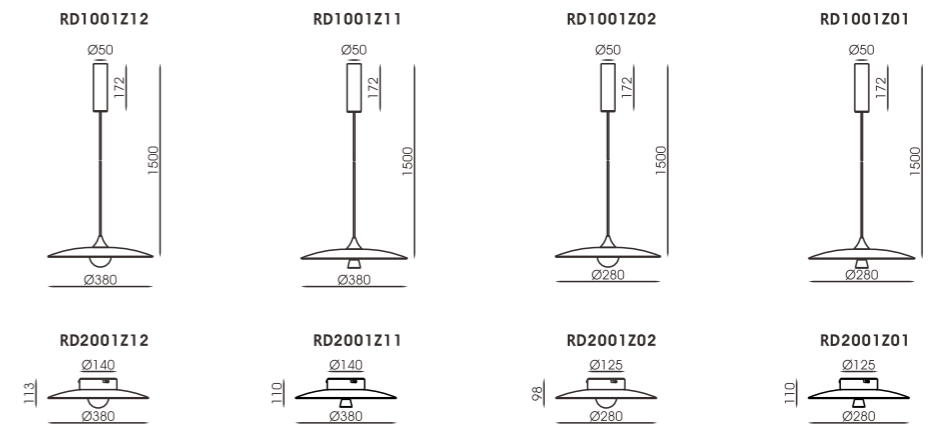



**RD1001Z12**

20W  
Ø380xH1500mm  
1200mm (Pendant lamp)  
Black



120°

**RD2001Z12**

20W  
Ø380xH113mm  
Ceiling lamp  
Black



120°

**RD1001Z02**

15W  
Ø280xH1500mm  
1200mm (Pendant lamp)  
Black



120°

**RD2001Z02**

15W  
Ø280xH98mm  
Ceiling lamp  
Black



120°

**RD1001Z11**

20W  
Ø380xH1500mm  
1200mm (Pendant lamp)  
Black



90°

**RD2001Z11**

20W  
Ø380xH110mm  
Ceiling lamp  
Black



90°

**RD1001Z01**

20W  
Ø280xH1500mm  
1200mm (Pendant lamp)  
Black



90°

**RD2001Z01**

20W  
Ø280xH110mm  
Ceiling lamp  
Black



90°







RD1004Z

# LED SURFACE MOUNTED PENDANT LIGHT SERIES

Led surface mounted pendant light with high quality die casting alumnaires. simple design structure make elegant application visual effect and the efficiency of heat dissipation

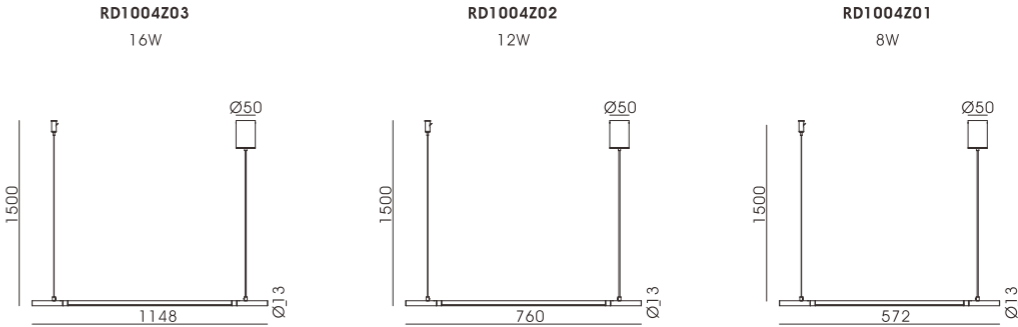



Ultra-narrow trim with deep anti-glare design fixture make your decoration effect more artistic and modern ,simple ,elegant unique application.  
Square and round for selection.





RD3004Z

## LED WALL LAMP SERIES

Led surface mounted light with high quality die casting alumnaires.simple design structure make elegant application visual effect and the efficiency of heat dissipation

**RD3004Z13**  
16W  
Black

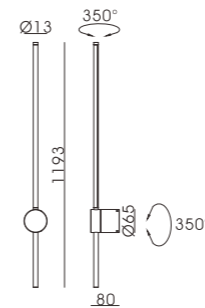

**RD3004Z12**  
12W  
Black

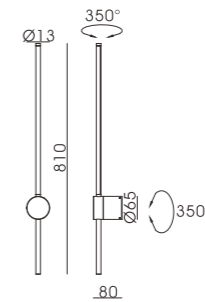

**RD3004Z11**  
8W  
3Black

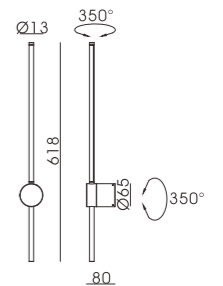





RD3004Z

## LED WALL LAMP SERIES

Led surface mounted light with high quality die casting alumnaries.simple design structure make elegant application visual effect and the efficiency of heat dissipation

**RD3004Z03**  
16W  
Black/Golden

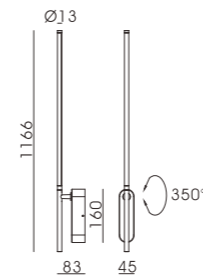

**RD3004Z02**  
12W  
Black/Golden

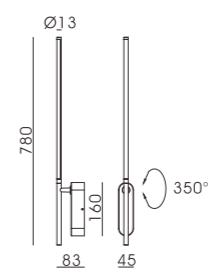

**RD3004Z01**  
8W  
Black/Golden

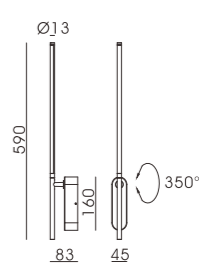





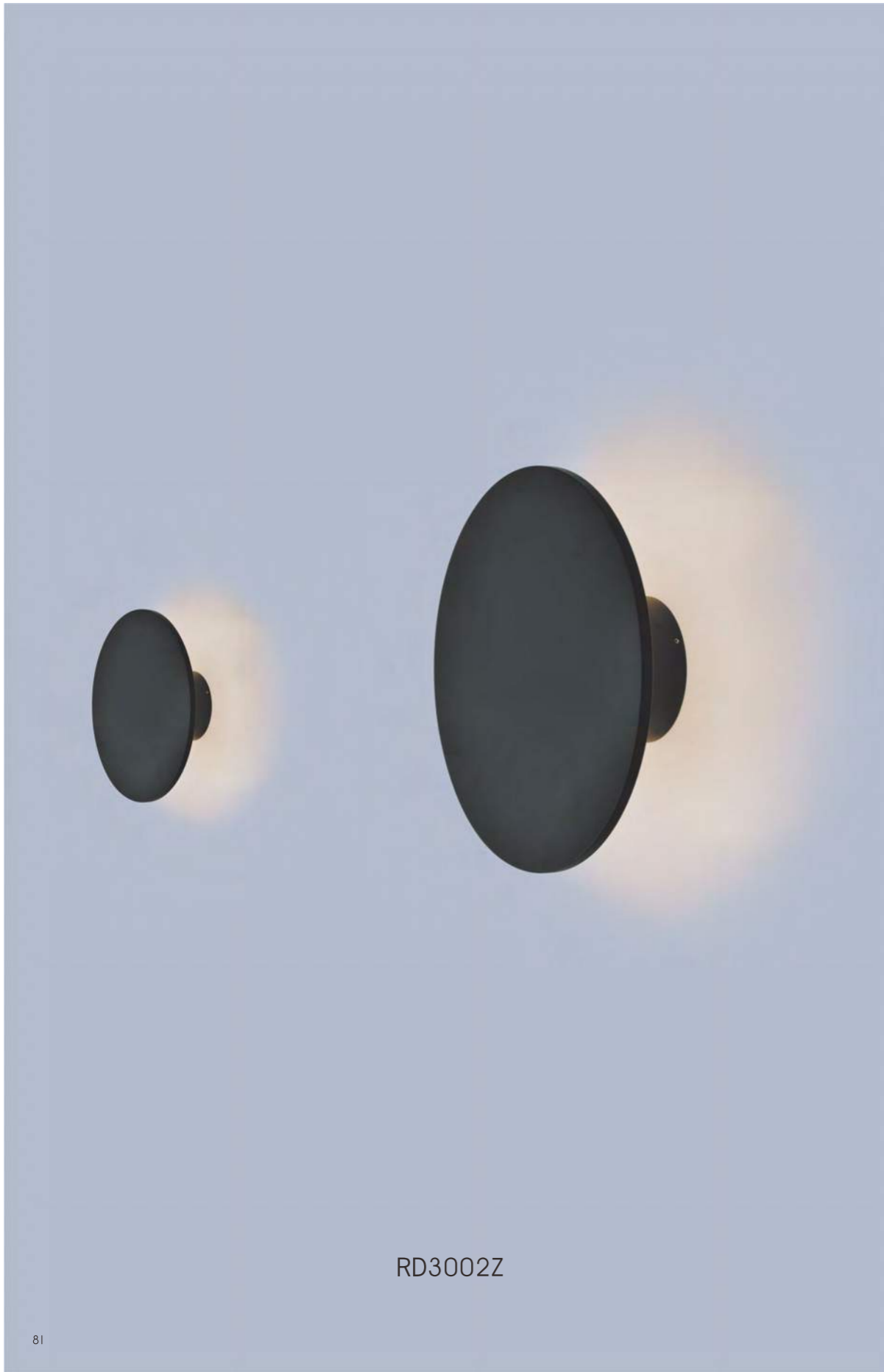

## LED WALL LAMP SERIES

Led surface mounted light with high quality die casting alumnaires.simple design structure make elegant application visual effect and the efficiency of heat dissipation

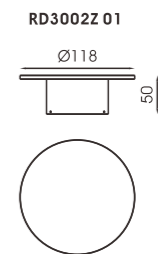
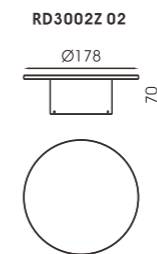
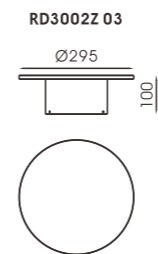



**RD3002Z 03**

30W  
Ø295xH100mm  
Wall lamp  
Black/White  
IP65



120°



**RD3002Z 02**

12W  
Ø178xH70mm  
Wall lamp  
Black/White  
IP65



120°



**RD3002Z 01**

6W  
Ø118xH50mm  
Wall lamp  
Black/White  
IP65



120°

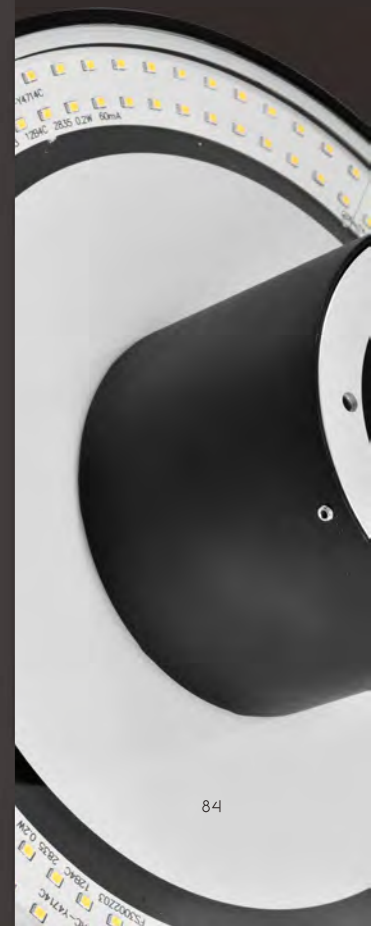







RD3001Z 01

## LED WALL LAMP SERIES

Led surface mounted light with high quality die casting alumnaries.simple design structure make elegant application visual effect and the efficiency of heat dissipation

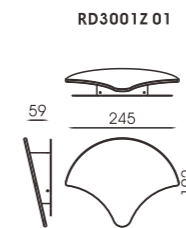



**RD3001Z 01**  
10W  
L245xW192xH59mm  
Black