

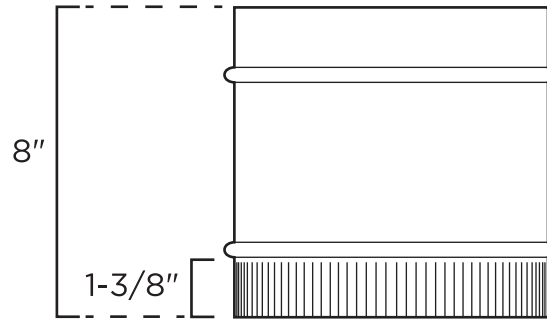

N.T.S.

TOP VIEW



FRONT VIEW

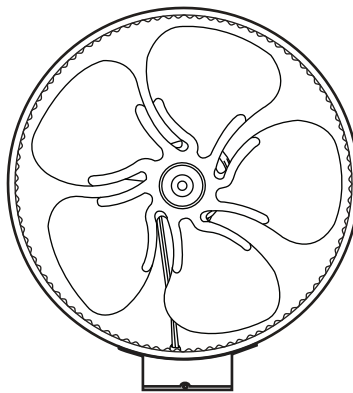

SIDE VIEW

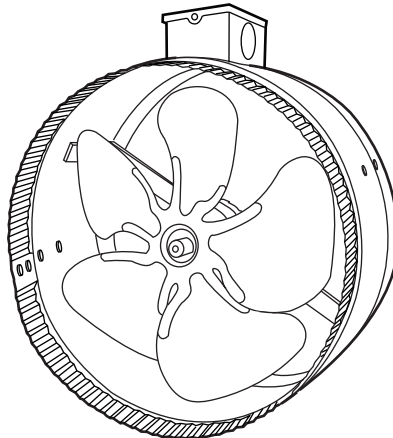
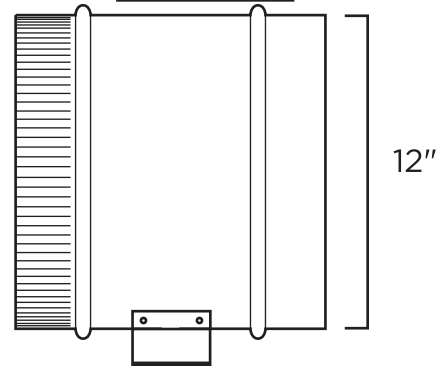

MODEL: DB412E

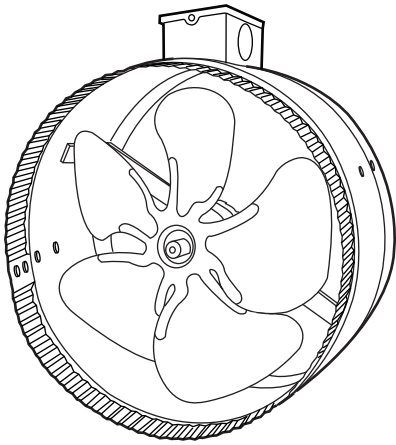

Model: DB412E

12" 4-Pole Inductor® In-Line Duct Fan™

180 Running Watts, 1.57 Amps, 120 VAC, 60 Hz

UL® Listed Thermally Protected Motor

1 Year Limited Warranty

12" Diameter

Blade Type: Aluminum

Assembled in the USA

Primary UOM: EA

Shipping Multiple: 2

PERFORMANCE:

Max Boosted CFM	Free Air CFM	Watts	Amps	Volts	Hz	dBA	Sones	Unit Weight
1160	700	180	1.57	120	60	61	4.4	5.60lbs

HAZARDOUS MATERIAL INFO:

Not Applicable

CUSTOMS TARIFF CLASSIFICATION:

HS Code	Country of Origin	NAFTA Preference Criterion	NAFTA Producer Index
8414596090	USA	B	Y

PACKAGING METRICS:

	UPC / SCC	WIDTH (in)	HEIGHT (in)	DEPTH (in)	WEIGHT (lbs)
Unit (1qty):	066028000897	12.25	13.00	8.50	6.25
Master Case (2qty):	40066028000888	19.25	13.50	12.75	13.00

MODEL: DB412E