



# TANACOM 1200

---

Instruction Manual

# Index

Caution-----1-9

Power source-----10-12

- How to connect the power source 10
- About the power source 11
- Battery level indicator 12

Maintenance-----13,14

- About maintenance 13
- Maintenance procedure 13
- Handling and maintenance of the power cord 14
- Maintenance of the power cord 14
- Other maintenance points 14

Names and functions of each part-----15,16

Names of the buttons and the display -----17

Preparation -----18

Functional setting-----19-39

1. How to operate the Menu screen -----19,20
  - Setting of useful functions 19,20
2. LINE DATA INPUT -----21-30
  - P1 When line length is known 21-23
  - P2 With backing line 24-27
  - P3 Backing line 2 28-30
3. Before start fishing-----31
  - Water surface zero setting 31
  - If the main line is broken 31
4. Auto stop-----32
  - Adjustable auto stop setting 32
5. INVERSE COUNTER -----33
6. Line feeding function -----34
7. Chumming Timer -----35
8. HISTORY -----36
9. Other useful functions-----37,38
  - Various alarms 37
  - ALARM ON/OFF setting 37
  - LANGUAGE(言語) setting 38
  - UNIY setting 38
  - Counter lamp 38
  - Circuit breaker display 38
10. How to remove the handle knob-----39

How to fix the Rod Clamp-----40

Reel Specifications-----41

- Reel Specification list 41
- Counter display 41

Parts List-----42,43

Trouble shooting-----44

## List of options for line data input

This reel can be configured and set-up using the following options.

**P1 When line length is known 21-23**  
This option allows you to set useful functions when you know the length of the fishing line to be wound on the reel.

**P2 With backing line 24-27**  
This option allows you to set functions to insert a backing line. Note that it is necessary that you know the line length and that it is greater than 100 m.



**P3 Backing line 2 28-30**  
This option allows you to re-enter the line data, pulling out the line after it has been completely wound up onto the reel. Note that it is necessary that you know the line length and that it is greater than 100 m.

Thank you for purchasing a TANACOM1200. Please read this operation manual carefully and use the product safely and correctly to take full advantage of this electric reel with many convenient features for your on-board fishing. Please keep this operation manual carefully together with your reel for your future reference.

# Caution

This document contains important instructions for using your electric reel. Please be sure to read them thoroughly before use. Note that we will not warrant for any use of the product without reading the Instruction Manual and the "Warning List" supplied with the product before use.

## About the signs

- |   |   |
|---|---|
|  | This sign means "prohibited actions." Within the area or near this sign, specific prohibited actions are described.                     |
|  | This sign means "actions that require caution." Within the area or near this sign, specific actions that require caution are described. |
|  | This sign means "mandatory actions." Within the area of this sign, specific mandatory actions are described.                            |

## **WARNING**

The following pertains to matters that could cause problems or serious, even life-threatening injuries should the instructions be ignored or incorrectly followed.

-Be careful not to catch your fingers between the reel and the level wind, which is used to wind line into the spool evenly. It may cause injury.

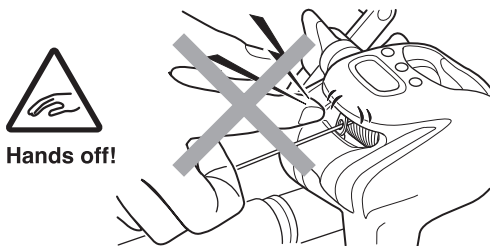

-When you turn on the clutch while feeding line (operated by the motor), it winds up the line. Be careful not to catch your fingers. It may cause injury.

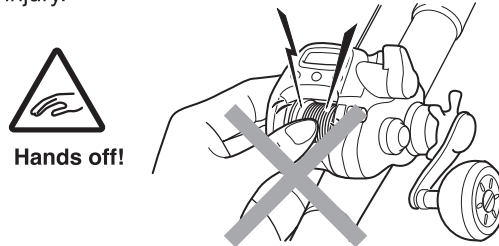

-Keep your eyes on your reel during use. Failure to do so may result in an unexpected accident or injury.

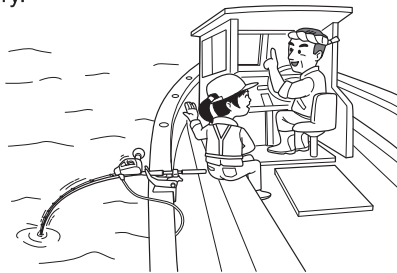

-For a big game fishing using large sized electric reel, make sure to fix the reel properly and firmly to the rod clamp or the holder. Failing to fix it firmly may result in an unexpected accident or injury.

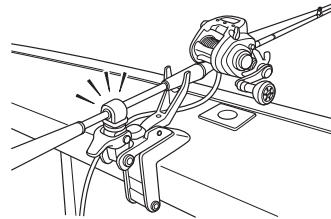

-Do not use the reel in an unbalanced and unnatural stance. Stand with your feet planted firmly on the ground to give you a balanced stance.

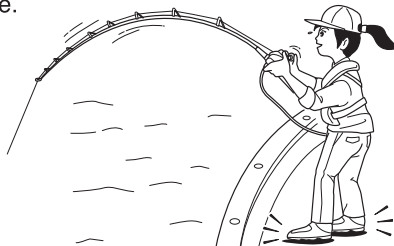

-Adults or parent's must supervise closely any use of this product by children. Use extreme caution to keep their fingers and hands away from moving parts or openings in the reel.

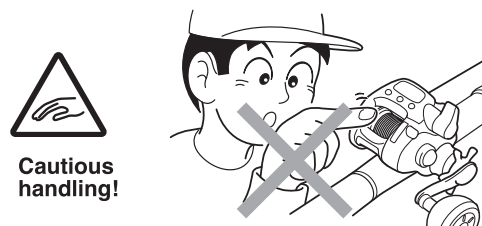

# Caution

## WARNING

The following pertains to matters that could cause problems or serious, even life-threatening injuries, should the instructions be ignored or incorrectly followed.

-Wear appropriate clothes and equipment during use. When you are not careful, you may be caught in the rotating parts or injured due to flying debris, resulting in serious injury or disability.

1. Keep your hair, clothing, and or gloves away from the rotating parts.
2. Wear non-slip footwear.
3. Cover long hair with a cap or hair cover.
4. Do not wear necklaces, neckties, or other jewelry and accessories that may be caught unexpectedly.
5. Be sure to wear equipment that protects your eyes, such as polarized glasses or eyeglasses.

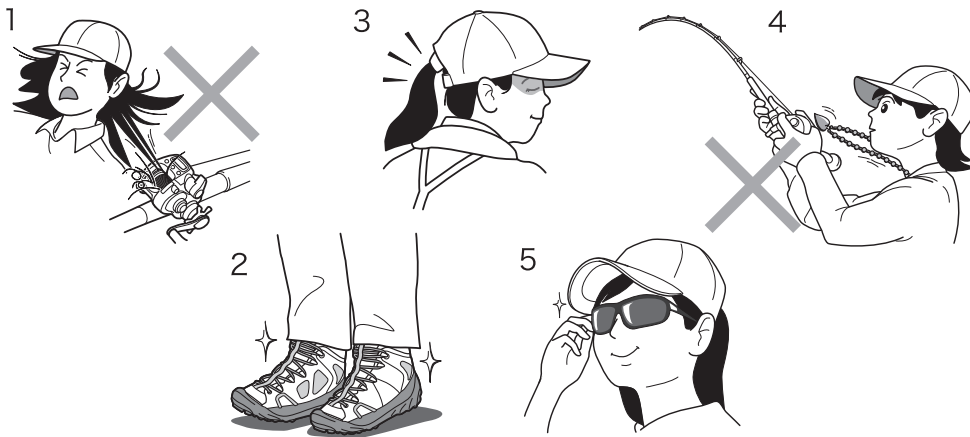

-Do not use and keep this product within the reach of children. Keep out of reach of children for storing or use of the product, as well as the reel itself, the packaged items and accessories.



**Secure storage!**



-When using batteries or the power supply of a boat, only apply the designated voltage. Other voltage may cause an abnormally high temperature in the electric reel, that could burn your hand or damage the microchip. Do not connect to house current or any AC (alternating current) power supply. The circuit may be short-circuited and result in smoke and fire.

-While using an electric reel, weak radio waves will be generated, which may affect medical equipment, such as malfunction of hearing aids and pacemakers. In particular for a person implanted with a heart pacemaker, use of electric reel may cause palpitations or dizziness; Do Not use this product.



**Do not use!**



**Do not use!**

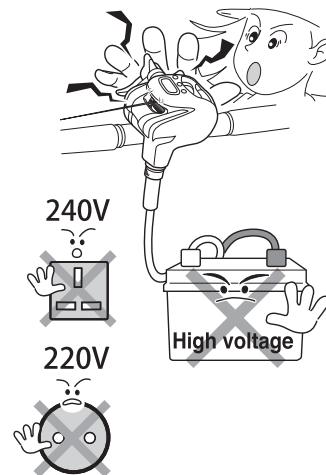

# Caution

## WARNING

The following pertains to matters that could cause problems or serious, even life-threatening injuries, should the instructions be ignored or incorrectly followed.

-Do not immerse the battery in a conductive material such as water. Doing so may cause the battery to be shorted out, resulting in damage, fire or getting burned.



-Do not fasten an electric reel with a harness onto your body. You may risk your life if pulled into the seawater by a big fish or in other situations.



Do not use!



-Keep the reel, cords, and batteries away from combustible materials and flammable substances (liquids, gases, and powder dust) to prevent ignition or explosion.

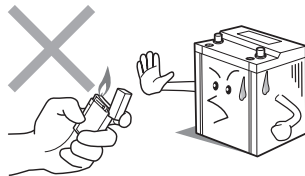

-Should the motor fail to stop for some reason while fishing, use caution to prevent your fingers being caught in the reel. Disconnect the power supply immediately.

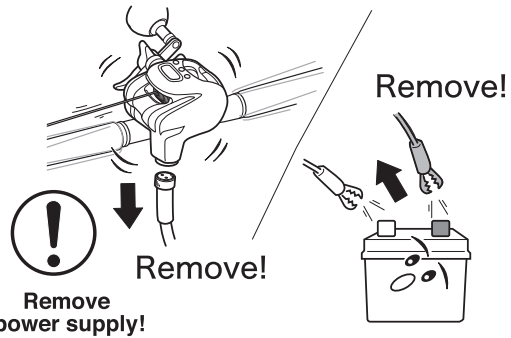

-Ensure to fix the electric reel securely to the reel seat before use. Do not use the reel if it is seated unsteadily and rattled or if it cannot be fixed firmly. If the reel comes off during fishing, you may be injured.

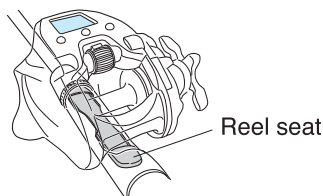

-Do Not connect the reel with the battery and or the cord when your hands are wet. Failure to do so may result in electric shock. If you connect it during rain, wipe your hands with a dry towel or the like and connect it quickly.

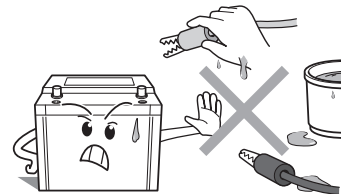

-Be careful not to get the power cord wrapped around your body. Failure to do so may result in getting dragged into the sea.



Cautious handling!

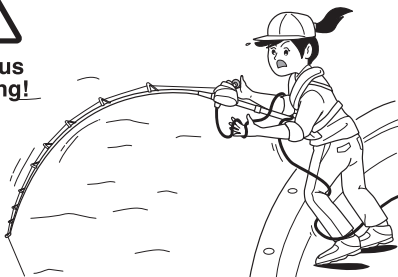

-Do not touch moving parts while in operation. It may cause injuries.



Hands off!

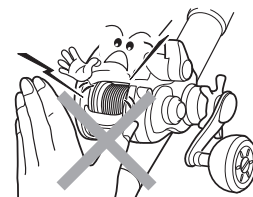

# Caution

## ! WARNING

The following pertains to matters that could cause problems or serious, even life-threatening injuries, should the instructions be ignored or incorrectly followed.

-Follow the national and local regulations to dispose of the product and battery.

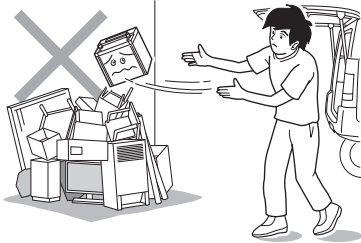

-When you do not use the product for fishing, turn off the winding lever and power supply. Failure to do so may result in unintended operation of the product, resulting in injury or other problems.

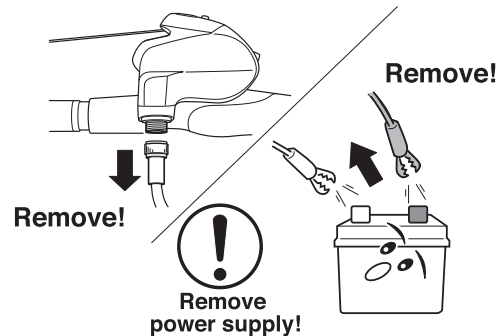

-Be sure to turn OFF the auto-wind lever before setting the dragging power. Failure to do so may result in your hand getting cut by the line while you are pulling it manually for setting the dragging power.

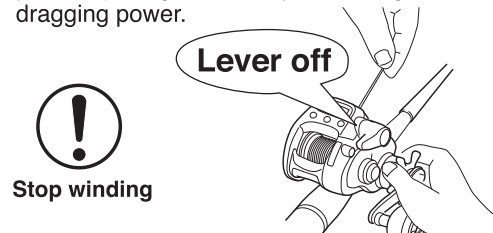

-Depending on the conditions of use or storage of the product, the cord may break or be shorted out, resulting in smoke or fire. Be sure to follow the "Precautions for Handling Cord", "Instructions for Maintenance of Cord" and "Other Precautions for Maintenance". Be sure to disconnect the power supply before maintenance of the cord. An old cord may cause breakage, short-circuit, or trouble. We recommend to replace the cord every two years or every 60 times of use, in order to maintain the performance of the reel.

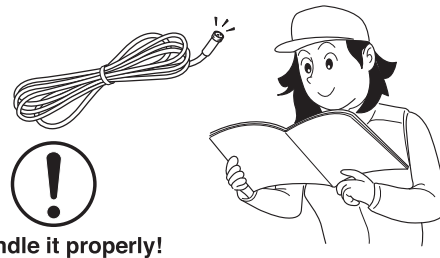

-Do not touch or grab the line when it is being released or wound rapidly. The line may cut your fingers.



-Before reconnecting the power cable on the boat, thoroughly wipe away any moisture such as saltwater from the connecting parts with a dry cloth. If you connect it wet, it may short-circuit causing electric shock, smoke, or even fire.

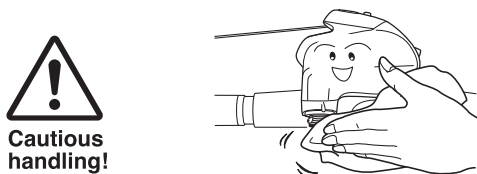

-Do Not touch the heat radiation area of the motor. It may become hot, resulting in getting burned.



# Caution

## ! WARNING

The following pertains to matters that could cause problems or serious, even life-threatening injuries, should the instructions be ignored or incorrectly followed.

-Do Not attempt to disassemble or modify the reel. Failure to do so may cause problems with the performance of the reel or lead to malfunction. Also, this is not covered by the product warranty.



Do not modify!



-Do not modify the cable. It may cause a short-circuit or other problems and could result in smoke or fire.



Do not modify!

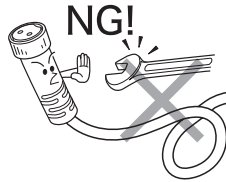

-Stop the operation before disconnecting the power supply. Failure to do so may result in malfunction. Shutting off the power while the reel is rotating may cause sparks, fire or explosion.

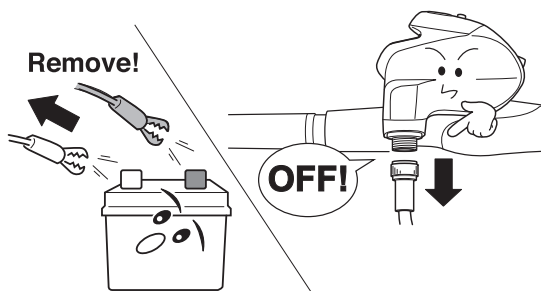

-Before going fishing, please check the reel for proper operation to ensure an enjoyable fishing trip.

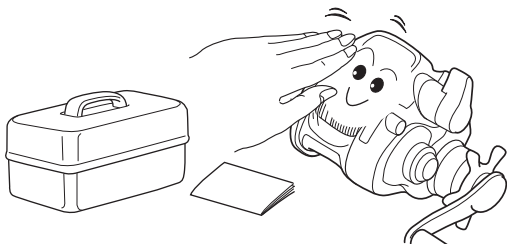

-In the event of abnormalities such as smelling burnt or leakage of electricity, immediately stop the operation and disconnect the power supply. Failure to do so may result in abnormal heat generation, fire, or electric shock.

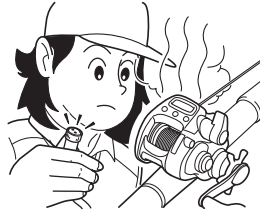

Remove power supply!

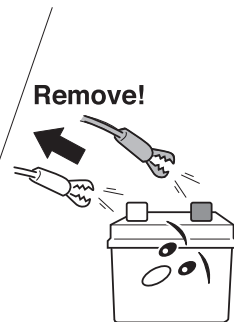

-Shocks, such as dropping the product, may cause breakage or damage to the internal electronic parts, cracks resulting in water intrusion, or short-circuit of the circuit board resulting in functional failure. Be careful not to apply strong shocks or heavy pressure to the product. (Even if there is no abnormality on its appearance, the product may be malfunctioned). Dropping the product also may cause you to be injured.



Cautious handling!

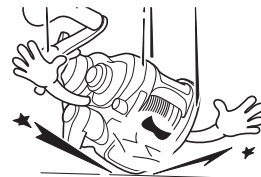

-Be careful not to get a piece of cloth, clothes, hair caught in the reel while winding up the line. Be careful not to wind the loosen line due to backlash, etc.

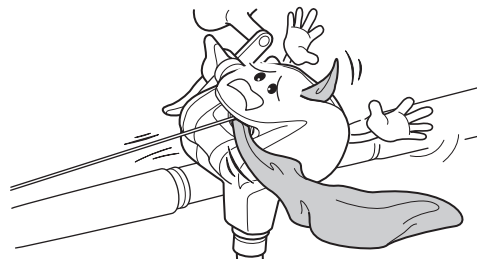

# Caution

## ⚠ CAUTION

The following pertains to matters that could cause problems or serious, even life-threatening injuries, should the instructions be ignored or incorrectly followed.

-If the reel is dropped or shocked, the counter or the main body of the reel may crack resulting in water intrusion. Use of the reel in such a condition may cause the motor to be out of control, resulting in injury. Stop using the product and bring it to your nearest DAIWA dealer for repair.



**Do not use!**



-When winding up line indoors, do so at high speed. If wound up at low speed and high tension, the motor may heat up abnormally and emit smoke. Power to wind up electronically may deteriorate.



**Cautious handling!**



-Do not put a magnetic item such as magnet closer to the product. Otherwise, it malfunctions or causes failure.

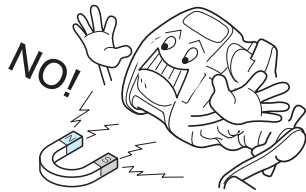

-Do not wind up with excessive force when line is tangled with other angler's lines or snagged on the bottom. It may cause damage to your rod and other components.



**Handle with care!**

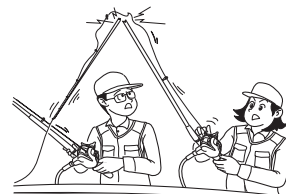

-Handle it cautiously as to not to stain your clothes with grease or oil from moving parts.



**Cautious handling!**



-When your hook is caught in the bottom, do not jerk the rod to free it. Pull the line with your hand and cut it if it fails to pull free. (Be sure to protect your hands with gloves or a towel.) If you use thick leader and cannot cut it with hands, talk to the captain for a safe treatment.



**Risk of injury!**



-Before connecting it to the power supply, be sure to loosen the drag well. If the IC breaks, and the motor does not stop, the terminal rig may be wound into the reel and the rod may break.



**Required handling!**

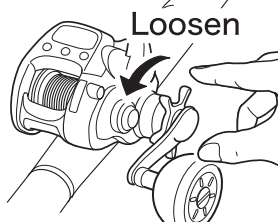

-Do not use wire line with your reel. It may cause corrosion or damage to the spool.



**Do not use!**

**Screech!**

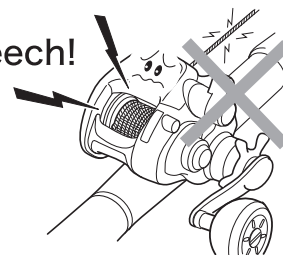



# Caution

## ⚠ CAUTION

The following pertains to matters that could cause problems or serious, even life-threatening injuries, should the instructions be ignored or incorrectly followed.

-Use the reel only for the purpose of fishing.



Never use it for other purpose!

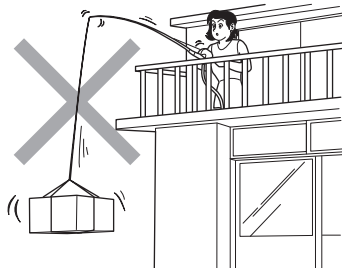

-Reset the counter whenever it displays the wrong number, you have cut off line, disconnected the power supply or changed Line thickness. If you use the reel without resetting the counter, your terminal rig may be pulled into the reel and break the rod or other components. Forgetting to reset it with your terminal rig at the water surface may cause the same problem.



Required operation!

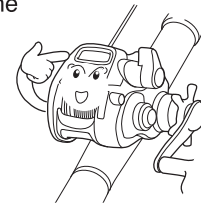

-Do not touch parts where the surface or top coatings (such as paint) are peeled off. It may cause injuries.



Hands off!



-Do not step on or place objects upon the reel. It may cause problems with the reel.

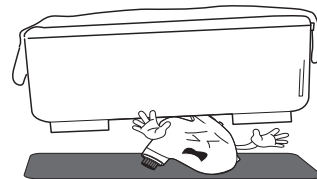

-Do not insert a stick or metallic object into the opening between the spool and the frame or other parts of the reel. It may cause problems with the reel.

NG!

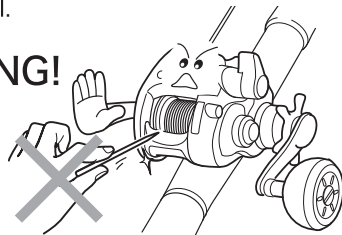

-Do not leave the reel near heating appliances. Resin may melt and deform or deteriorate causing problems.

Hoo

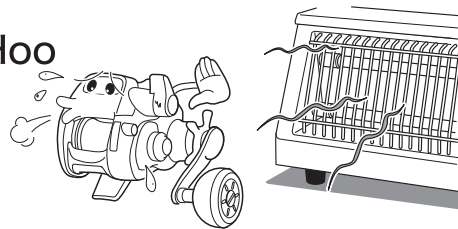

-Do not store a wet reel in a plastic bag or a fishing bag because it may cause rust or malfunction.

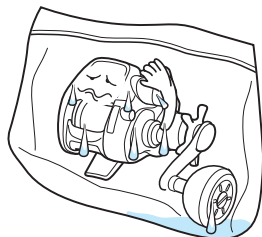

-When storing the reel for a long time, wipe down the moisture completely and preserve it in as well a ventilated place as possible without direct sunlight. Loosen the drag when storing it.

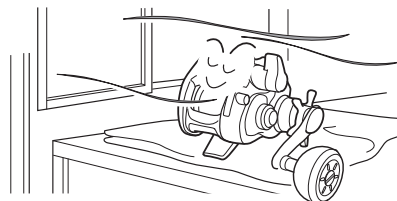

# Caution

## ⚠ CAUTION

The following pertains to matters that could cause problems or serious, even life-threatening injuries, should the instructions be ignored or incorrectly followed.

-Use neutral detergent (dish washing detergent) when washing the electric reel. Do not use chlorine, acidic, or alcohol type cleaners. It may deteriorate resin and cause problems with the reel.



-When the reel is stored with the wet line with salt seawater, the spool may rust. Wash only the spool part with tap water to rinse off seawater sufficiently, and then dry it in a well ventilated place without direct sunlight before storing it.



-Unplug the power supply and the cable when not in use.

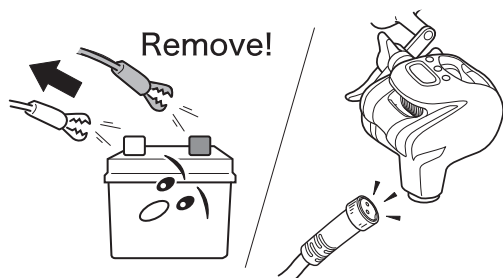

-Do not store the reel with tightly-wound, damp line. During storage, the line may dry up and shrink, resulting in damage to the spool. Do not wind nylon or fluorocarbon line onto a model designated exclusively for PE line (braided line).

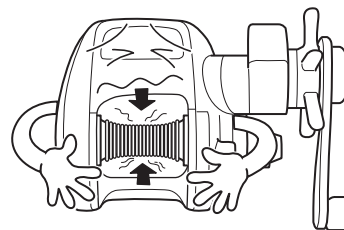

-The position of the pre-set auto-stop point varies depending on the tension of the line being wound. If you change the pre-set auto-stop point, reset the counter to zero at the water surface.

\* Allow enough margin for setting the auto stop point. If you set it without enough margin, your fishing rod may be broken.

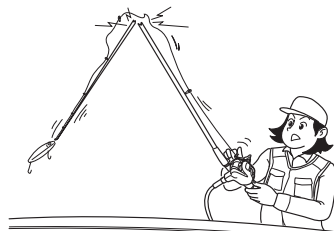

-If the breaker triggers repeatedly, the size of the reel does not match your fishing method or your target fish. Use a reel with the specifications and size that is best for your fishing.

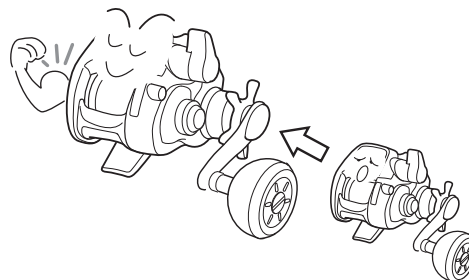

# Caution

## ⚠ CAUTION

The following pertains to matters that could cause problems or serious, even life-threatening injuries, should the instructions be ignored or incorrectly followed.

-When shrinking a telescopic rod, do not tap rod butt on the ground with the reel attached. The reel may be damaged.

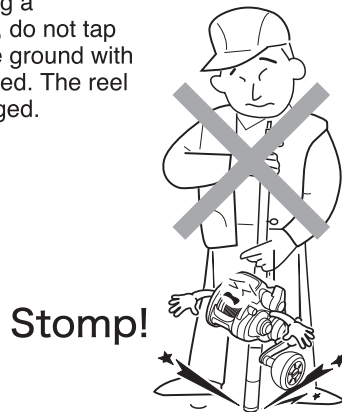

-When fixing the rod into a hole on the boat edge with the reel attached, verify that the reel does not touch the edge. When it touches, do not place it into the hole. The reel may be damaged.

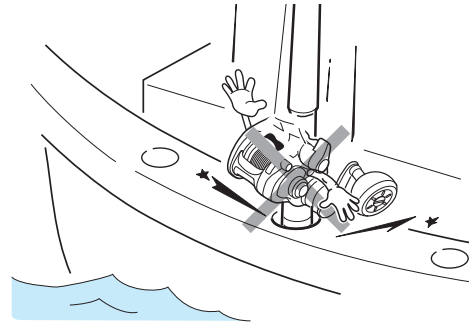

## (MAGSEALED mounted model) INSTRUCTIONS FOR HANDLING

This document contains important instructions regarding special attention that may be required when using an electric reel. Please be sure to read them thoroughly before use.

### ◆ About the counter display

1. Excessively cold or hot weather, mid-winter (display's surface temperature is below  $-10$  degrees centigrade) and mid-summer (display's surface temperature is above  $60$  degrees centigrade).  
\*In the above cases, the characters may be difficult to see due to the characteristics of the liquid crystal. Please note.
2. When light strikes the display from certain angles, the display's digits may have shadows. This does not affect its function.

Registered trademark: This is a product for which DAIWA has obtained a registered trademark. Please be careful of counterfeit and similar products. The manufacture and sale of counterfeit products is punishable by the laws of each country.

# Power source

## How to connect the power source

1. Attach the cord clips to the battery.  
Red covered clip is the plus (+), and the black covered clip is the minus (-).
2. Insert the connector into the reel. After this, the display appears as below.  
By taking the appropriate steps, the indication will change as shown below and the data will be set.

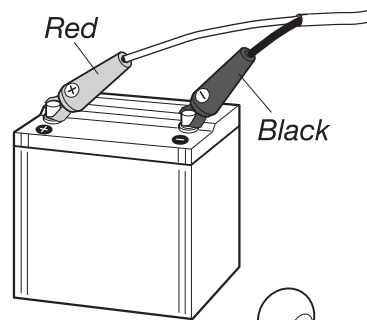

※1



(Screen shown when the unit is turned ON)



(Screen showing the Water Depth)

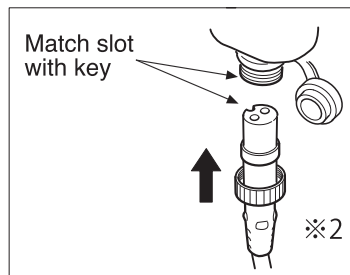

## WARNING

\* 1: Pay attention to the correct polarity. If the power cord is connected in reverse polarity (+/-), it will not conduct electricity and may also cause damage to the battery, the main unit, and the cord.

\* Do not connect the power supply while your hands are wet with freshwater or seawater. Attempting to do so may result in electric shock. If you connect it during rain, wear rubber gloves before connecting it.

\* 2: If it is connected incorrectly, it will not conduct electricity. Incorrect connection may cause short circuit, resulting in the power cord being broken. \* Do not place combustibles or inflammables near the power supply, the reel, or this product. It may cause fire.

## Attention

When changing batteries, the display's back up memory stays active for about 15 minutes after the old battery is disconnected. Thus the above display startup sequence does not need to replay when the new battery is connected within the 15 minute time frame.

# Power source

## About the power source

This reel is designed to be compatible with direct current DC 12 to 16.8 V. You may not use any power sources other than those specified to this reel (for example, AC100V from a household power supply and DC24V equipped on a boat).

The power source voltage on a boat tends to lose stability as it is largely influenced by a generator on board and wiring which may trigger the protective circuit causing sudden stop or intermittent operation of the reel. To maximize the reel performance, be sure to use the electric reel specific batteries.

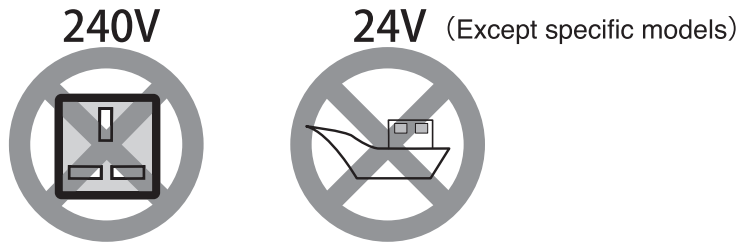

## WARNING

1. We will not warrant any malfunctions or damages caused by the battery.  
\* Daiwa does not recommend to use any batteries of which product standards or safety standard Daiwa is not involved in and are labelled as compatible with Daiwa electric reels. Daiwa will not be liable for any accidents and damages caused by use of these batteries with Daiwa products. If you dare to use them, the use is at your own risk. Particularly, pay attention to the use of lithium batteries, which are likely to cause serious accidents.
2. Use of the power supply of your boat may cause damage to the supply system of the boat.  
\* If you use the power supply of the boat, do not use up all the power capacity while the engine is turned off.  
\* If the power supply is run out, the engine will not start and you will not be able to control your boat.
3. This reel is driven by DC 12V to 16.8V.  
\* Only the model "Marine Power 3000" is driven by 24V. Connecting it to a power supply with a voltage higher than 24 V or connecting to household power supply will damage the electronic circuit of the electric reel, resulting in the motor getting out of control. Incorrect connection may result in smoke or fire. Be sure to check the power supply environment and the specifications.

## Attention

1. Do not use any power supply other than the specified ones.  
As for the power source, we recommend the use of DEEPCYCLE battery which is waterproof secured for marine use.  
Only the specified lithium power supply (in the country where it is sold) can be used for the reel.  
\* Please contact your nearest DAIWA dealer.
2. Connecting the unit directly to a household or marine power source may cause damage.
3. Recharge the battery before your fishing trip. Over time, a battery can naturally discharge.
4. Confirm the boat can provide the proper power source (i.e. voltage, connector shape etc).  
-Corroded connections can prevent the flow of electric current. Remove any corrosion or dirt from the connectors.
5. Use a battery of the correct voltage output. Winding up with a high load while the voltage is low may damage electronic components.

# Power source

## Battery level indicator

When the battery voltage is lowered while powered ON, the battery level indicator becomes as shown below.

When the voltage goes down to 10V or less, the winding power of the reel is restricted and the maximum performance cannot be gained.

If this indicator is blinking while the motor is not running, battery voltage may be low due to decreasing of the residual capacity of the battery. If it is blinking, replace the battery with a recharged one (If you use the on-board power supply, check the voltage and the terminal of your boat).

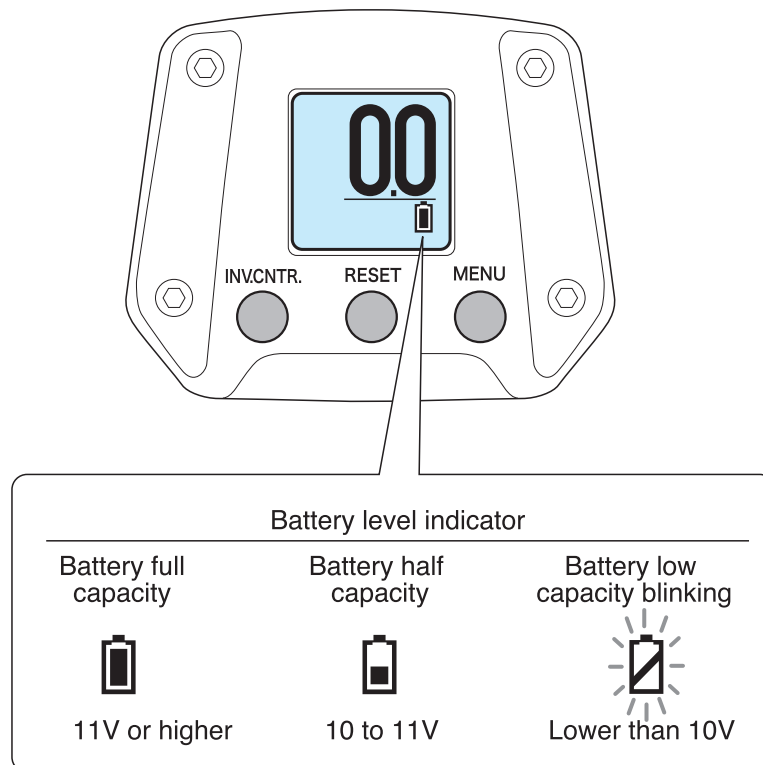

\*There may be a slight difference between the reel detection voltage and the actual voltage of the power supply.

\*When the battery runs out and the counter display goes out, be sure not to operate your electric reel manually to wind the line and be sure to replace the battery with a recharged one before doing any operations (relating to fishing). Any manual operation in such condition may cause the water depth counter to go out of order, resulting in the tip of fishing rod being broken due to accidentally winding up all the line when you restart an electrical winding later with a replaced battery.

### Attention

-When a low battery indication appears, replace the battery with a fully charged one, as operation with low battery may cause problems with electric winding and or IC functions, etc.

# Maintenance

## About maintenance

This is a washable reel. Wash away salt residue and grit after fishing.

## Maintenance procedure

1. Wash the reel with a dish washing detergent and a soft sponge. Do not use solvents.

\*Do not use soap or other detergents. Other soaps or solutions may damage the reel both externally and internally.

\*Recommended quantity: 1.5 ml per liter of water. The solution may damage the outside coating of the reel and may breakdown the grease inside of the reel creating an overflow of grease.

2. Rinse detergent and dirt away with running water, rinsing the spool very well to get rid of salt. Use warm water, under 30 degrees centigrade.

3. Dry the reel well.

\*Loosen the drag when stored.

\*Be sure to remove water from inside the handle knob, because water could stay there.

4. Feed oil.

Spray oil on the worm shaft.

Get the specific spray from a fishing-tackle store.

\*Do not lubricate any portion around the LCD display. It may cause malfunction of electronic components.

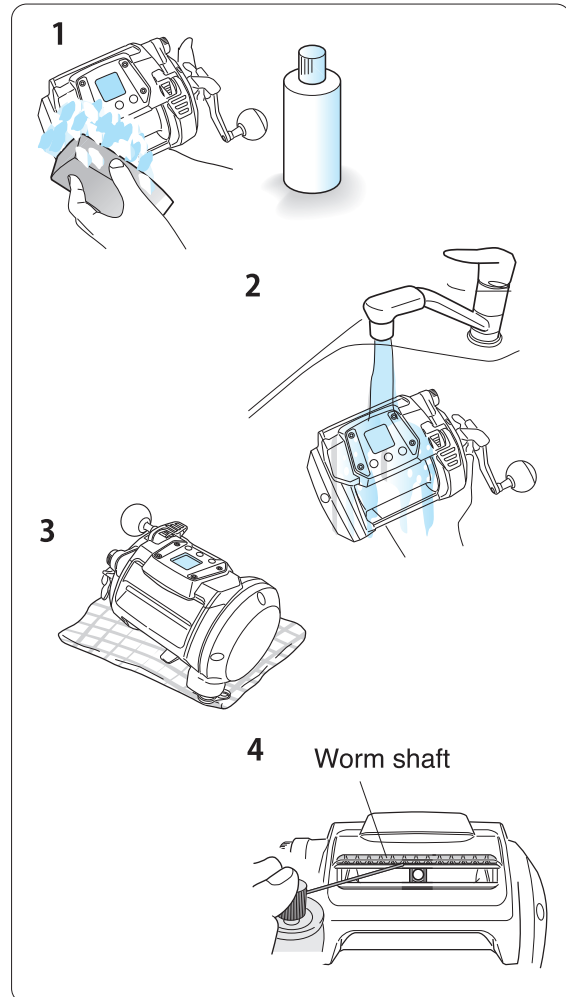

## Attention

1. Do not wash with seawater or soak in water.
2. Do not use organic solvents such as benzene and thinner.
3. Do not use a steel brush or abrasive cleanser.
4. The fed oil may spring back and squirt. Do not peer down the worm shaft part.
5. Do not feed oil to water discharge hole.
6. Do not put magnetic force closer to the product main body.

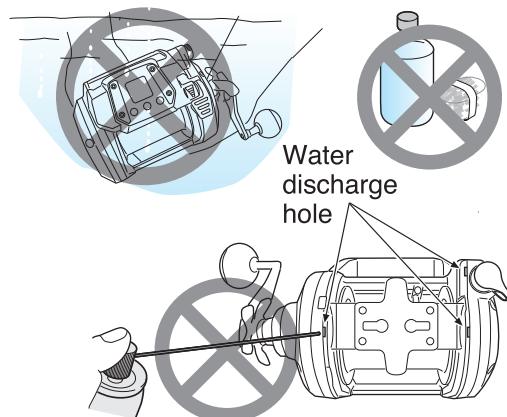

# Maintenance

## Handling and maintenance of the power cord

Follow the restrictions below to avoid troubles caused by disconnection of power cord and the like. Be sure to use the specific power cord supplied with the reel unit.

\*Note that the unit is not compatible with any other power cord.

\*Do not modify the power cord. It may cause an unintended failure. Be sure to keep the power cord intact.

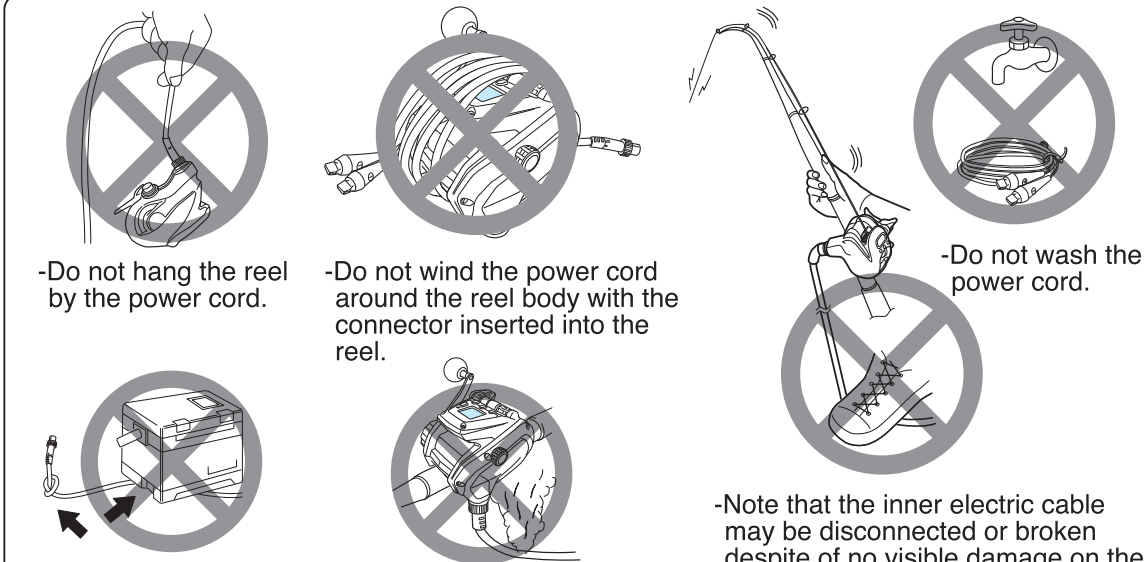

- Do not hang the reel by the power cord.
- Do not wind the power cord around the reel body with the connector inserted into the reel.
- Do not wash the power cord.
- Do not set heavy items on the power cord, or tie knots in the power cord.
- If any abnormal events occur, including smoke and abnormal odor, stop the use of the power cord and remove it immediately from the battery.
- Note that the inner electric cable may be disconnected or broken despite of no visible damage on the appearance, if you step on the power cord, or if you pull the power cord strongly when it is trapped with cargoes, during use.

## Maintenance of the power cord

- Wipe the power cord with a wet cloth and dry it well.
- Pay special attention to drying the tips, with cover removed.
- Grease the connector after it is dried.
- \*The dedicated grease is available at fishing tackle shops.
- Disconnect the power cord from the reel before storing.

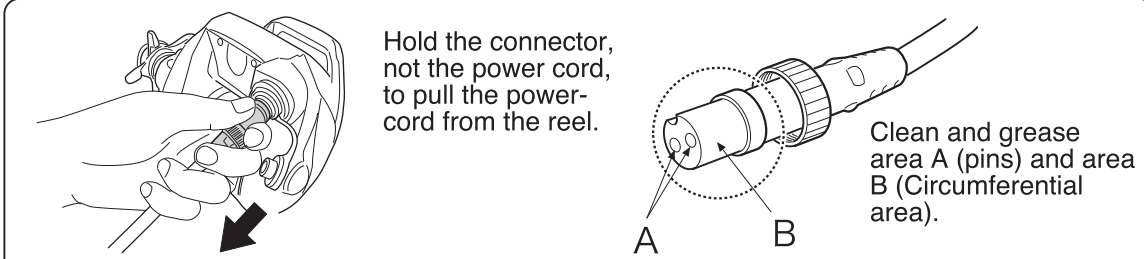

Hold the connector, not the power cord, to pull the power cord from the reel.

Clean and grease area A (pins) and area B (Circumferential area).

## Other maintenance points

- This reel is a precision instrument that employs electric circuitry and motor. Do not disassemble the reel by yourself.
- Cover the power connector on the reel with its protection cap.
- An old cord may cause breakage, short-circuit, or trouble. We recommend to replace the cord every two years or every 60 times of use, in order to maintain the performance of the reel.



# Names and functions of each part

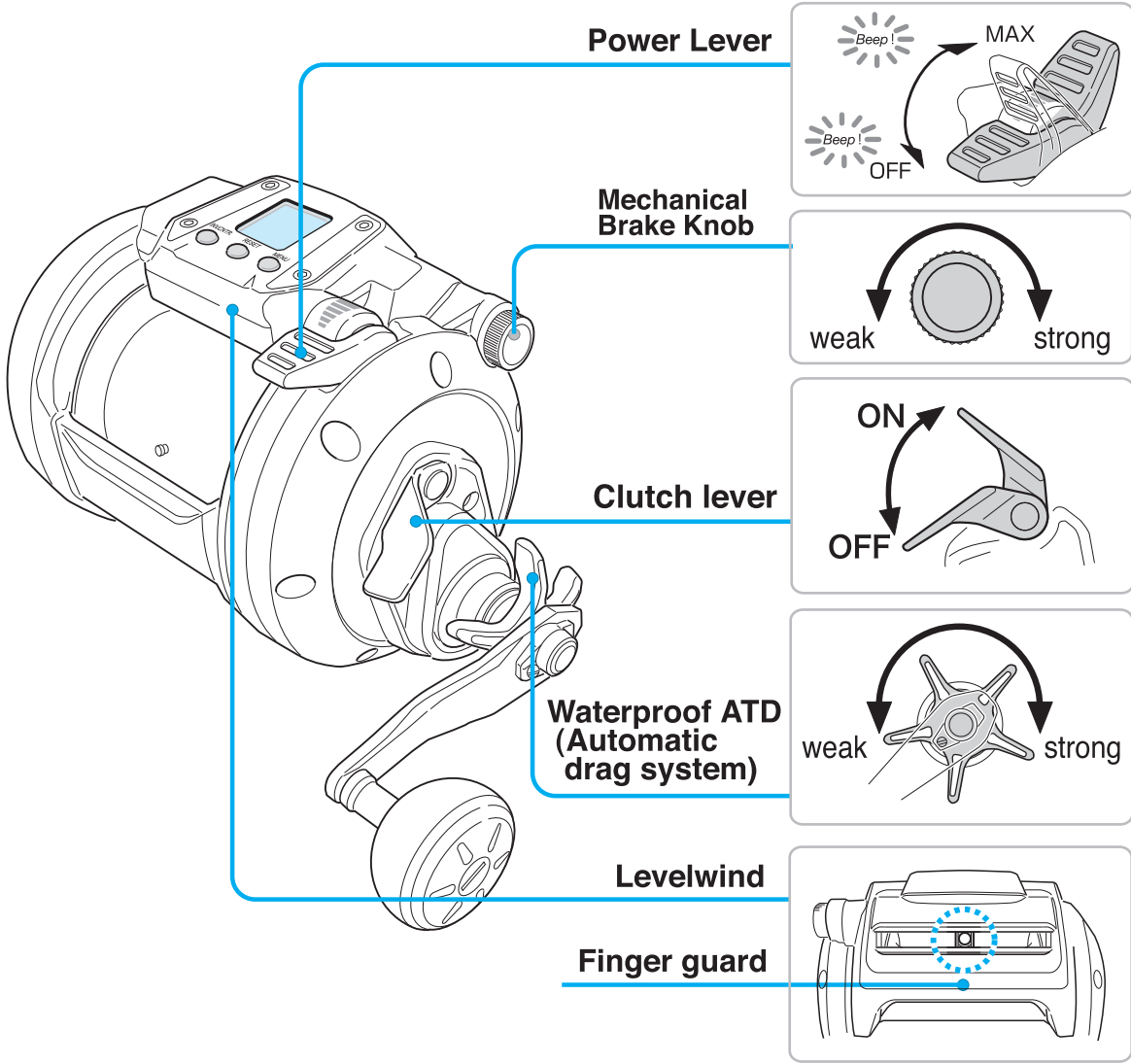

## Accessories

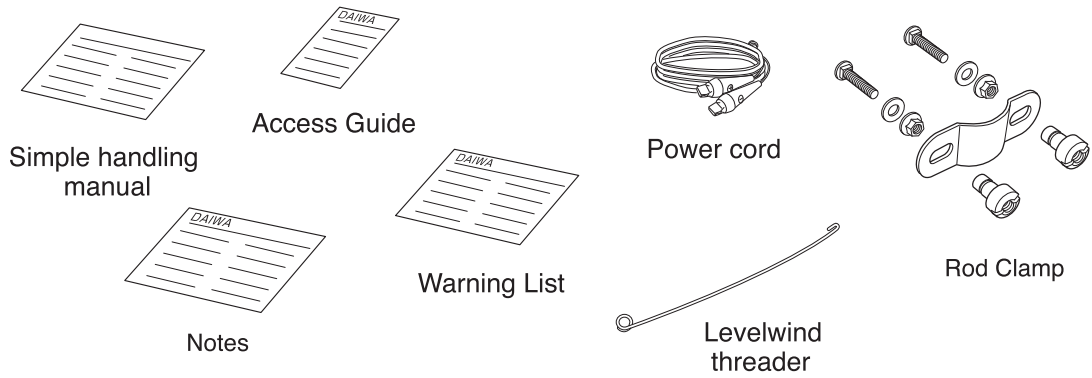

# Names and functions of each part

## Jog Power Lever

-You can operate the lever by pinching it with your thumb and forefinger.

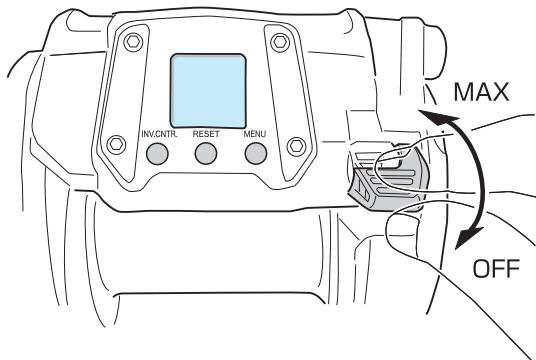

- You can freely adjust the winding power or the winding speed from OFF to MAX by using the lever.
- Turning the lever forward (toward MAX) will increase the winding power. Tuning the lever back (toward OFF) will decrease the power.
- Check the position of the lever before you start winding. If it is not at OFF position, turn it back to OFF position (an audible alarm will sound to tell you that the lever has backed to the OFF position). Then, push the lever forward to start winding.
- Note that the lever does not accept your lever manipulation near the pre-set auto stop point for safety reasons.
- The displayed value for setting by the lever may fluctuate due to winding load fluctuation but it is not abnormal event.

## Waterproof ATD (Automatic Drag System) \*With a drag knob click system

- This is designed to provide a mechanism whereby adjusting the star drag allows the spool to slip against a strong pull to avoid line breakage.
1. Set the reel on the rod and put the line through the rod guide before adjusting the drag.
  2. Adjust the tightness of the drag, with the clutch ON, manually pulling the line out from the reel. Normally, adjust the drag allowing the spool to slip before the line breakage (trace line).

## Clutch Lever

-The clutch turns to ON by pressing the lever when the clutch is OFF.

## Mechanical Brake Knob

-This allows you to adjust the rig dropping speed to prevent from backlash. Please adjust the tightness depending on the conditions such as rolling of your boat and the rig weight.

## Levelwind

-The levelwind allows to ensure an even winding of the line on the spool that is passed through the guide.  
\*The line may be wound unevenly on the spool depending on the winding condition in some cases.

## Accessories

- Power cord
- Rod Clamp
- Notes
- Warning List
- Access Guide
- Simple handling manual
- Levelwind threader  
It is used to put the line through the level wind.

# Names of the buttons and the display

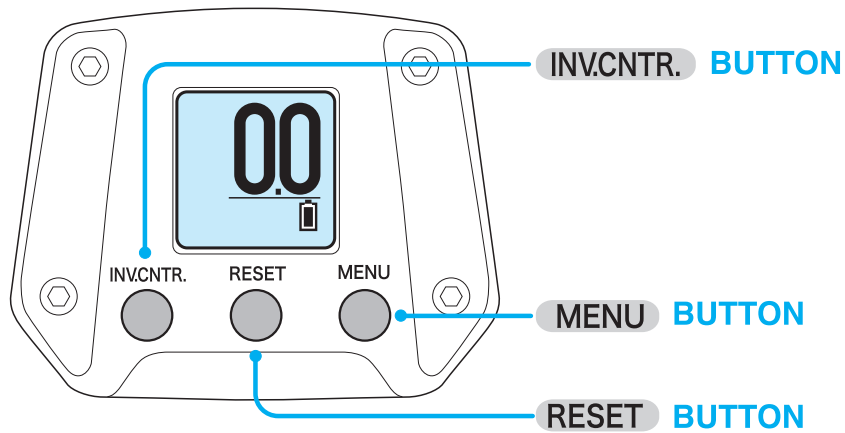

## ● RESET

- Press the **RESET BUTTON** once always before you start fishing.
- The auto stop position is set based on the point where you pressed the **RESET BUTTON**.
- Pressing and holding this button for 2 seconds or more allows you to correct the data when the line has broken.

## ● MENU

- This allows you to set various useful functions.

## ● INVCNTR.

- This button is used to reset the Inverse Counter.
- Pressing and holding this button allows you to set the Auto Stop point.
- This works as **EXIT BUTTON** in the menu.

# Preparation

Connection to the power source and selection of language.

1. Energize your reel.

\*For the details of the connection procedure, refer to the page 10 “How to connect the power source”.

2. Select your desired language with the Power Lever and press **OK** ( **MENU** **BUTTON** ).

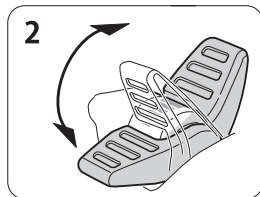

3. Check that your selected language is correct and press **OK** ( **MENU** **BUTTON** ).

4. Select your desired unit with the Power Lever and press **OK** ( **MENU** **BUTTON** ).

\*Only if you have selected “English”

5. Setting is completed when you move to the “Water Depth” screen.

**Attention:**

You can change your preset language and unit anytime you want from the MENU screen.

\*For the details, refer to the page P37 “LANGUAGE setting”.

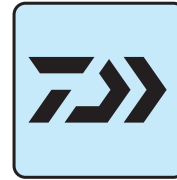

(Screen shown when the unit is turned ON)

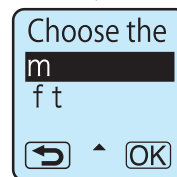
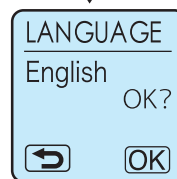
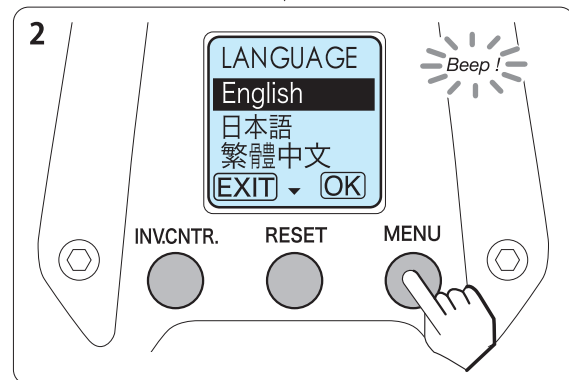

# Functional setting [1. How to operate the Menu screen]

## Setting of useful functions

-The Menu provides various useful functions for your fishing.  
 \*Once you have set up a parameter, it is saved in the memory for your next fishing.  
 (Settings may not be saved in the memory if you turn off the power immediately after setting)

1. When **0.0** is displayed, press and hold **MENU** **BUTTON**.

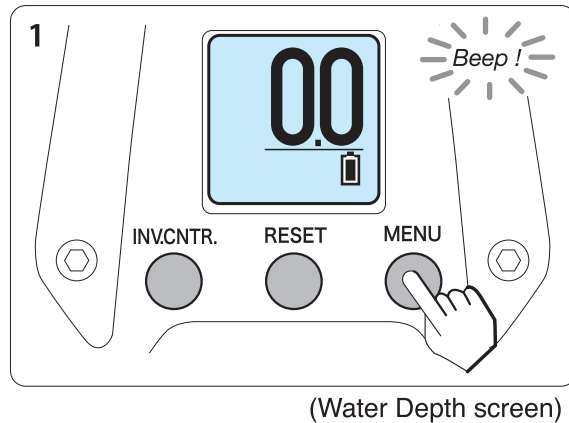

2. Select a parameter using the Power Lever and press **OK** (**MENU** **BUTTON**) to go the screen for setting.

\*The Power Lever display shown right will be lit if you do not operate for some seconds.  
 \*For details on setting of each parameter, refer to the following pages.

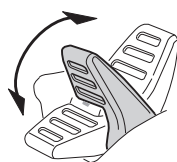
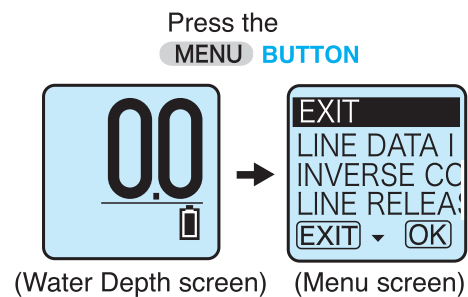

You can select your desired parameter using the Power Lever.

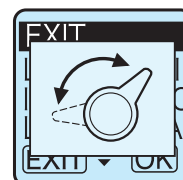

EXIT	
LINE DATA INPUT	→ See P21 - 30
INVERSE COUNTER	→ See P33
LINE RELEASE ASST	→ See P34
ALARM	→ See P37
HISTORY	→ See P36
LANGUAGE(言語)	→ See P18,37
UNIT	→ See P38
EXIT ▾ OK	

# Functional setting [1. How to operate the Menu screen]

## ■ Operation in the Menu screen



Here, the Menu screen is used as an example to how to operate the screen.

**OK** **BUTTON**

Pressing **MENU** **BUTTON** allows you to go to the next screen.

If ▲ or ▼ is displayed, you can select any parameter by scrolling the screen with the Power Lever.

**EXIT (RETURN)** **BUTTON**

Pressing and holding the **INVCNTR.** **BUTTON** allows you to return to the Water Depth screen.

Alternatively, selecting “Return to Water Depth” in the counter menu and pressing **OK** (**MENU** **BUTTON**) allows you to return to the Water Depth screen.

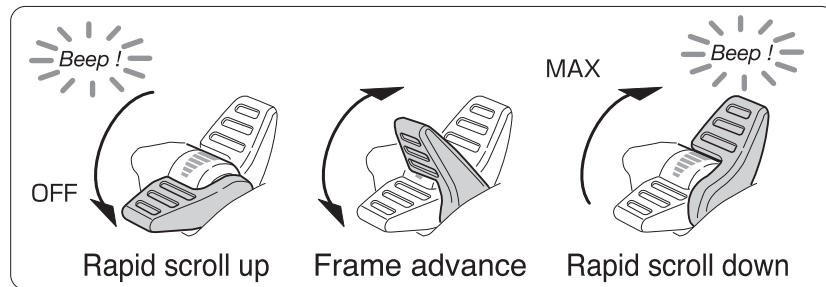

3. Once the settings have been completed, return to the Water Depth screen to start fishing.

# Functional setting [2. LINE DATA INPUT]

This function is convenient when you know the length of the fishing line to be wound on the reel.

## P1 When line length is known

(The following example explains how to insert a J-BRAID 80lb-1000m fishing line.)



### Watch out for Burns!

An overly heated motor may cause the frame and the spool to become very hot, so do not touch it directly when inserting the main line. Insert the line while holding the frame with a wet towel, etc.

1. Pass the main line through the Level Wind and tie it to the spool.

- \*The enclosed threading pin facilitates the process.
- \*Make sure to tie the line to the line stopper to prevent the line from slipping on the spool.
- \*Tighten the drag.

2. Return the Power Lever to OFF.

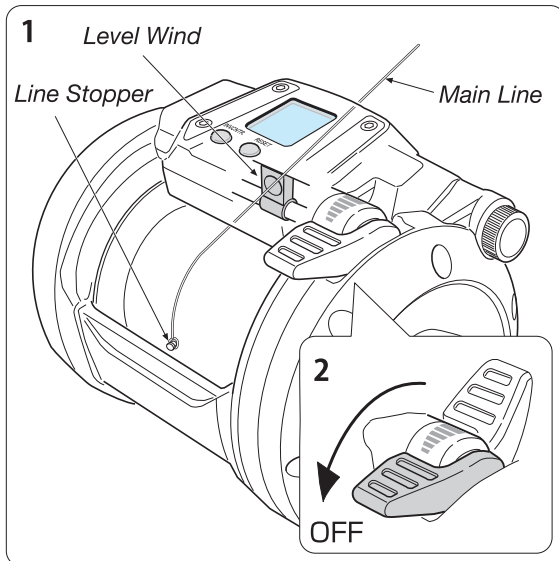

3. Turn on the reel.

- \*Please refer to the page 10 "How to connect the power source" for the details of the connection method.



(Screen shown when the unit is turned ON)

4. When **0.0** is displayed, press

**MENU** **BUTTON**.

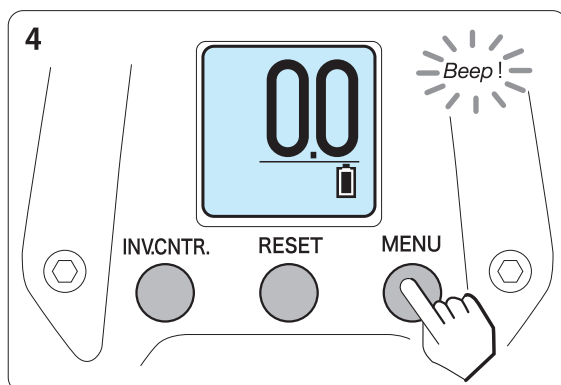

(Water Depth Screen)

# Functional setting [2. LINE DATA INPUT]

## P1 When line length is known

5. Select "LINE DATA INPUT" with the Power Lever and press **OK** ( **MENU** **BUTTON** ).

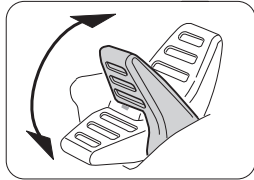

\*By moving the Power Lever, the selected item is highlighted on the screen.

\*When "LINE DATA INPUT" is chosen, 《Start》 is displayed, press **OK** ( **MENU** **BUTTON** ) one more time.

6. Select "P1 when line length is known" and then press **OK** ( **MENU** **BUTTON** ).

7. After adjusting the tension, turn the Power Lever to the MAX position and then wind the main line.

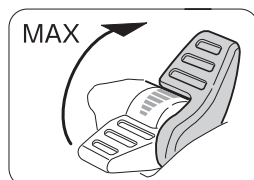

\*While winding up the line, try to adjust the tension so that the mark ▼ stays around the screen center.

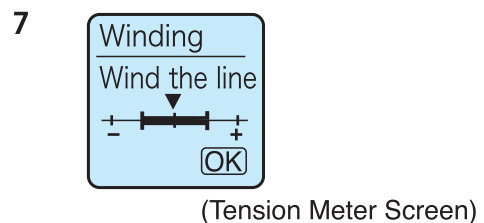
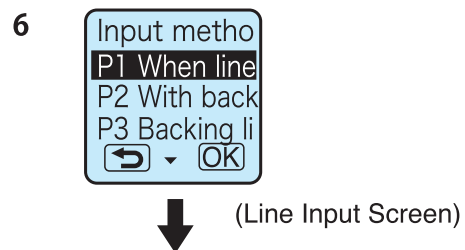
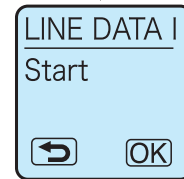

### Attention

- The reel may be damaged if the line touches the finger-guard or the frame. Keep the line from touching these components.
- Winding the line indoors for a prolonged period at a low speed with an elevated tension may cause the motor to overheat and thus fail. Please input by turning the Power Lever to the MAX position. While actual fishing in outdoors, there is no need to worry about overheat problem because motor is cooled down by seawater, etc.



# Functional setting [2. LINE DATA INPUT]

## P1 When line length is known

8. When winding is complete, turn the Jog Power Lever back to the OFF position and then press **OK** ( **MENU BUTTON** ).

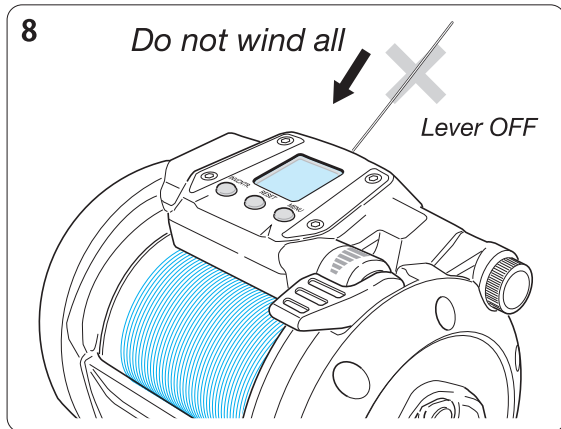
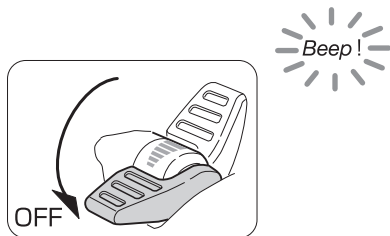

### Attention

- Do not wind all the line. Before winding up all of the line, turn the Power Level to the OFF position and then wind up the remaining line manually with the handle. Winding up all may cause an error with the counter.
- This winding method cannot be applied to lines thinner than J-BRAID 65lb.
- When winding a J-BRAID 65lb or thinner line, the line may enter the gap between the spool and the frame if wound close to the spool's outer diameter; so it is advisable to wind the line up to about 1mm inside the outer edge of the spool.

9. Select the line length with the Power Lever and then press **OK** ( **MENU BUTTON** ).

\*The illustration shows a case of inserting 1000m.  
 \*The default value is set at 500m.  
 \*The value can be set for every 10m.

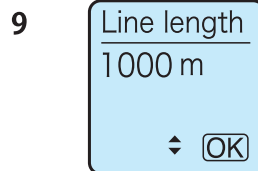
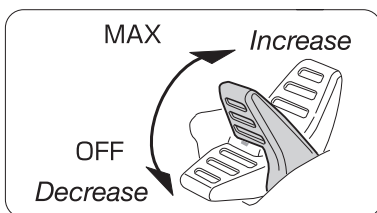

10. When "Complete" is displayed on the screen, press **OK** ( **MENU BUTTON** ) and the display will return to the water depth screen to complete inserting the line.

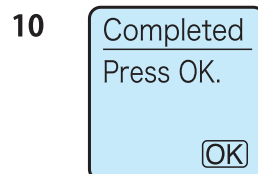

\*When "Error" is displayed while inserting the line, press **OK** ( **MENU BUTTON** ) to return to the MENU screen and re-start the process from the beginning.

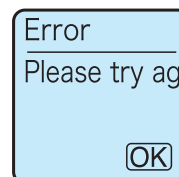

# Functional setting [2. LINE DATA INPUT]

## P2 With backing line

Note that a 100 m or longer line of which length is known is necessary.



### Watch out for Burns!

An overly heated motor may cause the frame and the spool to become very hot, so do not touch it directly when inserting the main line. Insert the line while holding the frame with a wet towel, etc.

1. Pass the main line through the Level Wind and tie it to the spool.

\*The enclosed threading pin (See P12) facilitates the process.

\*Make sure to tie the line to the line stopper to prevent the line from slipping on the spool.

\*Tighten the drag.

\*If you have already completed winding of the backing line, skip this step and go to the next step.

2. Return the Power Lever to OFF.

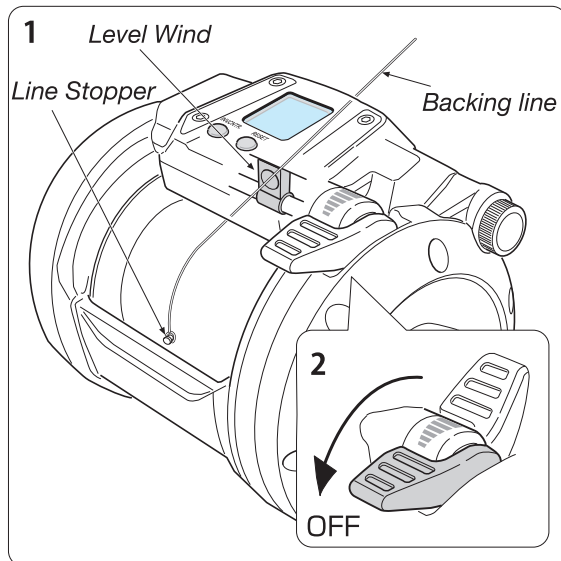

3. Turn on the reel.

\*Please refer to the page 10 “How to connect power source” for the details of the connection method.

3



(Screen shown when the unit is turned ON)

4. When 0.0 is displayed, press

**MENU** **BUTTON**.

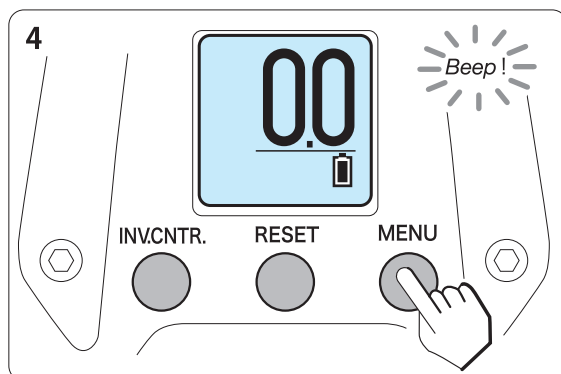

(Water Depth Screen)



# Functional setting [2. LINE DATA INPUT]

5. Select "LINE DATA INPUT" with the Jog Power Lever and press **OK** ( **MENU** **BUTTON** ).

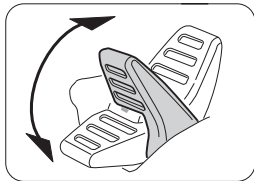

\*By moving the Power Lever, the selected item is highlighted on the screen.

\*When "LINE DATA INPUT" is chosen, 《Start》 is displayed, press **OK** ( **MENU** **BUTTON** ) one more time.

6. Select "P2 with backing line" and then press **OK** ( **MENU** **BUTTON** ).

7. Wind up the backing line. If winding of the backing line is completed, press **OK** ( **MENU** **BUTTON** ).

\* If you have already completed winding of the backing line, skip this step and go to the next step by pressing **OK** ( **MENU** **BUTTON** ).

8. Firmly tie the main line to the backing line.

9. After adjusting the tension, turn the Power Lever to the MAX position. and wind the main line up until the remaining line is 100 m, as checking the line color.

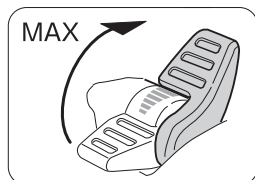

\*While winding up the line, try to adjust the tension so that the mark ▼ stays around the screen center.

## P2 With backing line

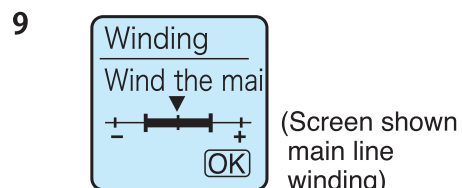
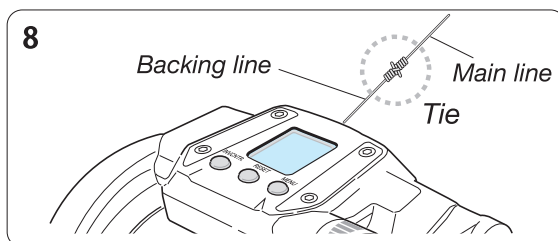
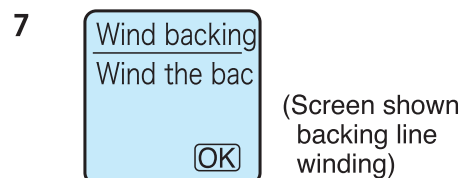
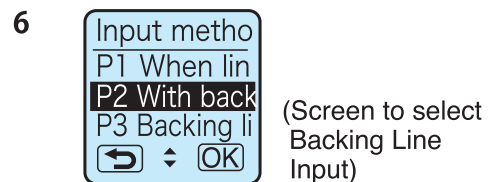
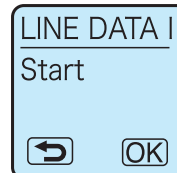
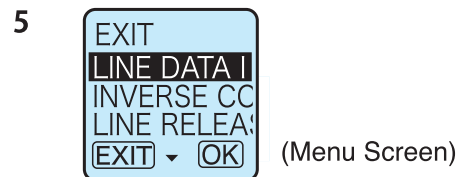

# Functional setting [2. LINE DATA INPUT]

## P2 With backing line

### Attention

-The reel may be damaged if the line touches the finger-guard or the frame. Keep the line from touching these components.  
 -Winding the line indoors for a prolonged period at a low speed with an elevated tension may cause the motor to overheat and thus fail. Please input by turning the Power Lever to the MAX position. While actual fishing in outdoors, there is no need to worry about overheat problem because motor is cooled down by seawater, etc.

10. When winding is completed, turn the Power Lever back to the OFF position and then press **OK** ( **MENU** **BUTTON** ).

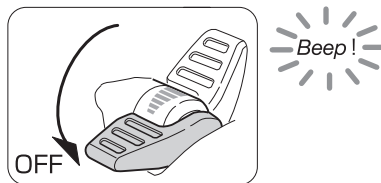

11. After adjusting the tension, turn the Power Lever to the MAX position. Wind on another 50 m of line as checking the line color.

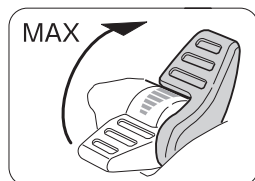

11

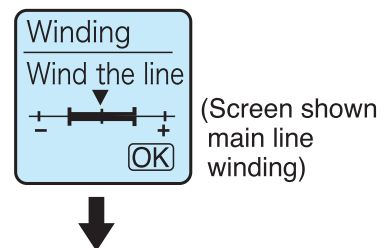

\*While winding up the line, try to adjust the tension so that the mark ▼ stays around the screen center.

12. When winding is completed, turn the Power Lever back to the OFF position and then press **OK** ( **MENU** **BUTTON** ).

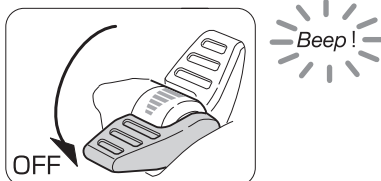

13

13. After adjusting the tension, turn the Power Lever to the MAX position and wind the main line up to its end as checking the line color.

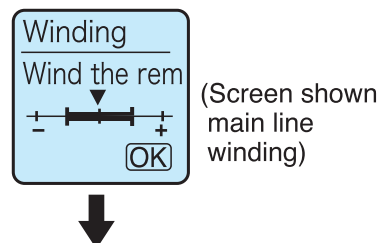
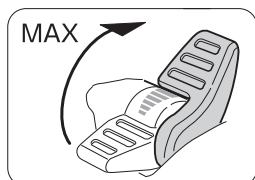

\*While winding up the line, try to adjust the tension so that the mark ▼ stays around the screen center.

# Functional setting [2. LINE DATA INPUT]

## P2 With backing line

### Attention

- Do not wind all the line. Before winding up all of the line, turn the Power Level to the OFF position and then wind up the remaining line manually with the handle. Winding up all may cause an error with the counter.
- This winding method cannot be applied to lines thinner than J-BRAID 65lb.
- When winding a J-BRAID 65lb or thinner line, the line may enter the gap between the spool and the frame if wound close to the spool's outer diameter; so it is advisable to wind the line up to about 1mm inside the outer edge of the spool.

14. When winding is completed, turn the Power Lever back to the OFF position and then press **OK** ( **MENU** **BUTTON** ).

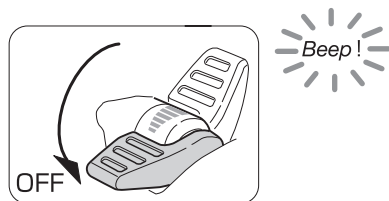

15. When "Completed" is displayed on the screen, press **OK** ( **MENU** **BUTTON** ) to return to the Water Depth screen and complete the data input of the line.

15

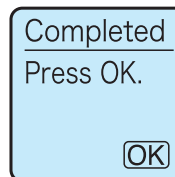

- \* If "Error" appears on the screen while inputting the line data, press **OK** ( **MENU** **BUTTON** ) to return to the MENU screen and re-start the process from the beginning.



# Functional setting [2. LINE DATA INPUT]

## P3 Backing line 2

This option allows you to re-enter the line data, pulling out the line after it has been completely wound up onto the reel.

Note that it is necessary that you know the line length and that it is greater than 100 m.

1. Pass the main line through the Level Wind and tie it to the spool.

\*The enclosed threading pin facilitates the process.

\*Make sure to tie the line to the line stopper to prevent the line from slipping on the spool.

\*Tighten the drag.

2. Return the Power Lever to OFF.

3. Turn on the reel.

\*Please refer to the page 10 “How to connect power source” for the details of the connection method.

4. When **0.0** is displayed, press

**MENU** **BUTTON** .

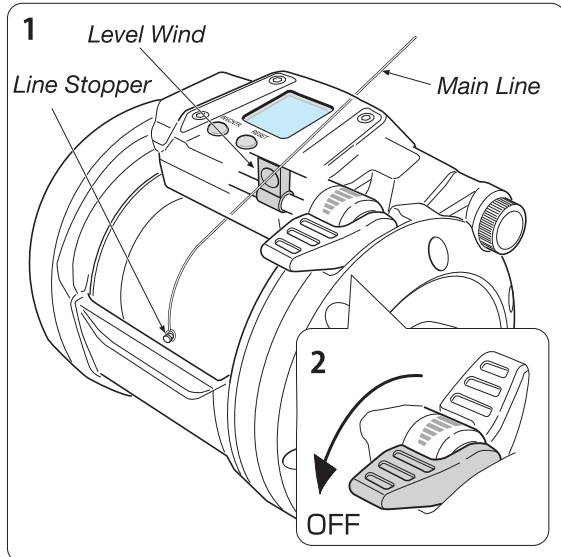

3



(Screen shown when the unit is turned ON)

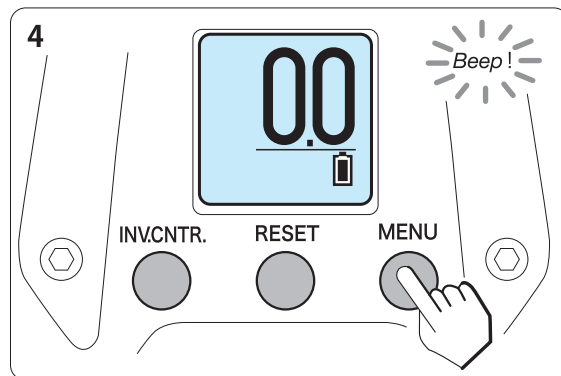

(Water Depth Screen)



# Functional setting [2. LINE DATA INPUT]

5. Select "LINE DATA INPUT" with the Power Lever and press **OK** ( **MENU** **BUTTON** ).

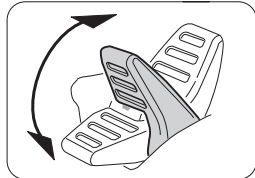

\*By moving the Power Lever, the selected item is highlighted on the screen.

\*When "LINE DATA INPUT" is chosen, «Start» is displayed, press **OK** ( **MENU** **BUTTON** ) one more time.

6. Select "P3 Backing line 2" and then press **OK** ( **MENU** **BUTTON** ).

\*The screen automatically switches to "Speed Range"

7. After adjusting the tension, turn the Power Lever to the MAX position and then wind the main line.

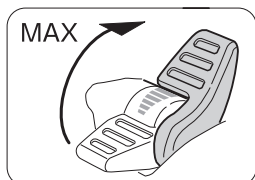

\*While winding up the line, try to adjust the tension so that the mark ▼ stays around the screen center.

\*When you have already completed winding the main line, simply press **OK** ( **MENU** **BUTTON** ).

## P3 Backing line 2

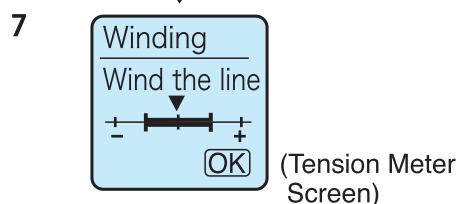
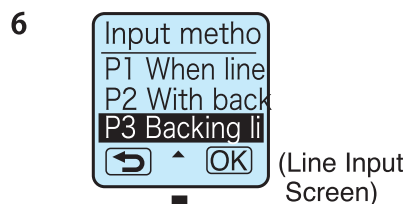
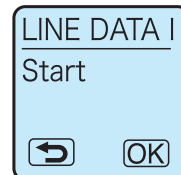
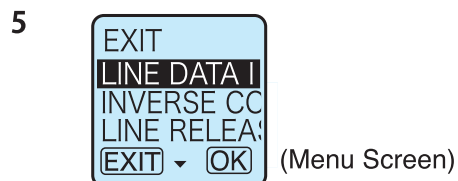

### Attention

- The reel may be damaged if the line touches the finger-guard or the frame. Keep the line from touching these components.
- Winding the line indoors for a prolonged period at a low speed with an elevated tension may cause the motor to overheat and thus fail. Please input by turning the Jog Power Lever to the MAX position. While actual fishing in outdoors, there is no need to worry about overheat problem because motor is cooled down by seawater, etc.

# Functional setting [2. LINE DATA INPUT]

## P3 Backing line 2

8. When winding is completed, turn the Power Lever back to the OFF position and then press **OK** ( **MENU** **BUTTON** ).

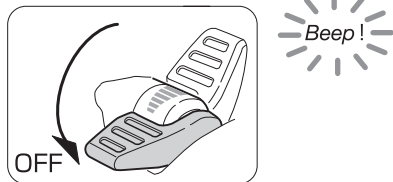

9. Pull 50 m of the line out of the reel as checking the line color and press **OK** ( **MENU** **BUTTON** ).

10. Pull another 50 m of the line out of the reel as checking the line color and press **OK** ( **MENU** **BUTTON** ).

11. When "Completed" is displayed on the screen, press **OK** ( **MENU** **BUTTON** ) to return to the Water Depth screen. Wind up the line that you pulled out from the reel. If you wound it up, the procedure is completed.

\*If "Error" appears on the screen while inputting the line data, press **OK** ( **MENU** **BUTTON** ) to return to the MENU screen and re-start the process from the beginning.

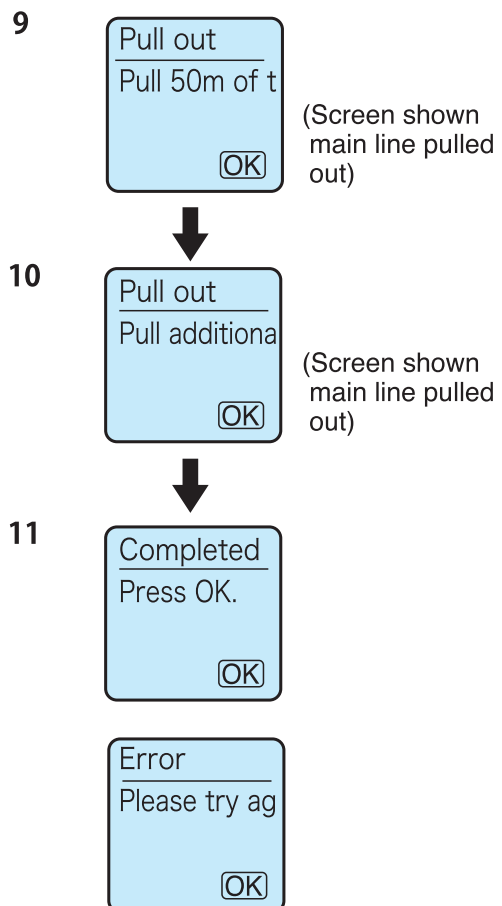

### Attention

- Do not wind all the line. Before winding up all of the line, turn the Power Level to the OFF position and then wind up the remaining line manually with the handle. Winding up all may cause an error with the counter.
- This winding method cannot be applied to lines thinner than J-BRAID 80lb.
- When winding a J-BRAID 65lb or thinner line, the line may enter the gap between the spool and the frame if wound close to the spool's outer diameter; so it is advisable to wind the line up to about 1mm inside the outer edge of the spool.



# Functional setting [3. Before start fishing]

## Water surface zero setting

Before you start fishing, always perform this zero setting to identify a more accurate depth of the strike zone for fishing.

1. Connect the reel to the battery. Pass the line through all the guides, and prepare your terminal rig.

2. Lower the terminal rig to the water surface and press the **RESET BUTTON**.

Setting is completed when **0.0** is displayed with a beep sound.

While electrical winding up is in action, winding will automatically stop at 2 m before auto stop at the boat side.

\*If this “Water surface zero setting” is not made, winding will automatically stop at 5 m before the auto stop point for safety.

\*After auto stop at the boat side, the Power Lever will be disabled to wind up the line to prevent the rig from being accidentally wound up due to miss operation.

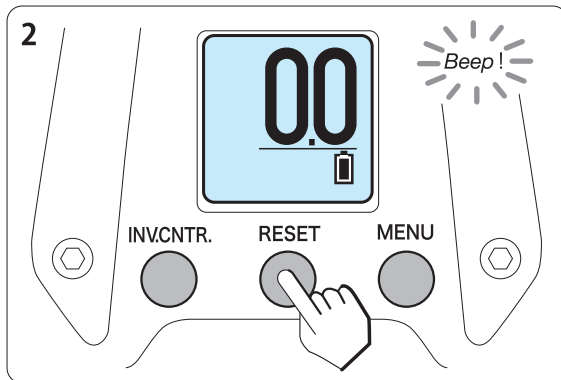
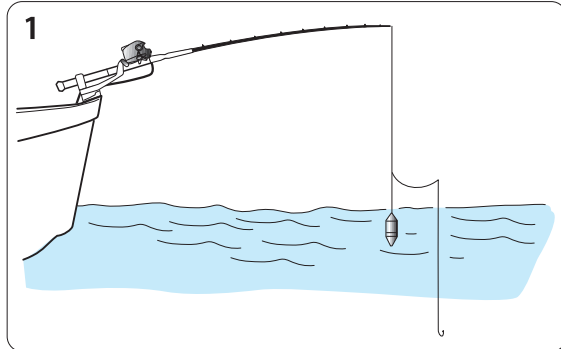

### Attention

- When new line is wound up, or when line has been pulled under heavy tension, line stretch may cause a gap in the auto stop point at the boat side. Simply reset the surface setting to set it to zero.
- Depending upon the rolling of the boat or sinker weight, auto stop point can overrun slightly. Should this happen, increase the depth of the auto stop.
- Fishing at a depth over 328 ft (100 m) with a load largely fluctuating may cause a gap in the stop point. Thus, the terminal rig may be accidentally wound up and the rod may be broken. In such fishing, it is recommended to have sufficient margin in setting of auto stop point to avoid such events.

## If the main line is broken

-Should your line break, revise data as follows.

Revise the data of the broken line. Wind the line to the rod tip while the reel is powered on. Then, press the **RESET BUTTON** for 2 seconds or more. When the display shows **0.0**, then your re-adjustment is completed.

\*The line data will be overwritten (revised) by the procedure described above.

\*Do not press and hold the **RESET BUTTON**, except for data correction of a broken line; it may cause an error in the counter.

# Functional setting [4. Auto stop]

## Adjustable auto stop setting

The auto stop point can be set to meet your own specific needs and ease your preparatory works such as checking and changing of baits and sinkers.

-You can set the auto stop point by setting the adjustable depth within the range 1 to 5 m from the point where you press **INVCNTR. BUTTON** (in 10 cm increments).

Note that it is designed not to allow you to set the auto stop point to any value below 1 m for safety reasons.

-In the case when you feel the auto stop point comes down due to line stretch, simply reset the counter to zero at the water surface.

-Note that the Power Lever may not be allowed to manipulate around the auto stop point for safety reasons.

1. While the reel is powered on and your terminal rig is on the water surface, press the **RESET BUTTON** (water surface zero setting).

The display will show **0.0**.

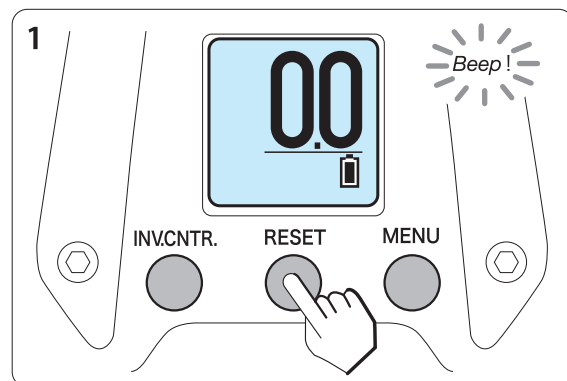

2. Raise your rod tip and pull the line out adjusting the line length from the rod tip so that you can reach the rig easily.

In the figure, its length is 1.5 m.

### Use

*For your quicker drop and retrieve actions, it is recommended to set the auto stop point so that you can easily reach the rig when you raise your rod tip.*

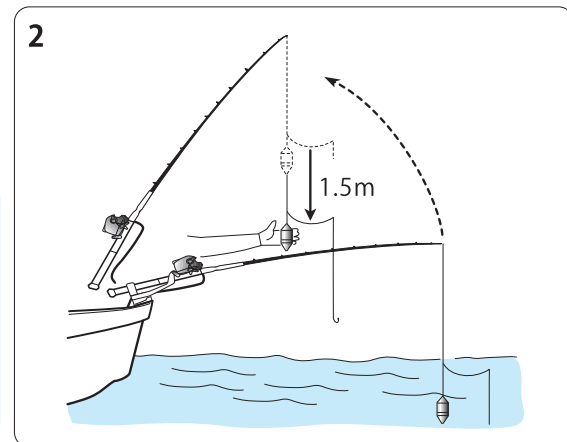

3. When the line length has been properly adjusted, press and hold the **INVCNTR. BUTTON** for about 2 seconds.

Setting is completed when you hear "Beep" sound.

\*Auto stop is set to 2.0 m by default.

(If **RESET BUTTON** is not pressed, the reel stops at 5.0 m)

4. The electrical winding up automatically stops at the pre-set point. So, raise the rod tip to bring your terminal rig to your hand side.

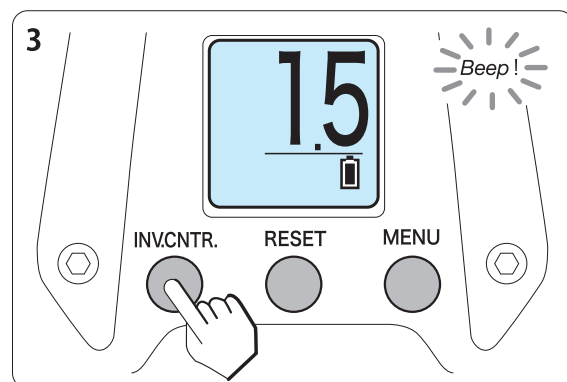

# Functional setting [5. INVERSE COUNTER]

The inverse counter can be displayed below the water depth counter.  
 \*The inverse counter is set to OFF by default.

## Inverse counter

You can easily identify a shelf in the strike zone for fishing with the distances from the boat and from the bottom by two counters.

1. Press **MENU** **BUTTON** to go to the MENU screen.

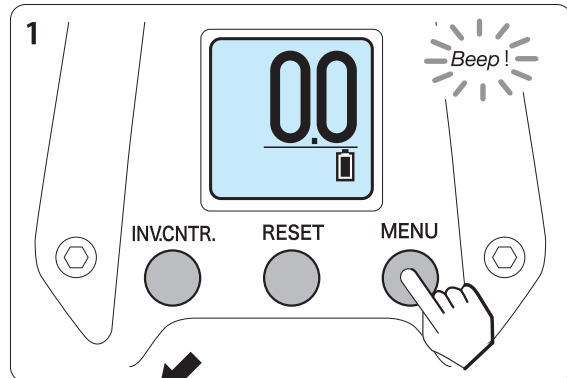

2. Select "INVERSE COUNTER" with the Power Lever and press **OK** (**MENU** **BUTTON**). Then, select ON with the Power Lever and press **OK** (**MENU** **BUTTON**).

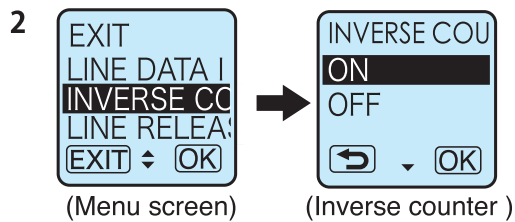
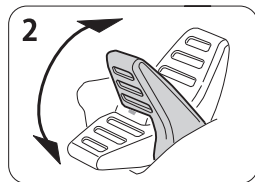

3. Return to the MENU screen and press **EXIT** (**INVCNTR.** **BUTTON**).

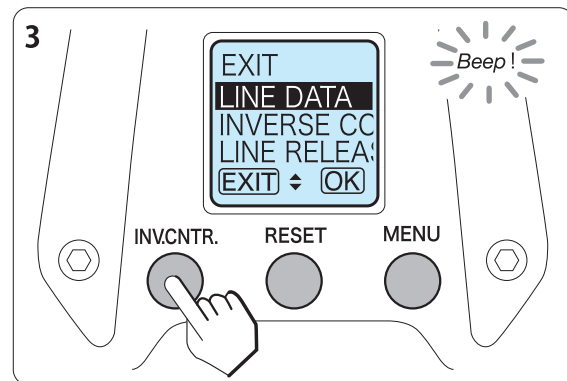

4. The Inverse counter will appear below the Water Depth counter.

5. When you press the **INVCNTR.** **BUTTON** at the depth in the strike zone for fishing after lowering the terminal rig, including the bottom and your aiming shelf, the Inverse counter displays **0.0** as the reference point for showing the distance from such point.

Press **EXIT** (**INVCNTR.** **BUTTON**).



(Returns to the water depth counter)

### Attention

*-If the battery voltage is low, the inverse counter is not displayed and the Battery mark is preferentially displayed.*

# Functional setting [6. Line feeding function]

## Line feeding function

Motor gear reverses to allow the spool to rotate in the direction of the line going out that assists line feeding.

## LINE RELEASE ASST

1. Press **MENU** **BUTTON** to go to the MENU screen.
2. Select "LINE RELEASE ASST" with the Power lever and press **OK** ( **MENU** **BUTTON** ). Then, select "ON" with the Power Lever and press **OK** ( **MENU** **BUTTON** ) to complete the setting.

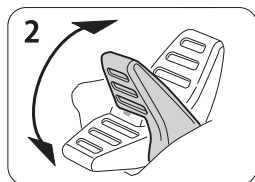

3. It returns to the MENU screen. Press **EXIT** ( **INVCNTR.** **BUTTON** ) to return to the water depth screen.

- When you turn the Clutch to OFF and throw your terminal rig into the water, the line feeding function will be activated from the preset auto stop depth plus 2.5 m.
- The line feeding output will be automatically adjusted according to the speed of the spool rotation with the terminal rig dropping.
- If the Power Lever moved while feeding the line, the line feeding will be stopped.
- Once the line feeding is stopped for more than a certain time due to backlash etc., it will not restart.

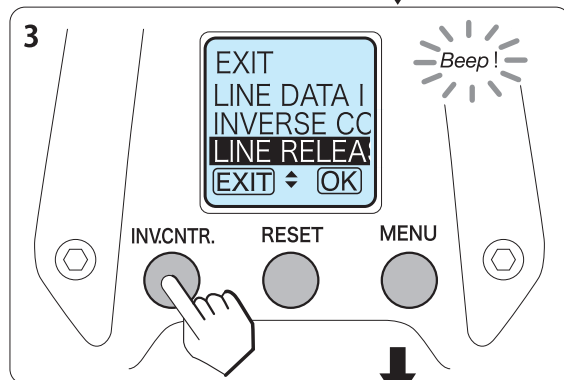
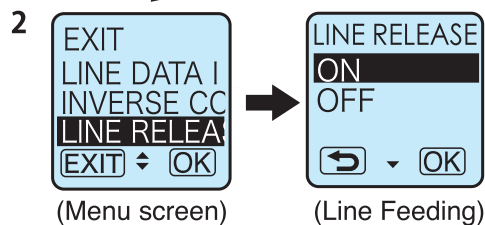
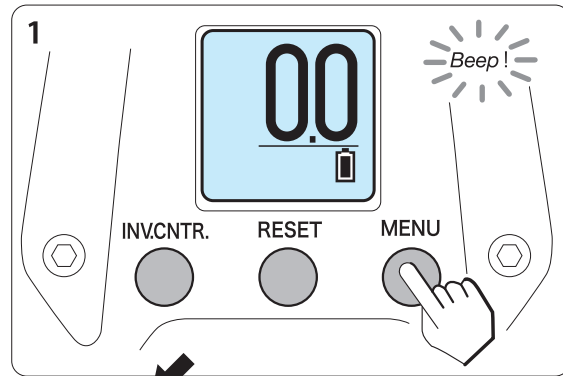

### Attention

- If you turn the Clutch to ON during the line feeding (motor in operation), the line may get wound.
- If you throw your terminal rig into the water with the Line Feeding set to ON in the condition where the boat intensely moves up and down or the wind is strong, backlash easily occurs, which may interfere the smooth dropping of your terminal rig.

# Functional setting [7. Chumming Timer]

## Chumming Timer

The display shows precisely the time having elapsed every since the rig was dropped. It is very helpful to determine the pace for checking and changing of baits and sinkers.

- The display shows the time having elapsed since lowering of the rig started. This can be used as a reference for the timing to retrieve the rig.
- The Chumming Timer automatically starts from 7.0 m displayed on the water surface counter after throwing your terminal rig into the water.

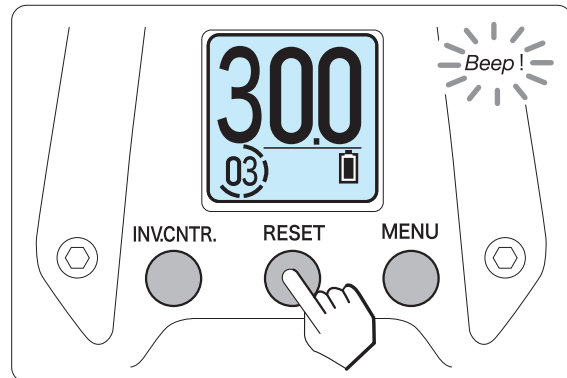

- \*The time is indicated in seconds if the remaining time is less than 60 seconds. It is indicated in minutes if the remaining time is not less than 1 minute.
- \*The timer function may not be reset.
- \*For proper use of the timer, your next terminal rig feeding shall be made only after winding it up to the auto stop position at the boat side.

### Attention

If you press the **INVCNTR. BUTTON** while chumming is in process, the timer indication will start from **0**.

# Functional setting [8. HISTORY]

## HISTORY

You can check the total line winding-up length and the total hours of use of your electric reel.  
\*There may be a bit of measuring errors in the Indicated values.

1. Press **MENU** **BUTTON** to go to the MENU screen.

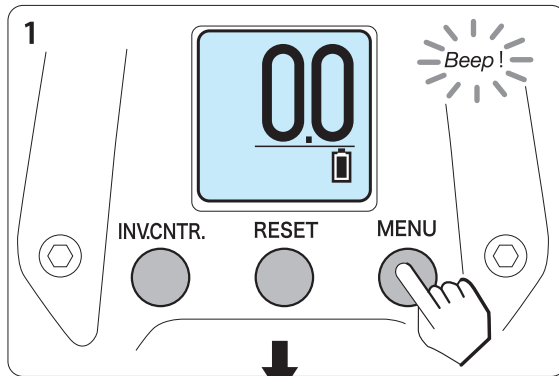

2. Select "HISTORY" with the Power Lever and press **OK** ( **MENU** **BUTTON** ).

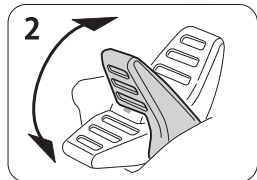

3. You can check the total line winding-up length and total hours of use.  
Press **OK** ( **MENU** **BUTTON** ) to return to the Menu screen.

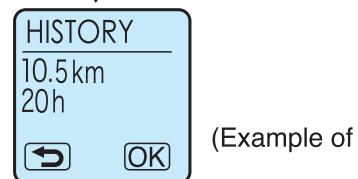
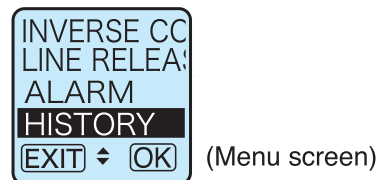

4. Press **EXIT** ( **INVCNTR.** **BUTTON** ) from the MENU screen to return to the water depth screen.

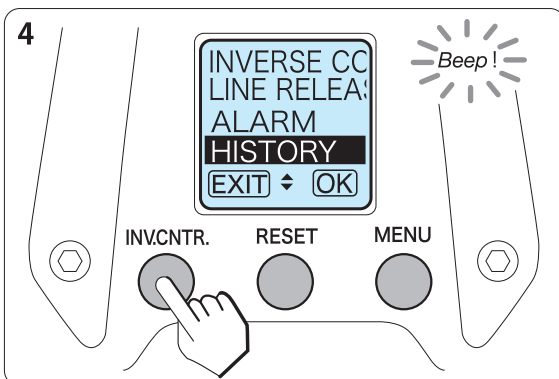

# Functional setting [9. Other useful functions]

## Various alarms

Many kinds of information are indicated by audible alarms such as auto stop alarm and range memory alarm.



### Power Lever alarm

-When you place the Power Lever at MAX or OFF position, an alarm beeps to tell you its position.

### Auto stop alarm

-While winding up, an alarm shortly beeps starting 6 m below the auto stop point, at two meter intervals, to tell you that the rig is coming closer to the auto stop point. When it reached the auto stop point, an alarm sounds for longer.

### Range memory alarm

-While lowering your rig back into the strike zone, an alarm shortly beeps starting 10 m above the memorized depth range of the strike zone, at 2 m intervals, to tell you that the rig is reaching closer to the strike zone. When the rig reached the strike zone, an alarm sounds for longer.

\*This zone memory alarm is designed not to sound unless the line has been wound more than 6 m above the memorized depth and the line is fed again for the purpose of preventing the alarm from frequently sounding while seeking the strike zone.

The range memory alarm can be enabled by setting the inverse counter.

### Switch alarm

-Each time a button is pressed, a beep is sounded to allow you to confirm that you have surely pressed a button (You can set this alarm to OFF in the setting of functions from the Menu screen).

### Excessive voltage alarm

-If you connected a power source with a voltage higher than the acceptable range, a continuous alarm will sound to warn you to stop operation. DO NOT operate the reel with such battery.

## ALARM ON/OFF setting

You can set the alarm sound to OFF.

-It is set to ON by default.

-Once the alarm sound has been set to OFF, the alarm will no longer sound even if you have pressed buttons or have used the power lever for operation.

1. Select "ALARM" in the Menu screen.
2. Select OFF with the Power Lever.
3. Press **OK** ( **MENU** **BUTTON** ) to complete setting.
4. Press **EXIT** ( **INVCNTR.** **BUTTON** ) in the MENU screen to return to the water depth screen.

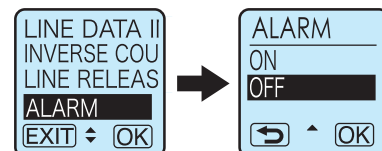

# Functional setting [9. Other useful functions]

## LANGUAGE(言語) setting

You can select any language to be displayed on the LCD screen from the options: English / Japanese / Traditional Chinese / Simplified Chinese / Spanish / French / Germany / Italian / Korean.

1. Select "LANGUAGE(言語)" in the Menu screen.
2. Select your desired language with the Power Lever.
3. Press **OK** ( **MENU BUTTON** ), If the screen returns to the "MENU screen", then the setting is completed.
4. Press **EXIT** ( **INV.CNTR. BUTTON** ) in the MENU screen to return to the water depth screen.

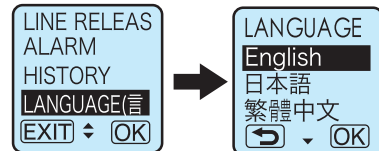

## UNIT setting

You can select "m" (meter) or "ft" (feet) for a unit to be used for the length.

\*Note that the unit is represented in "m" (in meters) only when entering a value in "LINE DATA INPUT" even if "ft" (in feet) has been set for the unit.

1. Select "UNIT" in the Menu screen.
2. Select your desired language with the Power Lever.
3. Press **OK** ( **MENU BUTTON** ), If the screen returns to the "MENU screen", then the setting is completed.
4. Press **EXIT** ( **INV.CNTR. BUTTON** ) in the MENU screen to return to the water depth screen.

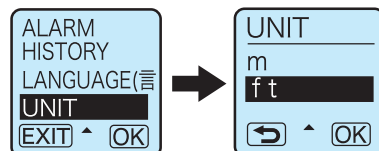

## Counter lamp

The lamp built in the counter always lights up.

- While the reel is powered ON, backlighting of the display always provides easier reading for fishing in the dark.

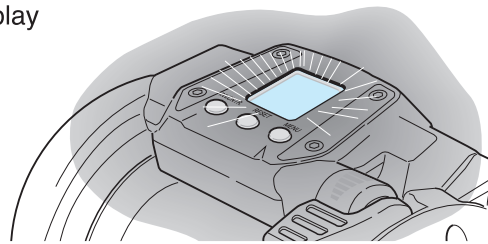

## Circuit breaker display

- When an excessive heavy load is applied on the reel or an excessive temperature rise is detected, the circuit breaker will be tripped and the winding operation will be stopped to prevent damage to the reel body. It stops for 5 seconds if an excessive load is applied, or for 15 seconds if an excessive temperature rise occurs.

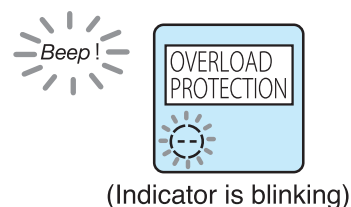



# Functional setting [10. How to remove the handle knob]

1. Holding the handle knob with your hand, loosen the handle knob cap by turning it counter-clockwise to loosen using a coin and remove it.

\*Be sure to fit a coin properly onto the groove on the handle knob cap before turning it. Otherwise, the handle knob cap will be damaged while turning it.

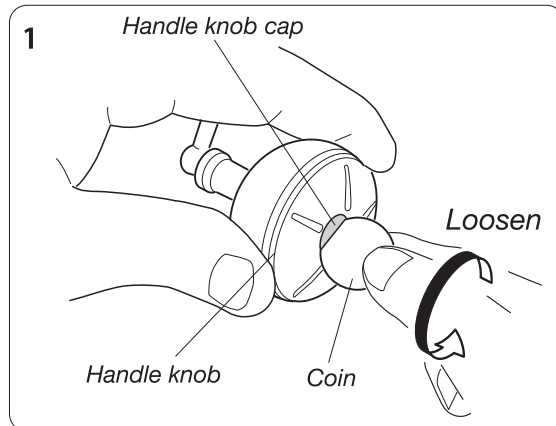

2. Loosen and remove the screw fixed inside of the knob using a screw driver.

\*Note that the screw is coated with a slack preventing agent and it is hardly loosened. Be careful not to damage the screw head.

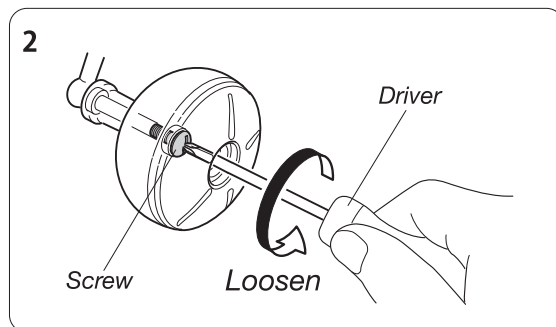

3. The handle knob is composed of as shown in the figure.

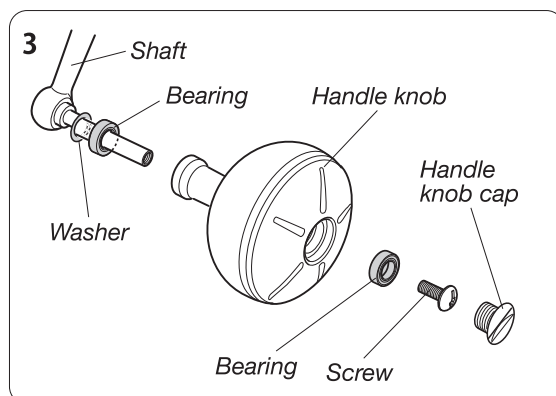

# How to fix the Rod Clamp

When you use a metallic bat or for your fishing of a big charge, you should always utilize the Rod Clamp.  
(Using the Rod Clamp, it is possible to clamp rods with diameter up to 25-34mm)

1. Insert the Bolt in the clamp setting hole, and fix it by tightening the Nut and the Washer.

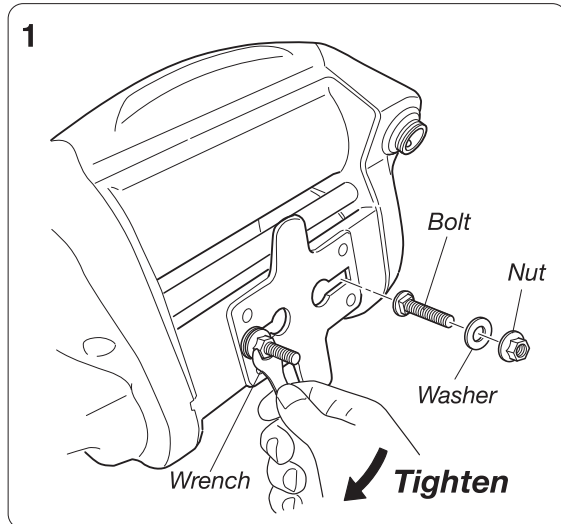

2. Hold the rod in position while attaching the clamp.  
Tighten the rod clamp nuts to secure.  
To fix the reel with a rod clamp apply the screws to the reel foot then place the rod between the threads then add the clamp and tighten the nuts.

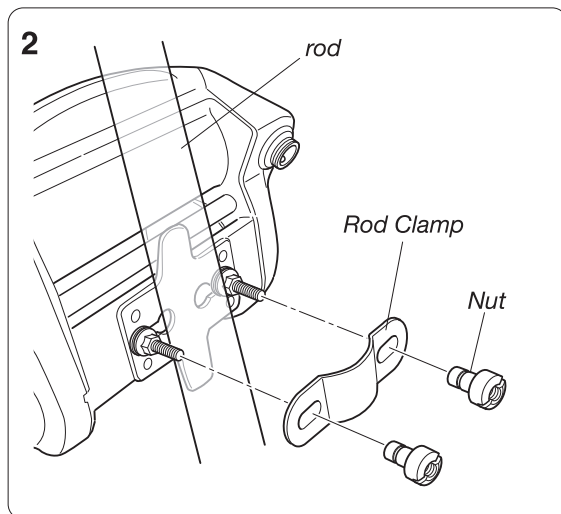

  
**Attention**

- If the Nut is tightened too firmly, there is a danger of deforming the rod depending upon rod material, especially with composite rods and reel seats.

# Reel Specifications

## Reel Specification list

TANACOM 1200

<b>UPC CODE</b>		0 43178 61594 2
<b>GEAR RATIO</b>		2.1:1
<b>REEL WEIGHT</b>		2,040 g (72.0 oz)
<b>DRAG MAX</b>		25 Kgf (50 lb)
<b>LINE CAPACITY</b>	<b>PE (J-BRAID)</b>	60 (lb) - 1,300 m (1,400 yds)
		80 (lb) - 1,000 m (1,100 yds)
		100 (lb) - 800 m (850 yds)
		120 (lb) - 600 m (650 yds)
	<b>NYLON MONOFILAMENT</b>	30 (lb) - 800 m (850 yds)
		40 (lb) - 550 m (600 yds)
<b>BALL BEARINGS</b>		4 qty
<b>POWER SUPPLY VOLTAGE</b>		DC : 16.8V
<b>MOMENTARY MINDING POWER</b>		35.1 Kgf (70 lb)
<b>NO-LOAD WINDING SPEED</b>		140 (m/min)
<b>CURRENT VALUE</b>	<b>NO-LOAD</b>	4.5 A
	<b>RATED</b>	6
	<b>MAX</b>	36 A

## Counter display

<b>Depth display range</b>	Upper counter: 0 to 9,842 ft (3,000 m) Lower counter: - 9,842 ft (- 3,000 m) to 9,842 ft (3,000 m)
<b>Usable temp. range</b>	-50°F (-10°C) to +140°F (60°C)

\*The specifications are subject to change without prior notice for product improvement.



# Parts List

## TANACOM 1200

No.	Parts Name	No.	Parts Name	No.	Parts Name	No.	Parts Name
1	RS RING	73	MOTOR HOLDER(B) WASHER	140	SPOOL PLATE BALL BEARING	203	DRAG COLLAR
2	PARMING PLATE(A)	74	MOTOR HOLDER(B) PLATE	141	SPOOL PLATE BALL BEARING WASHER(B)	204	HANDLE BALL BEARING
3	PARMING PLATE(B)	75	LS SET PLATE WASHER	142	BALANCE ADD WASHER(D)	205	POWER LEVER
4	PARMING PLATE(C)	80	LS SET PLATE SCREW(A)	143	SPOOL GEAR(B) RETAINER	210	POWER LEVER O RING(A)
5	STAND	81	LS SET PLATE SCREW(B)	144	SET PLATE COLLAR	211	JOG POWER LEVER O RING(B)
10	RS RING SCREW	82	SPOOL	145	SET PLATE COLLAR WASHER	212	JOG POWER LEVER COLLAR
11	RS RING SCREW WASHER(A)	83	MOTOR HOLDER(A) WASHER	150	SET PLATE COLLAR SCREW	213	RS PLATE
12	RS RING SCREW WASHER(B)	84	MOTOR HOLDER(A) RING	151	FINGER COVER	214	CLUTCH LEVER WASHER
13	LS SET PLATE	85	SPOOL GEAR(A)	152	FINGER COVER SCREW	215	BALANCE ADD WASHER(E)
14	LS SET PLATE SCREW	89	SPOOL GEAR COLLAR	153	IC MODULE COVER	220	CLUTCH LEVER
15	LS SET PLATE SCREW WASHER(A)	90	SPOOL GEAR WASHER	154	IC MODULE	221	CLUTCH LEVER SCREW
20	LS SET PLATE SCREW WASHER(B)	91	SPOOL GEAR BEARING	155	IC MODULE COVER SCREW(A)	222	CLUTCH CAM
21	WORM SHAFT COLLAR(A)	92	SPOOL GEAR(B)	159	SENSOR SCREW	223	CLUTCH CAM SPRING
22	LEVEL WIND	93	SPOOL PLATE COLLAR	160	FERRITE CORE	224	CLUTCH CAM WASHER
23	PAWL	94	SPOOL PLATE	161	IC MODULE COVER SCREW(A)	225	CLUTCH CAM SCREW
24	PAWL WASHER	95	SPOOL PLATE SCREW	162	SENSOR SCREW	230	LINE STOPPER
25	PAWL HOLDER NUT	100	SET PLATE	163	LS PLATE	231	RS PLATE SCREW(A)
30	WORM SHIELD	101	IDLE GEAR(A) COLLAR	164	LS PLATE SCREW	232	RS PLATE SCREW(B)
31	WORM SHAFT	102	IDLE GEAR(A)	165	CORD COVER	233	HANDLE BEARING WASHER
32	WORM SHAFT COLLAR(B)	103	IDLE GEAR(A) SCREW	170	PLATE	234	DRAG SPRING WASHER
33	WORM SHAFT GEAR WASHER	104	IDLE GEAR(B) COLLAR	171	PLATE SCREW	235	DRAG HOLDER
34	WORM SHAFT GEAR	105	IDLE GEAR(B)	172	PINION GEAR	240	DRAG LEAF SPRING
35	WORM SHAFT RETAINER	110	IDLE GEAR(B) WASHER	173	CLUTCH PLATE	241	STAR DRAG WASHER
40	BALANCE ADD WASHER(A)	111	IDLE GEAR(B) SCREW	174	SLIDE PLATE	242	STAR DRAG
41	WORM SHAFT WASHER	112	GEAR SHAFT BUSH	175	CLUTCH PLATE SPRING	243	HANDLE COLLAR
42	WORM SHAFT RETAINER	113	GEAR SHAFT	180	RS BALL BEARING	244	HANDLE
43	POST	114	GEAR SHAFT WASHER	181	STOPPER PIN	245	HANDLE NUT
44	MOTOR HOLDER(A)	115	BALANCE ADD WASHER(B)	182	STOPPER SPRING	250	HANDLE CAP
45	MOTOR	120	GEAR SHAFT RETAINER	183	STOPPER	251	HANDLE CAP SCREW
50	MOTOR CORD(RED)	121	ZERO ADJUSTER KNOB WASHER	184	RATCHET	252	CONNECTOR CAP
51	MOTOR CORD(BLACK)	122	ZERO ADJUSTER KNOB SPRING	185	RATCHET WASHER	253	CORD
60	MOTOR HOLDER(A) SCREW O RING	123	ZERO ADJUSTER KNOB	190	DRIVE GEAR WASHER	254	FERRITE CORE
61	MOTOR HOLDER(A) SCREW	125	ZERO ADJUSTER KNOB RETAINER	191	GEAR SHAFT O RING	900	CLAMP SCREW
62	MOTOR HOLDER(B)	126	ZERO ADJUSTER WASHER(A)	192	DRIVE GEAR	901	CLAMP SCREW WASHER
63	MOTOR COLLAR WASHER	130	ZERO ADJUSTER WASHER(B)	193	DRAG WASHER	902	CLAMP SCREW NUT
64	MOTOR COLLAR	131	ZERO ADJUSTER WASHER(C)	194	DRAG LIP WASHER	903	CLAMP PLATE
65	MOTOR HOLDER(B) PACKING	132	ZERO ADJUSTER WASHER(D)	195	DRAG DISC WASHER	904	CLAMP PLATE NUT
70	MOTOR HOLDER(B) O RING	133	SET PLATE SCREW	200	DRAG PACKING	905	LINE THROUGH PIN
71	MOTOR HOLDER(B) SCREW	134	SPOOL PLATE BALL BEARING WASHER(A)	201	DRAG O RING		
72	MOTOR HOLDER(B) COLLAR	135	BALANCE ADD WASHER(C)	202	DRAG DISC COLLAR		

There may sometimes be a difference between the purchased reel and the Dismantled Parts Chart or the parts list above due to the adjustment process etc. We appreciate your understanding.

# Trouble shooting

Symptom	Possible causes	To do	Ref. page
Motor does not respond to the power lever.	The counter displays 2.0 m.	It is a normal function to avoid over winding.	P32
	Did not pull the lever to OFF position.	Pull the lever to OFF and then move forward again to start winding.	P16
	Unstable power source.	Use another power source, such as electric reel specific batteries.	P11
	The clutch has been turned OFF.	Turn ON the clutch to restart winding-up.	P16
Counter display does not appear.	Battery charge is low.	Recharge the battery.	P11
	Cord worn or corroded.	Replace the cord.	P14
	Incorrect battery connection.	Connect clips correctly without + / - reverse connection.	P10
Auto stop function does not work.	Did not press RESET BUTTON at surface.	Set the surface depth to zero after setting rig.	P31
	Error for sinker weight or rocking of the boat.	Adjust settings of auto stop function.	P32
	Line is elongated.	Reset the depth counter at the surface.	P31
There are counter errors.	Line length has increased due to stretching.	Re-enter line data.	P21~30
	Line was wound while powered off during fishing.	Re-enter line data.	P21~30
	RESET BUTTON was pressed and held while feeding the line.	Re-enter line data.	

\*Contact your dealer if the reel does not function properly despite the above details being confirmed, in the event of other problems arising, and to order parts.

# Reference

## **Daiwa Corporation**

11137 Warland Drive,  
Cypress, CA 90630,U.S.A.  
Phone: 0562-375-6800  
[www.daiwa.us](http://www.daiwa.us)

## **Daiwa (Australia) Pty.Ltd.**

Unit G, 134-140 Old Pittwater Road,  
Brookvale, NSW 2100, Australia  
Phone: 02-8644-8644  
[www.daiwafishing.com.au](http://www.daiwafishing.com.au)

## **Daiwa France S.A.S.**

25 Boulevard Industriel,76300  
Sotteville-Lès - Rouen, France  
Phone:02-32-91-98-50  
[www.daiwa.fr](http://www.daiwa.fr)

## **Daiwa Germany GmbH**

Georg-Brauchle - Ring 23-25,  
D- 80992 München, Germany  
Phone: 089-309065-0  
[www.daiwa.de](http://www.daiwa.de)

## **Daiwa Sports Ltd.**

Netherton Industrial Estate,  
Wishaw, ML2 0EY, Scotland,U.K.  
Phone:01698-355-723  
[www.daiwasports.co.uk](http://www.daiwasports.co.uk)

## **Daiwa Italy S.r.l.**

Via Polesine 13 20139  
Milano, Italy  
Phone: 02-8725-0585  
[www.daiwaitaly.it](http://www.daiwaitaly.it)

## **Daiwa Rus LLC**

Krasnoproletarskaya str. 16/2,  
office III, room12, Moscow,  
127473, Russian Federation  
Phone: 0495-223-71-68  
[www.daiwarus.com](http://www.daiwarus.com)

## **Daiwa FT Enterprise (Taiwan) Co.,Ltd.**

No.70-2 Yueh Hu Road,  
Tun Pei Village, Hou Li District,  
Taichung city, Taiwan  
Phone: 04-2556-5099  
[www.daiwaseiko.com.tw](http://www.daiwaseiko.com.tw)

## **Daiwa Sports (M) SDN.BHD.**

No.1929, Jalan Industri Permatang  
Batu, Permatang Batu,14000 Bukit  
Mertajam, Pulau Pinang, Malaysia  
Phone: 04-540-4457  
[www.daiwa.my](http://www.daiwa.my)

## **Daiwa Sports (Guangzhou) Co.,Ltd.**

1202 No.1 Longxidong Road,  
Liwan District,  
Guangzhou, China. 510375

## **LIMITED WARRANTY TERMS**

WARRANTY WILL EXPIRE WHEN ONE OF THE  
FOLLOWING HAS BEEN SURPASSED.

\*ONE YEAR FROM DATE OF ORIGINAL  
PURCHASE.

\*200 TOTAL HOURS OF USE.

## **GARANTIE**

LA GARANTIE EXPIRE LORSQUE L'ON  
ATTEINT.

\*SOIT 1 AN APRES L'ACHAT.

\*SOIT 200 H D'UTILISATION.

## **TERMINOS DE GARANTÍA LIMITADOS**

La garantía caducará cuando algo de lo siguiente  
se haya sido superado.

\*Un año de la fecha de la compra original.

\*200 horas totales de uso.