

flytta[®] Riser 90

ASSEMBLY GUIDE

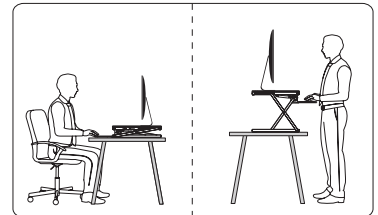

TECHNICAL DATA

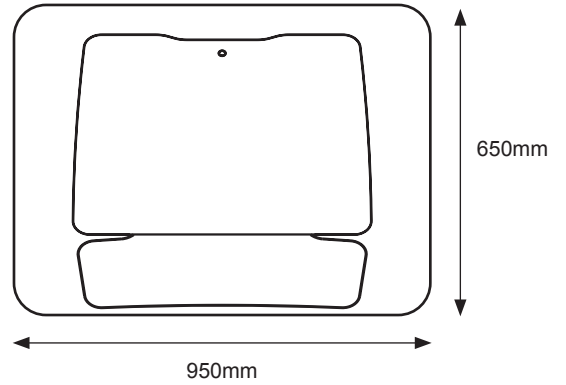
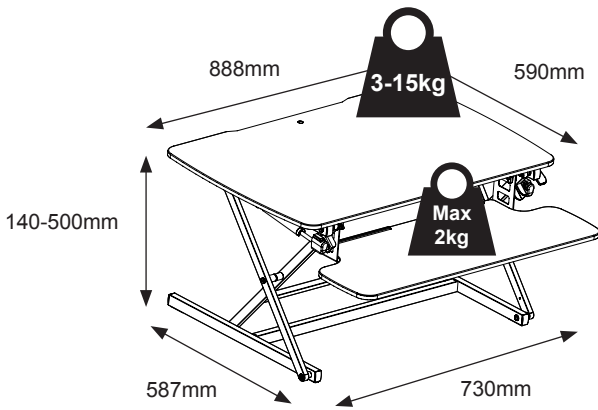

IMPORTANT: Do not exceed the MAXIMUM bearing weight

IMPORTANT: Surface must be larger than 950mm x 650mm.

WHAT'S IN THE BOX

A x1

B x1

C x4

D x1

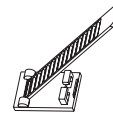
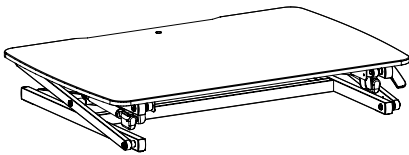

STEP 1.

Take the product out of the box and place it on the table.

IMPORTANT: Place the product on a table large, strong surface, or it may cause harm or damage.

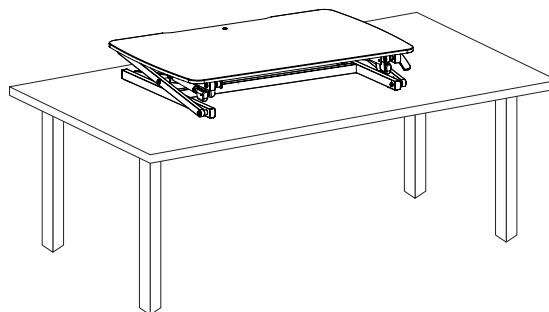

STEP 2.

Hook the keyboard tray onto the installed knob, then tighten the knob.

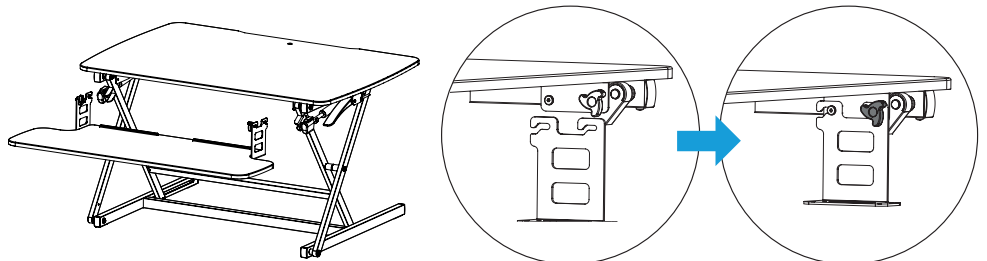

STEP 3.

Pull the handle upwards and adjust the workstation to your desired working height.

IMPORTANT: Do not put your hands near the supporting bars while adjusting the desk height. The bars move and could cause harm if obstructed.

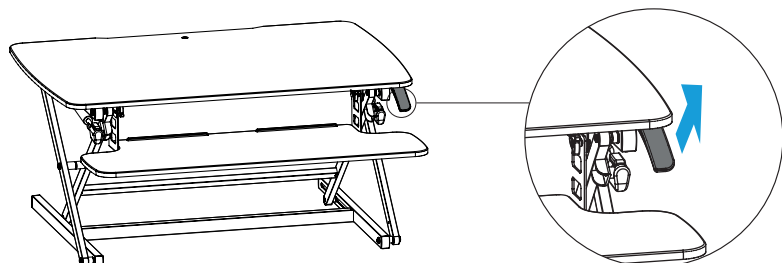

STEP 4.

Put your devices entirely on top of your assembled workstation.

IMPORTANT: Do not allow any of your equipment to stick out over the edges, it may cause harm or damage.



STEP 5.

Use the self-adhesive nylon ties to attach the cables to the underside of the desktop.

IMPORTANT: Make sure there is enough cable length for the full height of the desk riser, otherwise it may cause damage.

Use the velcro strap to gather your cables together to avoid loose cables getting caught in the mechanism.



IMPORTANT:

1. Before removing any equipment, adjust the desk riser to its highest setting to avoid harm or damage.
2. It is safer for two people to move the desk riser; moving it alone could cause damage or harm.

Support contact

Telephone: 0333 22 00 375

Email: sales@yo-yodesk.co.uk