











 Model	EW820	
Code Production	TT3823EWNZ2CDD	
Interface :		
		

	Overall Dimension (Width-Depth-Height) *open	mm	721 - 836 - 1565(*2080)
	Packaging Dimension (WxDxH)	mm	870x760x1540
	Gross weight	Kg	121
	Net weight	Kg	111
	Volume	mc	1,02
	Rack size	mm	500x500
	Max door /hood opening	mm	465
	Max glasses/plate Height	mm	440
	General construction		double skin
	Door/hood Construction		double skin
	Tank construction		deep drawn
	Tank volume	liter	22
	Tank heating element	W	2.500
	Tank surface strainers		Yes- composite
	Wash pump type		double flow
	Wash pump power	W	700
	Wash temperature	°C	60
	Boiler type		without pressure
	Boiler volume	liter	12
	Back-flow system		break tank
	Boiler heating element	W	6.000
	Rinse booster pump		yes
	Rinse booster pump power	W	200
	Rinse temperature	°C	80
	Rinse water consumption	Liter /rack	1,9
	Optimal external water pressure	bar	1 - 4
	Drain system		deep drain
	Drain pump		standard built in
	Rinse aid dispenser	peristaltic	YES
	Detergent dispenser	peristaltic	YES
	Wash cycle	sec	60 - 90 - 180
	Special cycle	programs	n°8
	Self cleaning cycle		yes
	Electric Power	W	6.700
	Electric Connection	V - ph - Hz	400V 3N 50Hz
	Fuse	A	16
	Plates racks	n° 1	780131
	Flat Rack	n° 1	780132
	Cutterly Rack	n° 1	780139
	Electric cable	n° 1	YES
	Drain hose	n° 1	YES
	Fill hose "WaterMark"	n° 1	YES

A		∅ 32 mm
B		G 3/4"
C		Power supply



* LUCE UTILE PER CESTELLO
USEFUL SPACE FOR BASKET
LUMIERE UTILE POUR PANIER
NUTZBARER OFFENUNG FÜR KORBE
ABERTURA UTIL. PARA CESTO

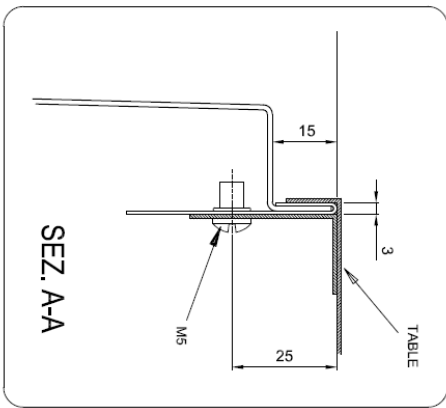
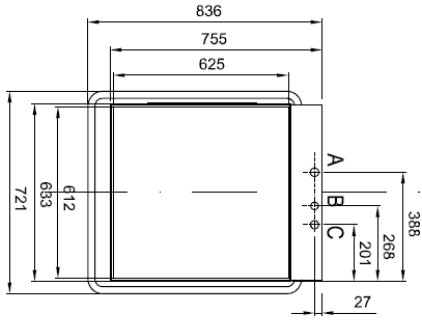
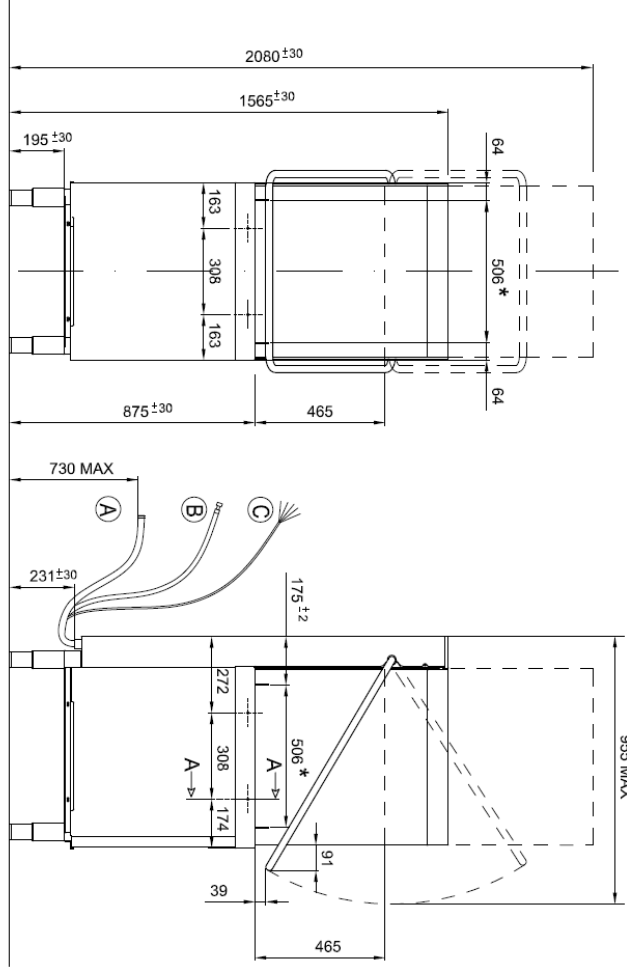

Designed by:	M.FUCCI	Date:	03.12.2013	Denomination:	Hood type with drain pump	Code:	73991	Rev.:	01
--------------	---------	-------	------------	---------------	---------------------------	-------	-------	-------	----

