



B+S BLACK SERIES: CBR-6

600mm Char Broiler on Stand

Project: _____ Item: _____



CBR-6

Standard Features:

- AISI Grade Stainless Steel
- Heavy duty complete stainless steel frame with undershelf
- 34MJ stainless steel U-Burner per 300mm section
- Heavy duty cast iron J-Grates & Radiant Hoods
- Reversible J-Grates allow for an inclined or flat cooking surface
- Flame Failure - Included as standard
- Piezo ignition to pilot char broiler burner
- Multi-setting gas valve – Allows greater regulation of flame setting
- Easy access to all components for servicing and adjustments
- Easy to clean fat spillage trays

Options:

- Natural or LPG Gas
- Non-swivel rear castors – Set of two

Specifications:

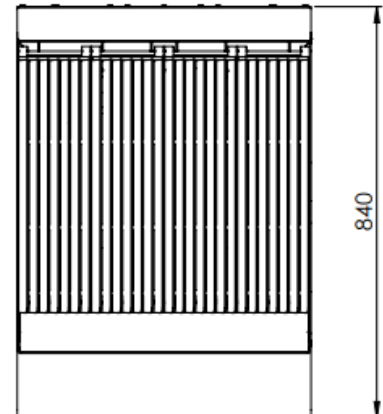
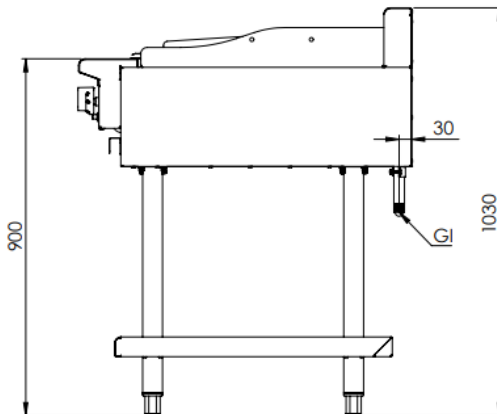
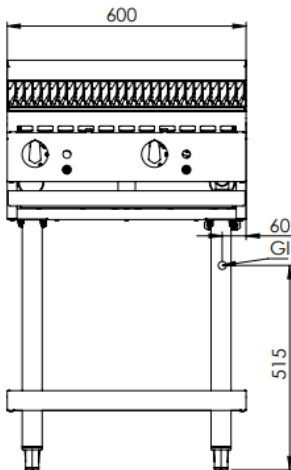

MODEL	LENGTH (mm)	DEPTH (mm)	HEIGHT (mm)	NET WEIGHT (kg)	GAS CONSUMPTION (Mj/h)	
					NG	LPG
CBR-6	600	840	1030	-	68	60

Connections:

GAS (GI) (BSP)	SUPPLY PRESSURE (kPa)	
	NG	LPG
3/4" (M)	1.0	2.6

- Gas regulator is included with the unit
- **Must** be installed by an authorised installer in accordance to **AS/NZS5601** refer to **current version**

Due to ongoing Product Development, Product Improvement and Research, B+S Commercial Kitchens reserves the right to alter specification without notice.

Approval Number: GMK 10686



B+S Commercial Kitchens
57 Plateau Road Reservoir VIC 3073 Australia | +61 3 9469 4754
info@bscommercialkitchens.com | www.bscommercialkitchens.com

