



B+S BLACK SERIES: BT-SB2-GRP6

Combination Two Open Burners & 600mm Grill Plate on Stand

Project: _____ Item: _____



BT-SB2-GRP6

Standard Features:

- AISI Grade Stainless Steel
- Heavy duty complete stainless steel frame with undershelf
- 31MJ black enameled Italian made burner (BT)
- 22MJ aluminised tube burner per 300mm section (GRP)
- Heavy duty Italian made vitreous enameled trivets
- Heavy duty mild steel grill plate (16mm Thick)
- Italian made top welded smooth finish design
- Removable pressed top spillage tray for easy cleaning
- Removable heavy duty two-piece burner for easy cleaning
- Flame Failure - Included as standard
- Piezo ignition to pilot grill plate burner
- Multi-setting gas valve – Allows greater regulation of flame setting
- Easy access to all components for servicing and adjustments
- Easy to clean fat spillage trays

Options:

- Natural or LPG Gas
- PLT – With Pilot
- Non-swivel rear castors – Set of two
- Chrome Plating

Specifications:

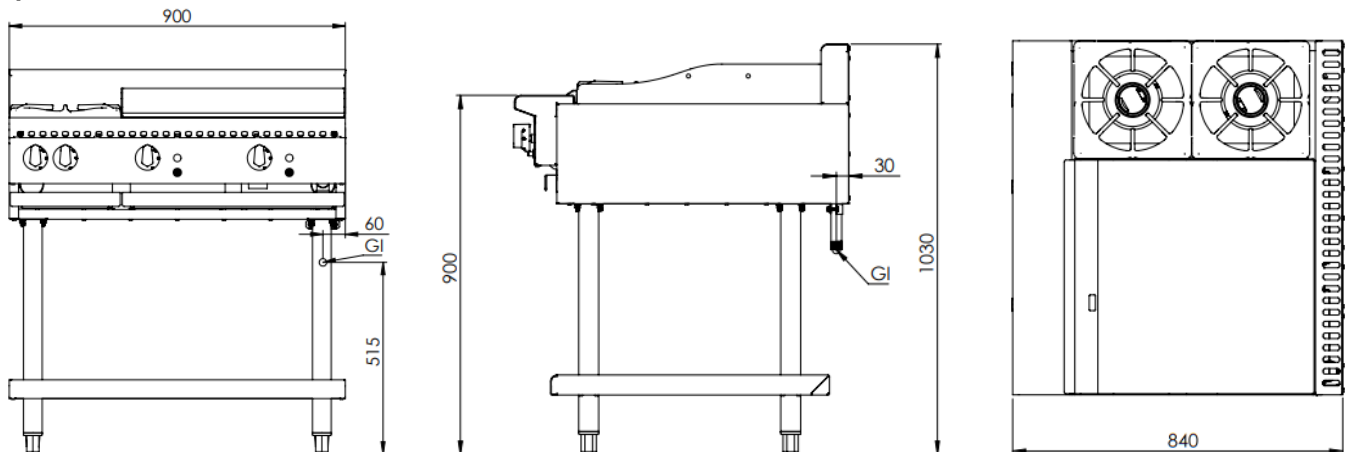

MODEL	LENGTH (mm)	DEPTH (mm)	HEIGHT (mm)	NET WEIGHT (kg)	GAS CONSUMPTION (Mj/h)	
					NG	LPG
BT-SB2-GRP6	900	840	1030	-	106	94

Connections:

GAS (GI) (BSP)	SUPPLY PRESSURE (kPa)	
	NG	LPG
3/4" (M)	1.0	2.6

- Gas regulator is included with the unit
- **Must** be installed by an authorised installer in accordance to **AS/NZS5601** refer to current version

Due to ongoing Product Development, Product Improvement and Research, B+S Commercial Kitchens reserves the right to alter specification without notice.

Approval Number: GMK 10686



B+S Commercial Kitchens
57 Plateau Road Reservoir VIC 3073 Australia | +61 3 9469 4754
info@bscommercialkitchens.com | www.bscommercialkitchens.com

