

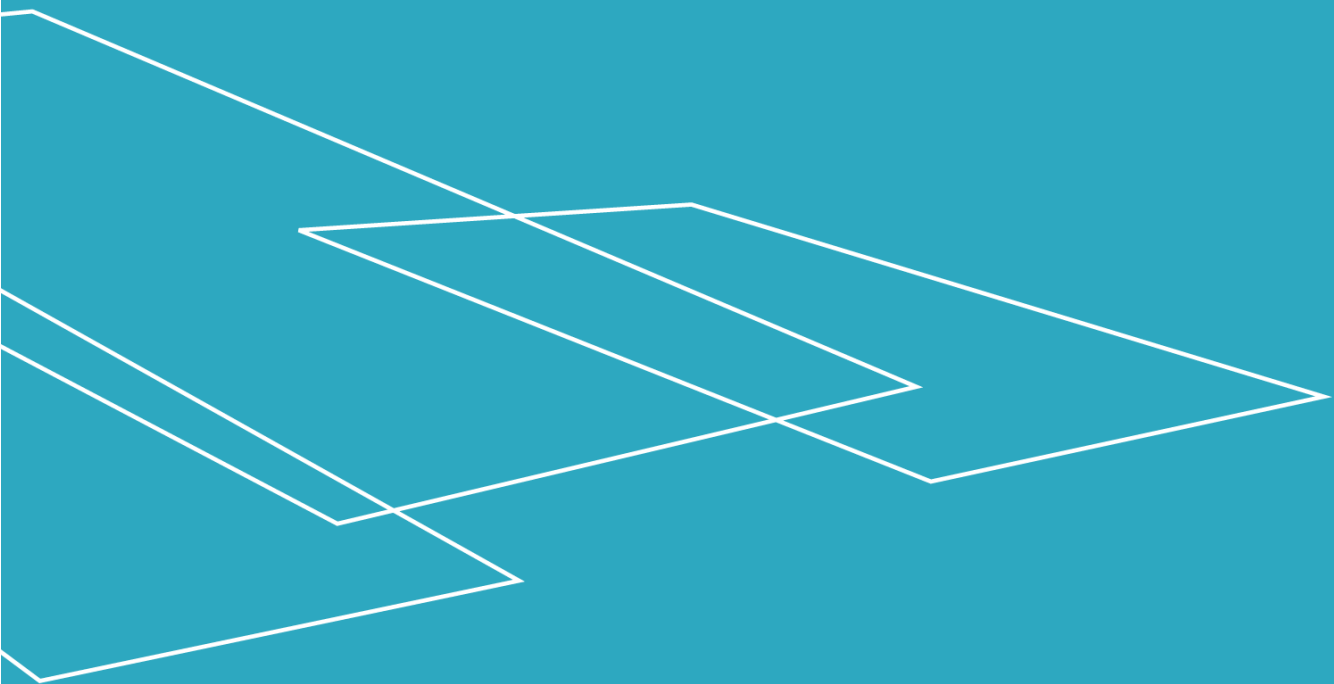

User Manual RAIZER®

USER MANUAL – RAIZER® – US VERSION 1.10



Content

- Content 2
- 1. Foreword..... 4
 - 1.1 Quick Guide 4
- 2. Declaration 5
 - 2.1 Regulatory Approvals..... 7
 - 2.2 EU Declaration of conformity..... 9
- 3. Type certificate 10
- 4. Intended use 11
- 5. Technical specifications..... 12
 - 5.1 Raizer Lifting chair 12
 - 5.2 Remote control 13
 - 5.3 Charger..... 13
- 6. Safety instructions..... 14
 - 6.1 Assembly 14
 - 6.2 Avoiding personal injury..... 14
 - 6.3 Overload. 14
- 7. Personal safety 15
 - 7.1 Avoiding personal injury 15
 - 7.2 Seatbelt..... 15
 - 7.3 Handling..... 15
- 8. Functionality 16
- 9. Prior to use..... 17
- 10. Operation..... 18
 - 10.1 Assembly and use of the Raizer® 18
 - 10.2 Assembly of left-hand side 19
 - 10.3 Assembly of right-hand side 20
 - 10.4 Lifting of person 22
 - 10.5 Operation of the Raizer® by means of seat buttons 24
 - 10.6 Operation of the Raizer® by means of remote control* 26
 - 10.7 How to pair the remote control transmitter and receiver 27
- 11. Disassembly 28
- 12. Charging of the Raizer® 29
- 13. Maintenance..... 30
 - 13.1 Cleaning:..... 30
 - 13.2 Mechanical maintenance 30



- 13.3 Remote control*30
- 14. Maintenance checklist31
- 15. Service log book33
- 16. Spare parts34
- 17. Troubleshooting40
- 18. Electrical diagram.....41
- 19. Disposal42
- 20. Right of warranty.....42
- 21. Approvals and certificates43



1. Foreword

Congratulations on purchasing your new Raizer.

This is an original user manual for your new Raizer.



It is important to read this manual before using the Raizer.

The Raizer is a battery-powered mobile lifting chair which can be assembled around a fallen person and raises a fallen person up to an almost standing position in a few minutes. It can be operated by only a single assistant and requires no physical input from the assistant aside from a helping hand.

The Raizer is simple to operate by means of the control panel mounted on the side of the seat, or via a remote control*.



*Supplementary equipment

1.1 Quick Guide



There is a supplementary Quick Guide in the pocket of the carrying bag.

You can store this user manual in the same place.



Scan to retrieve an extra Quick Guide

2. Declaration

Corporate Office:

Liftup Inc.
4809 Ehrlich Road
Suite 105
FL – 33624, Tampa
Phone: +1 844 543 887
www.liftup.us

Manufacture:

Liftup A/S
Hagensvej 21
DK–9530 Stoevring
Denmark.
Phone: +45 9686 3020
www.liftup.dk

Copyright and Trademarks

© Liftup A/S. All rights reserved.

Liftup, the Liftup logo and Liftup are trademarks of Liftup A/S, registered in the United States and in other countries. All other trademarks are the property of their respective owners.

The following Product Limited Warranty gives Resellers specific legal rights. You may have others, which vary from state/jurisdiction to state/jurisdiction.

Product Limited Warranty

Subject to the terms and conditions set forth herein, Liftup A/S (“Liftup”) makes the following warranty only to its Resellers who purchase the RAIZER hardware product (“Product”) directly from Liftup: for a period of one (1) year from the date of shipment from Liftup, the Product will substantially conform to Liftup’s standard published specifications for the Product and the Product hardware will be substantially free from defects in materials and workmanship. The foregoing warranty shall not apply to embedded software/firmware components.

THIS PRODUCT LIMITED WARRANTY IS PROVIDED TO RESELLERS AND TO RESELLERS ONLY. RESELLER IS SOLELY RESPONSIBLE FOR ANY AND ALL WARRANTIES MADE TO ITS CUSTOMERS, AND LIFTUP MAKES NO WARRANTIES, EXPRESS OR IMPLIED, AND SHALL HAVE NO OBLIGATIONS OR LIABILITY TO RESELLER’S CUSTOMERS OR END-USERS OF THE PRODUCT. RESELLER SHALL NOT MAKE ANY REPRESENTATIONS OR WARRANTIES ON LIFTUP’S BEHALF, AND SHALL FULLY INDEMNIFY, DEFEND AND HOLD LIFTUP HARMLESS FROM ANY BREACH OF THE FOREGOING. IF RESELLER DISTRIBUTES PRODUCT TO END-USER CUSTOMERS, RESELLER SHALL BE SOLELY RESPONSIBLE FOR PREPARING AND PROVIDING PRODUCT WARRANTIES AND PRODUCT LITERATURE TO END-USERS.

Warranty Remedies

If the Product fails during the warranty period for reasons covered by this Product Limited Warranty and Reseller notifies Liftup of such failure during the warranty period, Liftup at its option will repair OR replace the nonconforming Product, OR refund the purchase price paid by Reseller for the Product, provided that Reseller returns the Product to Liftup in accordance with Liftup’s standard return material authorization procedures or as otherwise instructed by Liftup.

Warranty Exclusions and Disclaimers

The foregoing Product Limited Warranty shall only apply in the event and to the extent that (i) the Product is properly and correctly installed, configured, interfaced, maintained, stored and operated in accordance with Liftup’s specifications, and (ii) the Product is not modified or misused. This Product Limited Warranty shall not apply to, and Liftup shall not be responsible for, defects or performance problems resulting from: (a) the combination or utilization of the Product with hardware or software products, information, data, systems, interfaces, services or devices not made, supplied or specified by Liftup; (b) the operation of the Product under any specifications other than, or in addition to, Liftup’s standard published specifications for the Product; (c) the unauthorized installation, modification or use of the Product; (d) damage caused by: accident, lightning or other electrical discharge, water immersion or spray, or exposure to environmental conditions for which the Product is not intended; or (e) normal wear and tear on consumable parts, including by way of example and without limitation, batteries.

LIFTUP DOES NOT WARRANT OR GUARANTEE THE RESULTS OBTAINED THROUGH THE USE OF THE PRODUCT. THE FOREGOING TERMS OF THE PRODUCT LIMITED WARRANTY STATE LIFTUP’S ENTIRE LIABILITY, AND RESELLER’S EXCLUSIVE REMEDIES, RELATING TO THE USE AND PERFORMANCE OF THE PRODUCT EXCEPT AS OTHERWISE EXPRESSLY PROVIDED FOR IN THIS PRODUCT LIMITED WARRANTY, THE PRODUCT, ACCOMPANYING DOCUMENTATION AND MATERIALS, AND/OR ANY EMBEDDED SOFTWARE/FIRMWARE AND UPDATES THERETO ARE PROVIDED “AS-IS” AND WITHOUT EXPRESS OR IMPLIED WARRANTIES OF ANY KIND, BY EITHER LIFTUP OR ANYONE WHO HAS BEEN INVOLVED IN ITS CREATION, PRODUCTION, INSTALLATION OR DISTRIBUTION, INCLUDING, BUT NOT LIMITED TO, THE IMPLIED WARRANTIES OF MERCHANTABILITY AND FITNESS FOR A PARTICULAR PURPOSE, TITLE AND NONINFRINGEMENT. THE STATED EXPRESS WARRANTIES ARE IN LIEU OF ALL OBLIGATIONS OR LIABILITIES ON THE PART OF LIFTUP ARISING OUT OF, OR IN CONNECTION WITH, THE PRODUCT. WITHOUT LIMITING THE GENERALITY OF THE FOREGOING:

THE PRODUCT MAY CONTAIN TECHNOLOGY THAT IS NOT FAULT TOLERANT AND IS NOT DESIGNED, MANUFACTURED OR INTENDED FOR USE IN ENVIRONMENTS OR APPLICATIONS IN WHICH THE FAILURE OF THE PRODUCT WOULD LEAD TO DEATH, PERSONAL INJURY OR SEVERE PHYSICAL OR ENVIRONMENTAL DAMAGE OR SEVERE FINANCIAL LOSS. ANY USE OR DISTRIBUTION BY RESELLER OR ITS CUSTOMERS IN CONNECTION WITH ANY SUCH ENVIRONMENT OR APPLICATION SHALL BE AT RESELLER’S AND ITS CUSTOMERS’ SOLE RISK, AND LIFTUP SHALL HAVE NO LIABILITY WHATSOEVER IN CONNECTION THEREWITH. RESELLER SHALL INDEMNIFY AND HOLD LIFTUP AND ITS SUPPLIERS HARMLESS FROM ANY CLAIM BROUGHT AGAINST LIFTUP WHICH ARISES FROM RESELLER’S USE OR DISTRIBUTION OF THE PRODUCT IN CONNECTION WITH SUCH ENVIRONMENTS OR APPLICATIONS. SOME STATES AND JURISDICTIONS DO NOT ALLOW LIMITATIONS ON DURATION OR THE EXCLUSION OF AN IMPLIED WARRANTY, SO CERTAIN OF THE ABOVE LIMITATIONS MAY NOT APPLY TO EVERY RESELLER.

Embedded Software/Firmware

The Product and associated tools, if any, may contain embedded software/firmware, which is licensed, not sold, and is only for use within the Product as an integral part thereof. Such embedded software/firmware (which includes all updates thereto) contains valuable trade secrets and is proprietary to Liftup A/S and its suppliers. To the greatest extent permitted by law, such embedded software/firmware may not be modified, copied, disassembled, decompiled or reverse engineered. Liftup reserves all other rights.

Limitation of Liability

LIFTUP'S ENTIRE LIABILITY REGARDING THE PRODUCT SHALL BE LIMITED TO THE AMOUNT ACTUALLY PAID BY RESELLER FOR THE PRODUCT. TO THE MAXIMUM EXTENT PERMITTED BY APPLICABLE LAW, IN NO EVENT SHALL LIFTUP OR ITS SUPPLIERS BE LIABLE FOR ANY INDIRECT, SPECIAL, INCIDENTAL OR CONSEQUENTIAL DAMAGES WHATSOEVER UNDER ANY CIRCUMSTANCE OR LEGAL THEORY RELATING IN ANY WAY TO THE PRODUCTS, ACCOMPANYING DOCUMENTATION AND MATERIALS, AND ANY EMBEDDED SOFTWARE/FIRMWARE AND UPDATES THERETO (INCLUDING, WITHOUT LIMITATION, DAMAGES FOR LOSS OF BUSINESS PROFITS,

BUSINESS INTERRUPTION, LOSS OF DATA OR ANY OTHER PECUNIARY LOSS), REGARDLESS OF WHETHER LIFTUP HAS BEEN ADVISED OF THE POSSIBILITY OF ANY SUCH LOSS AND REGARDLESS OF THE COURSE OF DEALING BETWEEN LIFTUP AND RESELLER. BECAUSE SOME STATES AND JURISDICTIONS DO NOT ALLOW THE EXCLUSION OR LIMITATION OF LIABILITY FOR CONSEQUENTIAL OR INCIDENTAL DAMAGES, THE ABOVE LIMITATION MAY NOT APPLY TO EVERY RESELLER.

Notices

Class B Statement – Notice to Users. This equipment has been tested and found to comply with the limits for a Class B digital device, pursuant to Part 15 of the FCC rules. These limits are designed to provide reasonable protection against harmful interference in a residential installation. This equipment generates, uses, and can radiate radio frequency energy and, if not installed and used in accordance with the instructions, may cause harmful interference to radio communication. However, there is no guarantee that interference will not occur in a particular installation. If this equipment does cause harmful interference to radio or television reception, which can be determined by turning the equipment off and on, the user is encouraged to try to correct the interference by one or more of the following measures:

- Reorient or relocate the receiving antenna.
- Increase the separation between the equipment and the receiver.
- Consult the dealer or an experienced radio/TV technician for help.

Changes and modifications not expressly approved by the manufacturer or registrant of this equipment can void your authority to operate this equipment under Federal Communications Commission rules.

2.1 Regulatory Approvals

CE

The RAIZER product comply with the essential requirements of the RED Directive 2014/53/EU as stated by the EU Declaration of Conformity (CE). The RAIZER product comply

with the European Telecommunications Standards Institute Specifications EN 300 440 operating in 2.400 GHz to 2.483 GHz band for Radio Equipment and Systems).

EU/ International

The RAIZER complies with the essential requirements of the 2011/65/EU directive on the restriction of the use of certain hazardous substances in electrical and electronic equipment (ROHS 2).

Complies with the essential requirements of the EU 1907/2006 regulation concerning the Registration, Evaluation, Authorisation and Restriction of Chemicals (REACH).

Complies with the requirements of the 2002/96/EU directive on waste electrical and electronic equipment and directive 2006/66/EU on batteries and accumulators and waste batteries and accumulators (WEEE).

FCC/IC

The RAIZER and REMOTE products comply with the FCC Part 15.249 and the Industry Canada requirements RSS-GEN, RSS-210

The RAIZER and REMOTE products complies with Part 15 of the FCC rules and with Industry Canada license exempt standard(s). Operation is subject to the following two conditions:

- (1) This device may not cause harmful interference, and
- (2) This device must accept any interference received, including interference that may cause undesired operation.

The RAIZER and REMOTE products are SAR test excluded according to FCC KDB 447498, RSS102 and EN 62479 at separation distances larger than 5 mm and less than 50 mm.

With respect to radiofrequency radiation exposure Information, it is declared; that this equipment complies with FCC radiation exposure limits set forth for an uncontrolled environment. This gives an extra margin, since the remote control normally, only is used in “controlled environment” for approx. 30 seconds when lifting, and typically only a few times a day.

MIC (Japan)

The RAIZER product complies with the Japanese Ordinance concerning Technical Regulations Conformity Certification etc. of Specified Radio Equipment Article 2 clause (1) Item (19) Low Energy 2400-2483 MHz.

ACMA (AUS/NZ)

The RAIZER product complies with the Australian/New Zealand Radio communication Act 2400-2483 MHz.

RAIZER:

FCC ID: 2AK8H-RAIZER1

IC: 22516-RAIZER1

MIC Certification no.: [R] 202-LSF033

EU Declaration of Conformity:
(RED and Medical Device Directive)

Remote:

FCC ID: 2AK8H-REMOTE1

IC: 22516- REMOTE1

[R] 202-LSF034

CE



2.2 EU Declaration of conformity

Manufacturer: Liftup A/S
Address: Hagensvej 21, DK-9530 Støvring tel. +45 9686 3020
Reg. no. 523867 - Danish Medicines Agency
Hereby declares that: RAIZER® Battery operated mobile lifting chair is in compliance with

Medical Device Directive MDD 93/42/EEC. Medical devices under class 1 (according to rule 1 of annex IX of the Council Directive MDD 93/42/EEC).
 Conformity assessment was performed according to Annex VII. 2014/30/EU.
EMC Directive 2011/65/EU. substances in electronic equipment
ROHS-Directive: 2014/53/EU, Radio Equipment Directive.
RED CFR 47 Part 15 FCC ID: 2AK8H-RAIZER1
FCC (USA) RSS-210 IC: 22516-RAIZER1
ISED (Industry Canada) ARIB STD-T66 Low power systems. MIC no. [R] 202-LSF033
MIC (Japan)

Raizer meets the relevant requirements notably in following standards:

EN/ISO 10535:2006 Hoist for the transfer of disabled persons
 Confirmed by Danish Technological Institute, certificate no. 222
EN 12182:2012 Technical aids for disabled general requirements and test methods
EN 60601-1:2006+Corr-1,-2:2008 +AC, A1:2013 Safety of Medical Electrical Equipment
EN 60601-1-2: 2015 EMC of Medical Electrical Equipment
EN 60601-1-11:2015 Home Care
CISPR 11, Class B Emission
EN 61000-4-2:2009 ESD Electrostatic Discharges
EN 61000-4-3:2006+A1:2008+
IS1:2009+A2:2010 Radiated RF Immunity
EN 61000-4-8:2010 Magnetic Field
EN 62479:2010 Human exposure
EN 300 440, v2.1.1 Electromagnetic compatibility + Radio spectrum Matters
Draft EN 301489-1, v2.2.0 Electromagnetic compatibility + Radio spectrum Matters
Draft EN301489-17, v3.2.0 Electromagnetic compatibility + Radio spectrum Matters
AS/NZS 4268 Radio Equipment and Systems – Short Range devices
AS/NZS 2772.2 Radio Frequency Fields (mean power < 1 mW)

Testing and conformity assessment performed by Danish Technological Institute, Jens-EMC and Liftup A/S

The above products are manufactured under the following management system:

EN ISO 9001: 2008 Quality management, Certificate No. 44 100 117583
EN 14971: 2012 Application of risk management to medical devices

 Director
Title

 Flemming Eriksen
Name

 Liftup A/S, Hagensvej 21, DK-9530 Støvring
Company

 2016-09-15
Date

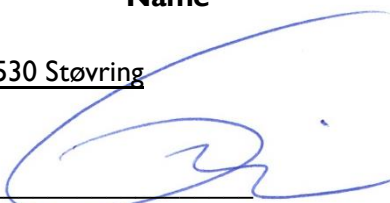
Signature



3. Type certificate

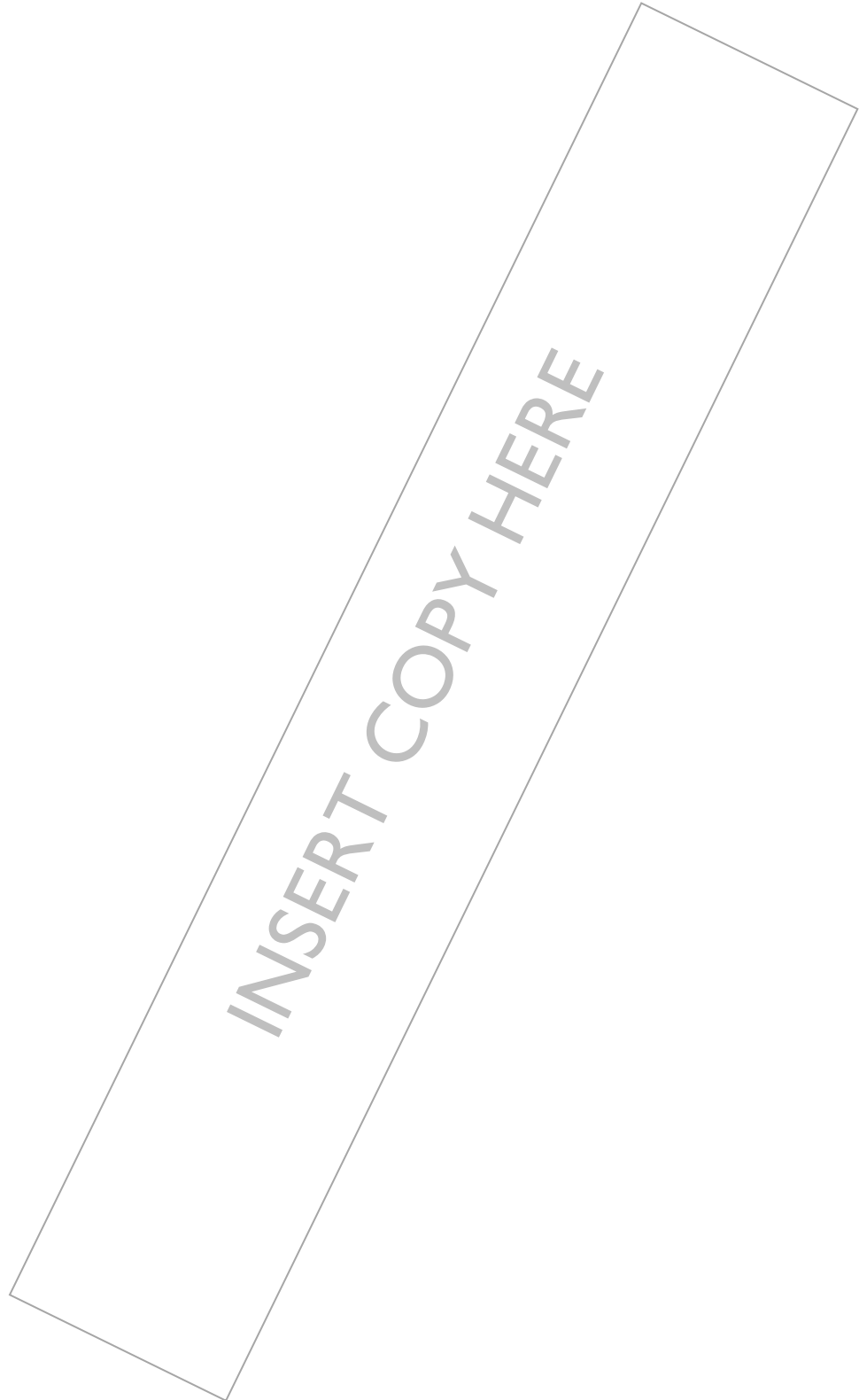

4. Intended use

The Raizer should only be used to bring a person lying on the floor to a seated or almost standing position, who cannot do so by themselves. The person may then require relocation from this position.

The max. load of the Raizer is 150kg (330.7 lbs) with max. 1 person at a time on the chair. The max. load is also stated on the CE-mark on the rear of the seat. The Raizer can be used approx. 40 times at full load on a full charge. A charger is included with your Raizer.



Read this user manual thoroughly before using the device.
The owner of the device is obliged to maintain it according to the maintenance guide in section 13.



Lifting capacity: Max. 150 kg (330.7 lbs)



Do not push or transport the lifting chair while the person is sitting in it



Do not stand on the lifting chair



Do not use this device in or around water – see 13.1.



Read the user manual thoroughly before using this device.



Fasten the seatbelt before performing a lift



Disconnect and remove the charger before use



Do not dispose of batteries or electrical or electronic equipment with unsorted household trash. When disposing of this device, ensure compliance with local ordinances and regulations.

5. Technical specifications

Example:

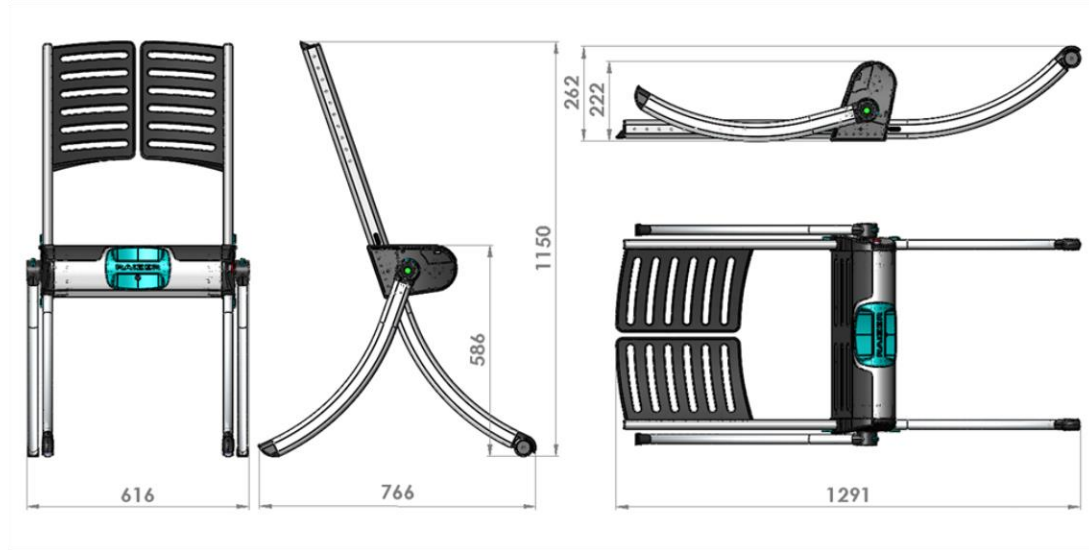

5.1 Raizer Lifting chair

Battery:	LiFePo4, 12V, 5AH
Number of lifts on a full charge:	40 with a max. load. Approx. 100 with an average load.
Duty Cycle:	1 min. / 5 min.
Charging time:	Max. 6 hours (230V charger)
Charging of depleted battery:	10–15 min = 1 lift
Dimensions (L x W x H):	Standing 766 x 616 x 1150 mm / 30 x 24 x 45 in. Lying 1291 x 616 x 262 mm / 51 x 24 x 10 in.
Weight:	Seat 9kg. (19,8 lbs.) + legs and back rest 4kg. (8,8 lbs.) – total 13kg. (28,6 lbs.)
Lifting capacity:	Max. 150kg. (330.7 lbs)
Lifting time:	20-30 secs.
Noise level:	< 70 dB A
Working temperature:	+5°C to +40°C/ 41°F to 104°F
Storage temperature:	-25°C to +70°C / 13°F to 158°F
Water and dust:	IP 42
Expected service life:	> 5 years
	Patented technology Registered design

Right reserved to make technical modifications

5.2 Remote control

2,4GHZ	Short Range devices. Receiver Class 3
Dimensions (L x W x H):	96 x 47 x 24mm / 3,79 x 1,85 x 0,95 in.
Weight:	48 g (0,11 lbs.)
Frequency's:	2,410GHz 2,435GHz and 2,460GHz
Power:	<0,6mW duty cycle < 1%
Battery:	3 Volt CR2032
Water and dust:	IP 42
Working temperature:	+5°C to +40°C/ 41°F to 104°F
Storage temperature:	-25°C to +70°C / 13°F to 158°F
Expected service life:	> 5 years

Right reserved to make technical modifications

5.3 Charger

Charger:	12V. 100-240V nom 90-264 VAC max
Power:	15W
Volt:	14,6V
Dimensions (L x W x H):	120 x 47 x 70mm / 4,8 x 1,85 x 2,75 in.
Weight:	170 g (0,38 lbs.)
Working temperature:	+5°C to +40°C/ 41°F to 104°F
Storage temperature:	-25°C to +70°C / 13°F to 158°F
Water and dust:	IP 4x
Expected service life:	> 5 years

Car adapter:	12 V car adapter
Volt:	13,8V nom. 14,6V max.

Right reserved to make technical modifications

6. Safety instructions

6.1 Assembly

Correct assembling of legs and back rest:

Incorrect assembling of legs and back rest:

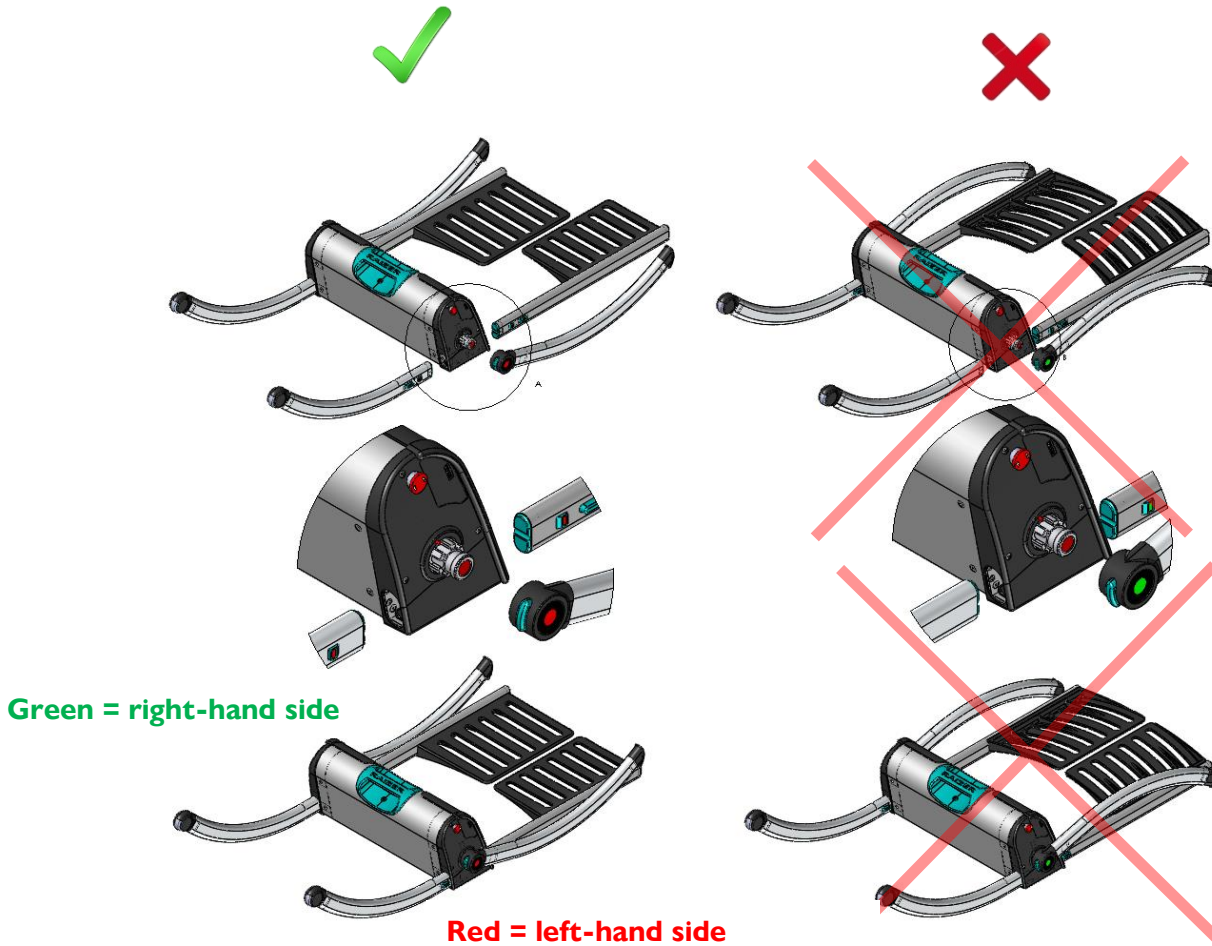

Observe **green** marks on right-hand side

Observe **red** marks on left-hand side

6.2 Avoiding personal injury.



Although the Raizer comes fitted with various safety features never use it if unintended persons or animals are close by, as there may otherwise be a risk of crushing. **Never allow children to play with the Raizer.**

6.3 Overload.

In order to avoid damage to the device in the event of overload (max. 150kg / 330.7 lbs), it is fitted with an overload cut out, which when triggered halts the lifting chair and issues an audible alarm. In the event of overload, run the chair down to the horizontal position/floor level.

With heavy loads on the Raizer, the chair may sink slowly if it is not in operation – this is completely normal. For safety reasons the Raizer is designed to sink slowly under heavy loads. This has been introduced in order to avoid mechanical breakage in the event of overload.

7. Personal safety



7.1 Avoiding personal injury

- To avoid personal injury it is NOT permitted to use the lifting chair when someone or something is at risk of being injured by crushing, cutting, falling, slipping, or similar.
- It is important that the assistant ensures that the chair can move without putting anyone or anything at risk.
- Be extra careful when there are children and physically or mentally challenged people on or near the chair, as these groups cannot always be expected to be able to foresee the possible consequences of its movements.
- Never load more on the chair than the 150kg (330.7 lbs) stated on the loading sign as the maximum load.
- DO NOT use the lifting chair until the person is secured with the seat-fitted seatbelt.

7.2 Seatbelt

- The seat is fitted with a seatbelt to secure the person using the chair.



DO NOT use the chair until this person is secured with the seatbelt around their hips.



*After assembly of the Raizer under the person on the floor,
fasten and click the seatbelt around the hips.*

7.3 Handling

The Raizer will normally be supplied by your dealer. The chair is ready for use upon delivery.

The Raizer can be transported in the 2 supplied bags. One is a case for the seat itself. The seat is carried by the turquoise handgrip.

The back rest and legs are carried in the bags using carrying straps for hand or back (long strap for shoulders, or two straps as a backpack).



DO NOT subject the Raizer to severe knocks or blows as this can affect product functionality.

Keep the accompanying remote control* dry and do not subject it to severe blows, such as by throwing it or dropping it, etc. Cleaning may only be done using a well-wrung cloth.



NEVER use a high-pressure jet or running water to rinse the chair, as this can damage the product.

*Supplementary equipment

8. Functionality

The Raizer is a battery-powered mobile lifting chair which raises a fallen person up to an almost standing position in 20-30 secs. It can be operated by only a single assistant and requires no physical effort from the assistant aside from a helping hand.

It works by the assistant assembling the Raizer around the fallen person and is operated by using the button panel on the seat or by means of the remote control*. The assistant can raise the fallen person to a sitting or almost standing position ready for relocation.

To use the Raizer, hold down the button for the entire lift. The lifting will stop if the button is released.

9. Prior to use



ENSURE that the Raizer is always fully charged. 2 chargers are supplied with the device, and we recommend that the Raizer always be charged and ready for use. You should check the Raizer for power at least once every 6 months and recharge if necessary. See also section 12.

Charging of depleted battery: 10–15 min = 1 lift

The Raizer can be stored wherever desired. However, lifting speed will be reduced if the battery temperature falls below 0°C/32°F. In practice, though, even if stored in a vehicle in a severe frost (-15°C/5°F), if charged, the Raizer will always be able to perform its task.

*Supplementary equipment

10. Operation

10.1 Assembly and use of the Raizer®

1

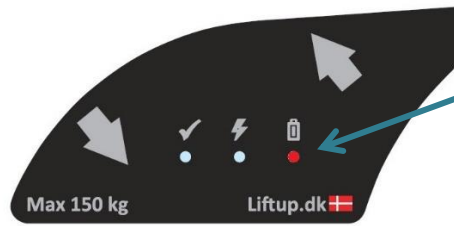

- Ensure that the Raizer is fully charged before use. To turn it on, press the up or down buttons on the side of the Raizer.
- A steady green LED indicates a fully-charged battery.

2



- Approach the fallen person

3

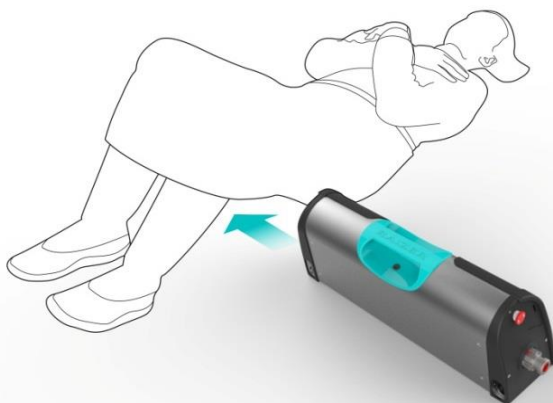

- Place the seat on the floor by the person's side.
- Lift the person's thighs to an angled position.
- Carefully push the seat in under the person's thighs.

10.2 Assembly of left-hand side

Items for assembly on the left-hand side are marked with a red circle.

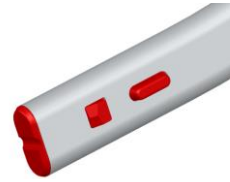

1

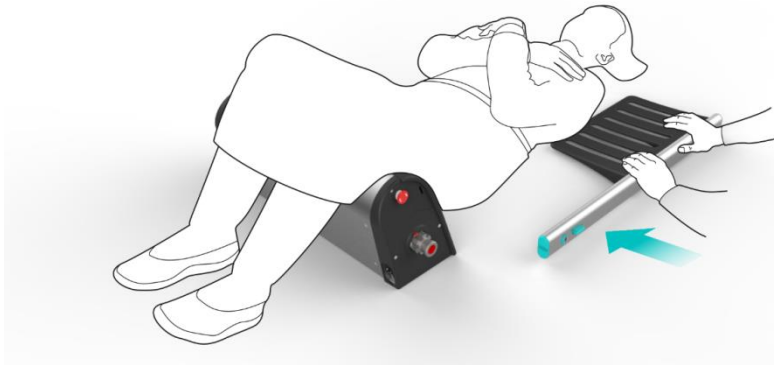

- Turn the person's shoulder by a careful push of the elbow.
- Carefully push the back rest (marked red for left-hand side) in under the person's shoulder.

2

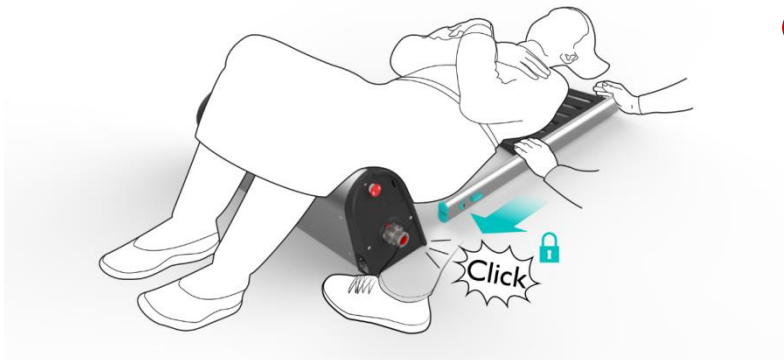

- Slide the back rest in and click into place in the seat.
- If necessary, place a foot in front of the seat to prevent it from moving forward.

3



- Push the rear leg (marked red for left-hand side) onto the shaft and click into place.

4



- Slide the front leg (marked red for left-hand side) into the seat and click it into in place.
- Note that the snap-lock is to face outwards.

10.3 Assembly of right-hand side

Items for assembly on the right-hand side are marked with a green circle.

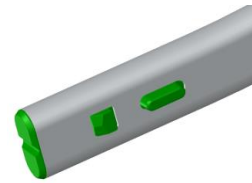

1

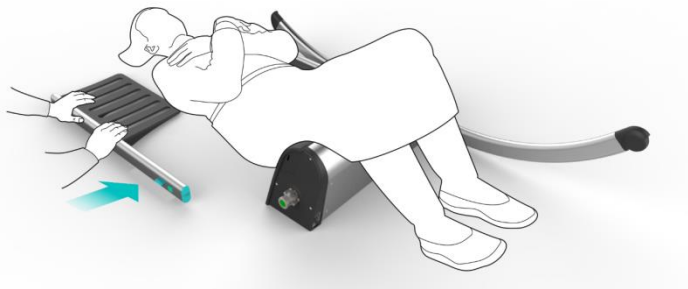

- Carefully turn the person's shoulder by a push of the elbow.
- Carefully push the back rest (marked green for right-hand side) in under the person's shoulder.

2



- Slide the back rest in and click into place in the seat.
- If necessary, place a foot in front of the seat to prevent it from moving forward.

3

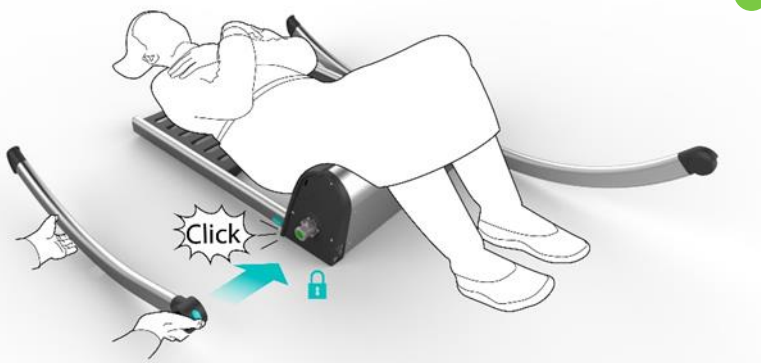

- Push the rear leg (marked green for right-hand side) onto the shaft and click into place.
- Note: right-hand and left-hand rear legs are mounted on the drive shaft so they are parallel, i.e. in the same position as the opposite side.

4

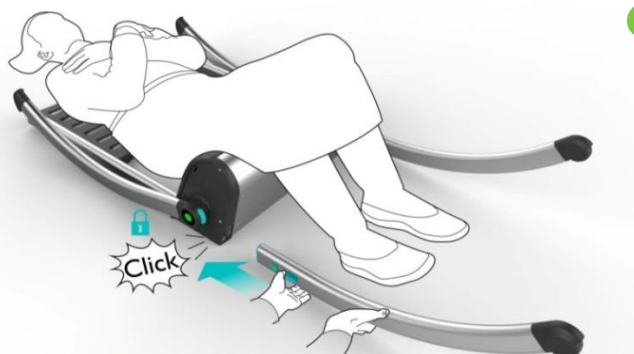

- Slide the front leg (marked green for right-hand side) into the seat and click it in place.
- Note that the snap-lock is to face outwards.



Only raise the chair when you are sure that the person’s feet, arms, hands or other body parts are not at risk of being struck or run over by the action of the chair!

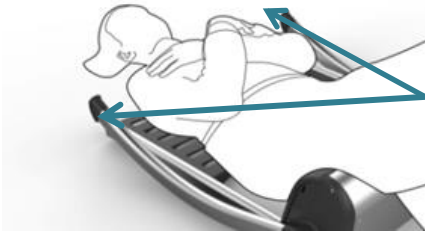

THE REAR LEGS

The rear legs are fitted horizontally and lie just above the floor along the shoulder (as in the illustration). Should this not be the case, be careful to fit both rear legs in parallel.



Be aware of the positioning of the shoulders and make sure that the arms are crossed upon the chest, due to the fact that the rear legs move down towards the floor as soon as the up button is pressed. This may put the person’s shoulders and arms at risk of injury if not positioned correctly.

If the legs are mounted in a higher position, pay attention to the rotating legs moving towards the floor. Make sure no body parts or clothes are at risk of being struck of the rotating legs.

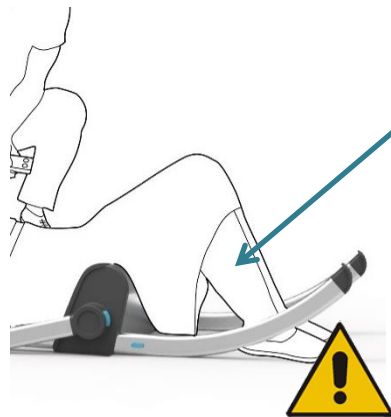

THE FRONT LEGS

Ensure that the person’s legs are together and their feet/legs are not at risk of getting in under a front leg when the chair is raised, as the front legs move toward the floor before the chair begins to lift its user.

10.4 Lifting of person

1

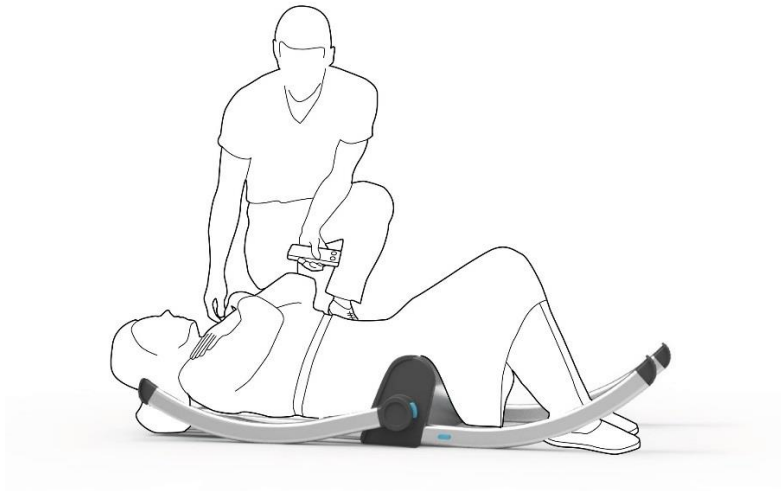

- After assembly of the Raizer under the fallen person, wrap and click the seatbelt around their hips.
- The Raizer is now ready to lift the user.

2



- Support the person's neck with one hand.
- Press the "up arrow" on the side panel or remote control* 
- The Raizer can be operated from either side.

3



- Keep pressing the “up arrow” until the person is in the required position.



4



- The Raizer will automatically stop when the person is in a sitting position.
- The Raizer is prevented from moving too far up and will stop automatically in the top position, whereupon a long beep will be emitted.

5



- Run the Raizer into a horizontal position and disassemble to ensure easier assemble for next lift/use.
- This also to prevent unnecessary strain on the helper’s back.

10.5 Operation of the Raizer® by means of seat buttons

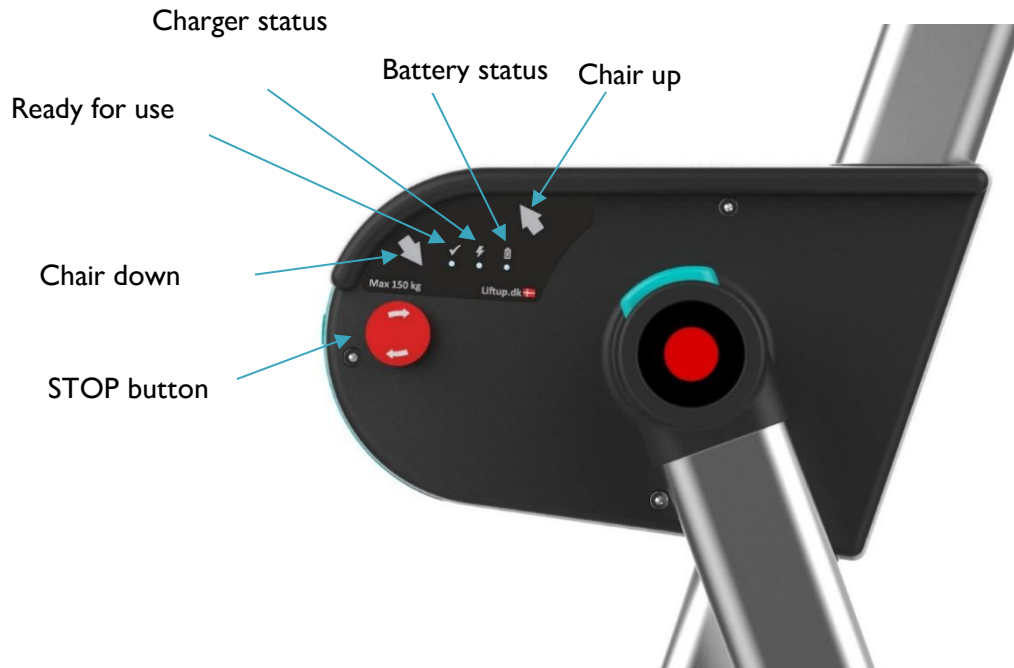

1

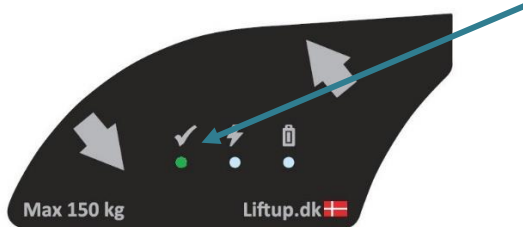

- The rotating legs must be fitted correctly before the Raizer can operate (see items 10.2 and 10.3 of section 10).
- The green LED will be lit when the device is ready for use.
- Operate the Raizer with a continuous press of the “up arrow” or “down arrow” buttons.
- The Raizer will switch off automatically after not being used for 10 minutes (it will emit a long beep before powering down).
- Operate the Raizer by continuously pressing one of up/down arrows on the side of the chair.

2

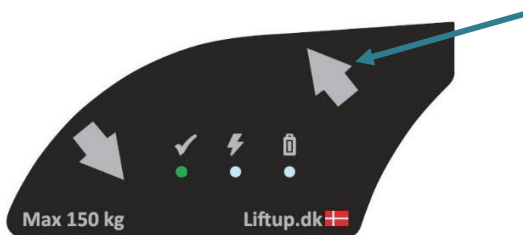

- Press here to drive the lifting chair upwards.
- It will only run for as long as the button is pressed.

3

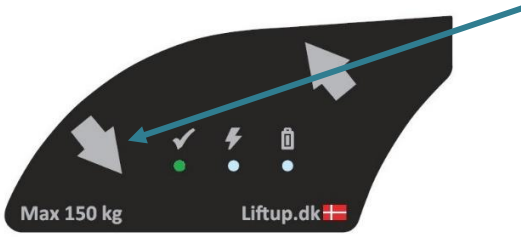

- Press here to drive the Raizer downwards.
- It will only run for as long as the button is pressed.

4



- Press the stop button to deactivate the Raizer. All movement functions will be turned off.
- Turn the stop button in the direction of the arrows to reactivate the device.

5

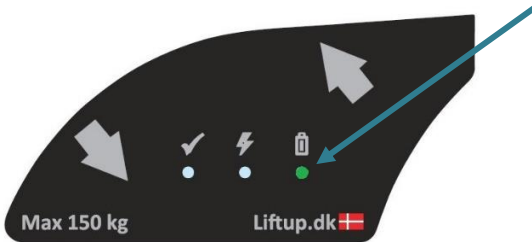

- The LED will be lit green when the device is more than 20% charged up.
- **Attention:** During operation with a load the LED can change to red – this is normal.

6

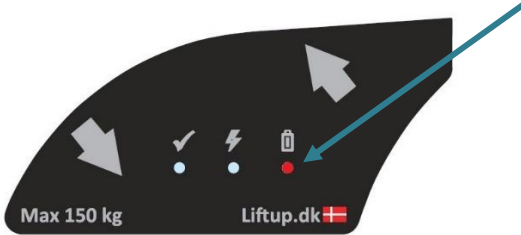

- The LED will be lit red to indicate a battery capacity of below 10%.
- In this state there is a max. of 0-5 lifts left in the battery. You will/need to charge the Raizer (see section 12, Charging).

10.6 Operation of the Raizer® by means of remote control*

1



- Press here to drive the chair upwards.
- It will only run for as long as the button is pressed.
- **Attention:** In order to operate the remote control the up/down button on the Raizer has to be pressed (by a light press of the up/down arrows on the side of the chair)

2



- Press here to drive the chair downwards.
- It will only run for as long as the button is pressed.

Attention: There might be a small delay before the Raizer starts driving.

*Supplementary equipment

10.7 How to pair the remote control transmitter and receiver

How to reset transmitter and receiver:

To reset a remote control* so it is no longer associated with the Raizer, do as follows:

1. Press the UP (↑) and DOWN (↓) buttons on the remote control* at the same time and hold them down for approx. 5 seconds until the control LED on the remote control* begins to flash slowly. The remote control is now in installation mode for 2 minutes.
2. Perform the following within the 2 minutes:

Press: UP(↑), UP(↑), DOWN(↓), DOWN(↓), UP(↑), DOWN(↓), UP(↑), DOWN(↓)

When the control LED starts to flash quickly, the remote control* is no longer associated with the Raizer.

Pairing of extra remote control*

1. Ensure that there is power to the Raizer.

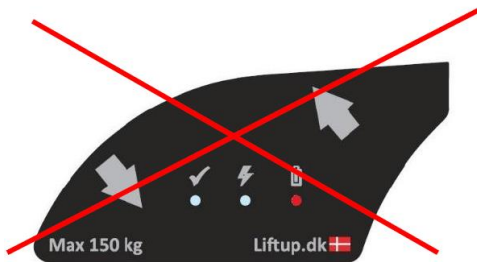

2. The Raizer must be switched off
The device will switch off automatically after 10 minutes without use (it will emit a long beep before powering down).
3. Press the UP (↑) and DOWN (↓) buttons on the remote control* at the same time and hold them down for approx. 5 seconds until the control LED on the remote control* begins to flash slowly. The remote control* is now in installation mode for 2 minutes.
4. Within these 2 minutes, switch on the lifting chair you require associated with the remote control* by pressing the up/down arrows simultaneously on the side of the chair.
5. The control LED on the remote control* is associated with the lifting chair when it stops flashing.
6. Test the system so as to ensure the pairing has been performed correctly; if not, repeat 1-5 above.

*Supplementary equipment

11. Disassembly

1



- Run the Raizer into a horizontal position and disassemble to ensure easier assemble for next lift/use.
- This also to prevent unnecessary strain on the helper's back.

2



- Put all parts into the carrying bags.

12. Charging of the Raizer®

1

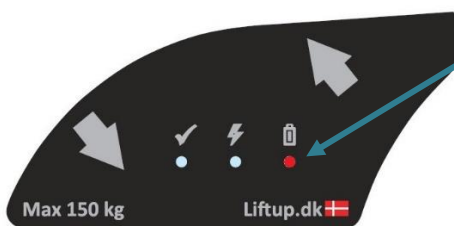

- The LED will be lit red to indicate a battery capacity of below 10%.
- **Attention:** This will only light when the chair is powered on.

2

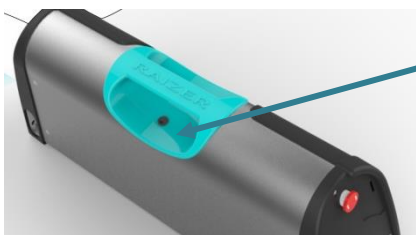

- The charger socket is located below the handgrip of the seat.

3



- Connect the charger to the socket on the Raizer

4



- Or connect the 12 VDC adapter to the socket on the Raizer

5

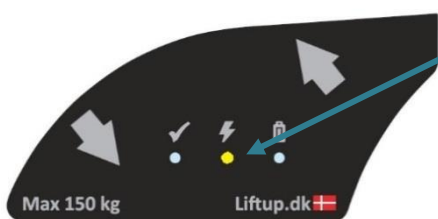

- The LED will be lit yellow to indicate charging.

6

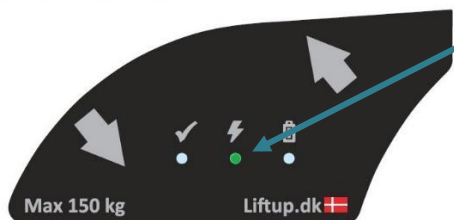

- A green LED indicates a fully-charged battery.

13. Maintenance

13.1 Cleaning:

The Raizer is not water-proof.

Attention: General cleaning may only be done using a well-wrung cloth.

You can disinfect your Raizer by using alcohol-based disinfectants at a concentration of 70–85 v/v%.



DO NOT use running water, a high-pressure jet or a hose directly on the Raizer.



13.2 Mechanical maintenance

The mechanical maintenance of the Raizer shall normally only be undertaken in connection with the regular annual service inspection. This is to be undertaken by a qualified service technician in accordance with the checklist in section 14.

Should unexpected errors or unusual sounds occur, contact your dealer at once:
<https://www.liftup.dk/en/distributors/>

13.3 Remote control*

A CR2032 battery is installed in the remote control*.

Attention:: In order to ensure reliable function swap the batteries every 2nd year.

To swap the battery, do the following:

1. Loosen the screw (Torx TX 6) on the rear of the remote control
2. Remove the back panel
3. Swap the battery
4. Refit the back panel and test





DO NOT swallow coin cell battery. Keep batteries out of reach of small children. Should a child swallow a battery, consult a physician immediately.



DO NOT dispose of batteries or electrical or electronic equipment with unsorted household rubbish. When disposing of this device, ensure compliance with local ordinances and regulations.

*Supplementary equipment

14. Maintenance checklist

In addition to the general maintenance described in section 13, we recommend routine annual inspections performed by a qualified service technician. The dealer you have bought the Raizer from will offer this service, but if you wish to use another service provider, you as the owner of the Raizer is responsible for ensuring that the chosen service technician is suitably qualified to service the product.

For safety reasons it is very important that these inspections are maintained, since lacking or improperly performed inspections may result in personal injury.

All service inspections should be logged in the service log book - see section 15.

15. Service log book

Service log

This form shall be filled in after every inspection

Customer	
Address	
Zip code:	
Telephone No:	Serial no.:
Contact person:	Product type No:

No.	Date:	Remarks.	Signature
1			
2			
3			
4			
5			
6			
7			
8			
9			
10			
12			
13			
14			
15			
16			
17			
18			
19			
20			
21			





16. Spare parts

Attention: It is important to use only original spare parts. Replacement of parts may only be undertaken by a qualified service technician.

The use of non-original spare parts may void the right of warranty. Furthermore, product safety may be compromised, which may pose a risk to personal safety.

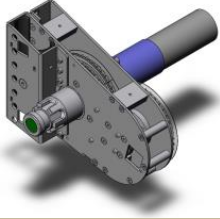
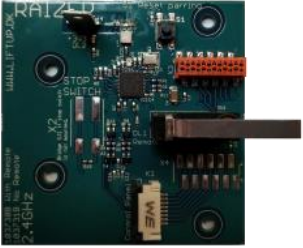
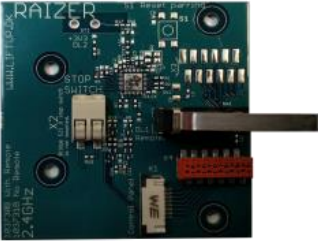
Part no.	Description	Photo/illustration
102962	Front leg complete, left-hand side / red (incl. wheel)	
102963	Front leg complete, right-hand side / green (incl. wheel)	
102964	Back rest complete, left-hand side, red	
102965	Back rest complete, right-hand side / green	
102966	Rear leg complete, left-hand side / red	
102967	Rear leg complete, right-hand side /green	
102971	Cover complete, Raizer	

Part no.	Description	Photo/illustration
103207	Handle complete, Raizer	
103210	Rear cover complete, Raizer	
102864	Connecting rod for drive units	
102885	Control Board, Raizer	
102890	Battery 12V 5Ah LiFePo4 Raizer	
102984	Side cover complete, left-hand side (stop button side)	
102985	Side cover complete, right-hand side	
102969	Motor unit, complete left-hand side / red	

Part no.	Description	Photo/illustration
102970	Motor unit, complete, right-hand side / green	
103730	Raizer side PCB with RF Receiver 2,4GHz	
103731	Raizer side PCB without RF Receiver 2,4GHz	
103270	Screw kit, Raizer	
102927	Color buttons, Raizer	
102980	Micromatch Cable 12 pol, for Raizer	
103421	Socket tool for Raizer	

Part no.	Description	Photo/illustration
102921	Battery charger 1205 SRP	
102641	Cigarette lighter plug with fuse for Raizer	
103978	Cigarette lighter extension cable for Raizer, 1,8m	
103728	Seatbelt for Raizer complete	
102956	Carry case for Raizer	
103933	Remote control – transmitter unit (Supplementary equipment)	
103311	Trolley, Raizer (Supplementary equipment)	

Part no.	Description	Photo/illustration
103314	Triple Wheel, 2pcs. Trolley, Raizer (Supplementary equipment)	
103313	Bike bracket kit, Trolley, Raizer (Supplementary equipment)	
103741	Disposable hygiene cover (10 pcs.) (Supplementary equipment)	
104195	Support belt for torso	

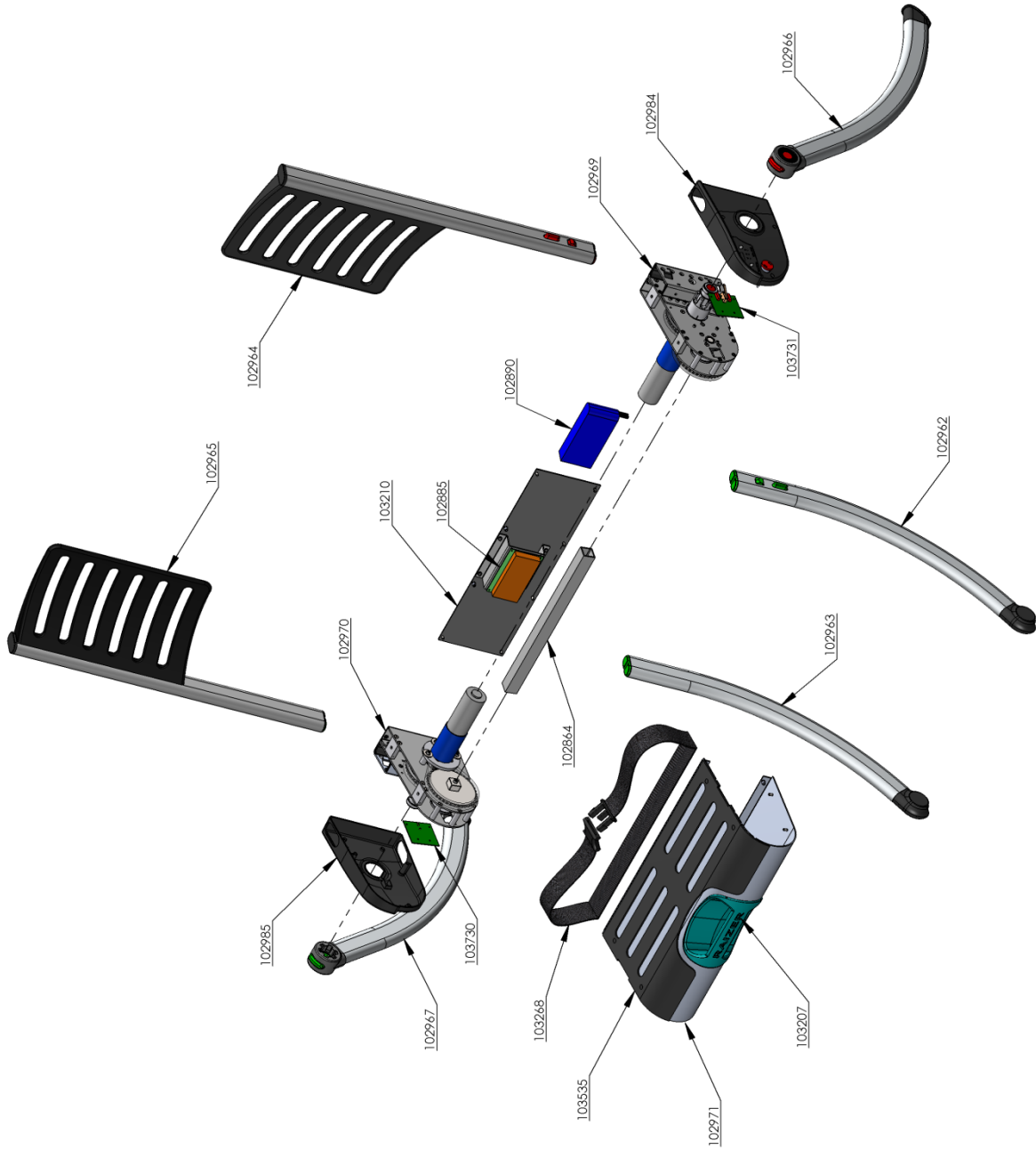

Raizer Art. No. 103724

17. Troubleshooting

Issue	Cause	Solution
The Raizer does not run, even if the up/down arrows are pressed.	The stop button is activated. 2-tone alarm.	Turn the stop button in the direction of the arrows and it will click out. See section 10.2. Check that the ready-for-service LED is lit green.
	The rear legs are not correctly fitted. 2-tone alarm.	Check that the ready-for-service LED is lit green. If not: Fit the rear legs so that they click completely into the shaft. See section 10.1.
	The Raizer is overloaded. 2-tone alarm.	Remove the load from the Raizer. See section 6.3.
	The battery is depleted. See LED	Charge the Raizer battery. See section 12.
The Raizer runs askew, when the up/down arrows are pressed.	The legs are not fitted in parallel.	Fit left and right rear legs so they are in parallel. See section 10.1.
The Raizer stops at the top position.	The chair has reached the top stop. Long beep.	Completely normal. The chair has reached its max. height.
Remote control* does not work	The Raizer is not powered on/activated	Briefly press the up or down buttons on the side of the device
	The remote control* is not correctly paired with the Raizer.	See section 10.7.

*Supplementary equipment

18. Electrical diagram

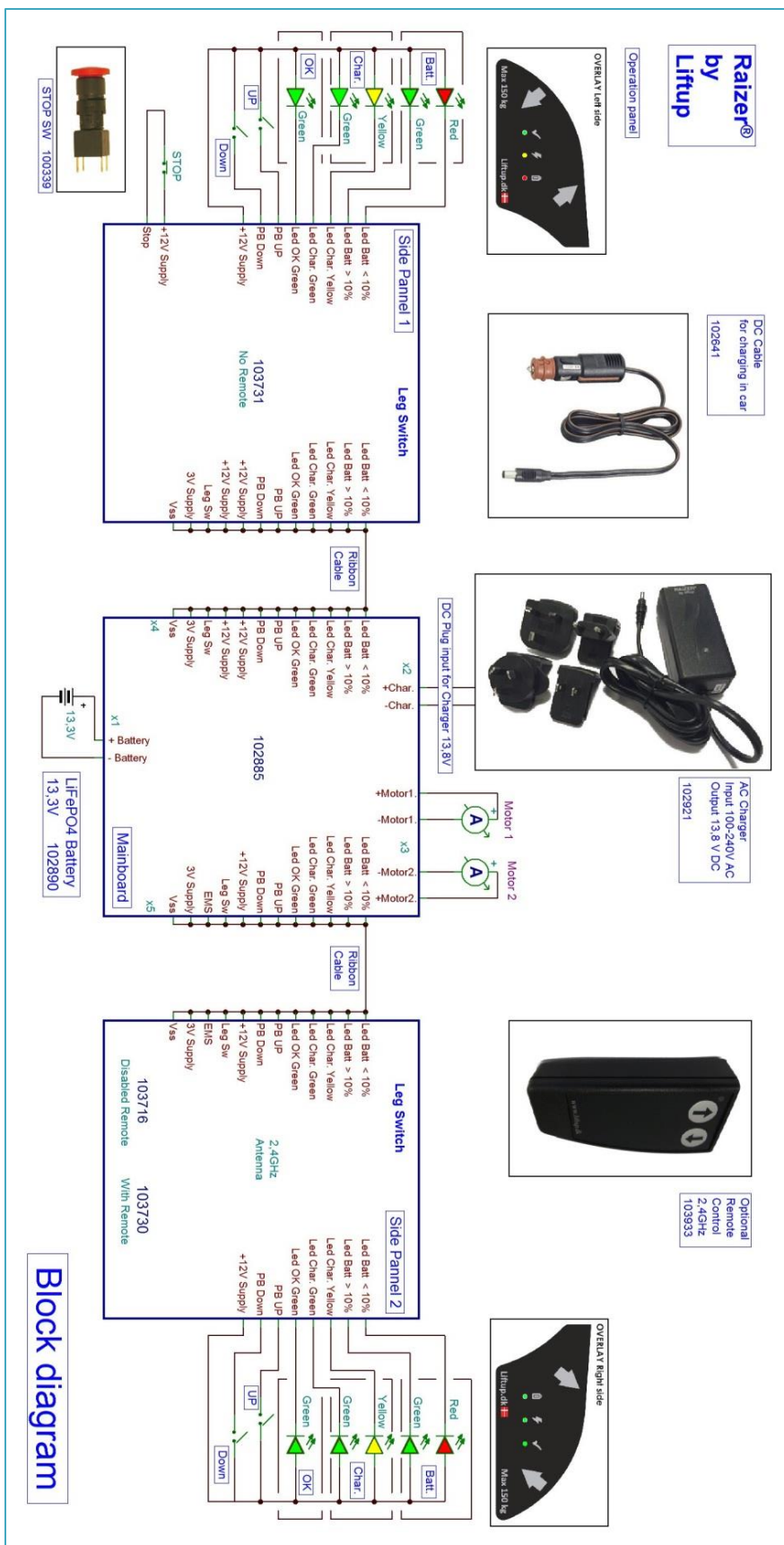

19. Disposal

It is the duty of the owner to dispose of the product in accordance with the regulations applicable at the time. Please note, in particular, that the control unit and remote control contain batteries, which must be disposed of separately.

Do not dispose of batteries or electrical or electronic equipment with unsorted household rubbish. When disposing of this device, ensure compliance with local ordinances and regulations.

Consider contacting your dealer for assistance with disposal.

20. Right of warranty

The right of warranty is subject to the General Conditions for Supply
https://www.liftup.dk/media/3179/general-conditions-for-supply_liftup-inc.pdf.

Attention: If the prescribed service inspections are not maintained the right of warranty may be lost.

Failing to perform these inspections can also have serious consequences for product safety. It rests with the customer to ensure compliance with the prescribed service inspections at all times. Cf. Danish Working Environment Authority Executive Order 1109 §14.

21. Approvals and certificates

The RAIZER product is tested in compliance with the European radio and medical specifications (CE - Declaration of Conformity) and certified according to the following radio recommendations (US/Canada and Japan respectively):

RAIZER:

 FCC-ID: 2AK8H-RAIZER1
IC: 22516-RAIZER1



REMOTE:

 FCC-ID: 2AK8H-REMOTE1
IC: 22516-REMOTE1



FCC and IC Statements

The RAIZER product contains radio transmitters that comply with CFR 47 Part 15.249 of the FCC rules and with RSS-GEN, RSS-102 and RSS-247 of Industry Canada requirements.

Notice statements according to CFR 47 Part 15.19 / RSS-GEN:

The RAIZER product complies with Part 15 of the FCC rules and with Industry Canada license exempt standard(s). Operation is subject to the following two conditions:

- (1) This device may not cause harmful interference, and
- (2) This device must accept any interference received, including interference that may cause undesired operation.

Déclarations selon le CFR 47 section 15.19 / RSS-GEN:

Le présent RAIZER appareil est conforme aux CNR d'Industrie Canada applicables aux appareils radio exempts de licence. L'exploitation est autorisée aux deux conditions suivantes:

- (1) l'appareil ne doit pas produire de brouillage, et
- (2) l'utilisateur de l'appareil doit accepter tout brouillage radioélectrique subi, même si le brouillage est susceptible d'en compromettre le fonctionnement.

NOTICE statements according to CFR 47 Part 15.21:

Changes or modifications made to this equipment not expressly approved by Liftup A/S may void the FCC authorization to operate this equipment.

Statements according to CFR 47 Part 2.1091 / 2.1093 and OET bulletin 65 / RSS-102:

The RAIZER and REMOTE products are SAR test excluded according to FCC KDB 447498, RSS102 and EN 62479 at separation distances larger than 5 mm and less than 50 mm with respect to the human body as the maximal radiated power is below the limits.

The RAIZER and REMOTE products are by declaration of RF Exposure Compliance for Exemption from Routine Evaluation Limits according to RSS102

ATTESTATION:

It is attested that the radio communication apparatus meets the exemption from the routine evaluation limits in RSS102 Section 2.5 of this standard; that the Technical Brief was prepared and the information contained therein is correct; that applicable measurement methods and evaluation methodologies have been followed; and that the device meets the SAR and/or RF field strength limits of RSS-102.

This transmitter must not be co-located or operating in conjunction with any other antenna or transmitter.

SAR test exclusion according to EN 62479

The RAIZER and REMOTE products are compliant according to EN 62479 as the output power is less than 20 mW.

AUS/NZ:

- The RAIZER complies with the AS/NZS 4268 requirements for 2.4 GHz transceiver.

Japan:

- The RAIZER complies with the requirements of the ordinance regulating Radio Equipment (2005-08), Art2. item 19 for 2.4 GHz applications with the use of ARIB STD-T66 for low power data communication systems.

Enjoy your new Raizer®

**Best regards,
Liftup Inc.**