

iP-XX96-10BD

10Gb/s CWDM SFP+ 10Km Transceiver

Product Features

- Up to 11.1Gbps Data Links
- Up to 10Km transmission on SMF
- Power dissipation < 1.5W
- Uncooled CWDM DFB Laser and PIN receiver
- Metal enclosure, for lower EMI
- 2-wire interface with integrated Digital Diagnostic monitoring
- Hot-pluggable SFP+ footprint
- Specifications compliant with SFF 8472
- Compliant with SFP+ MSA with LC connector
- Single 3.3V power supply
- Case operating temperature range:0°C to 70°C



Applications

- 10GBASE-LR/LW & 10G Ethernet

Standard

- Compliant to SFP+ SFF-8431
- Compliant to 802.3ae 10GBASE-LR/LW.
- RoHS Compliant.

Production Selection iP-XX96-10BD

Wavelength	xx	Clasp Color Code	Wavelength	xx	Clasp Color Code
1270nm	27	Gray	1370nm	37	Green
1290nm	29	Gray	1390nm	39	Yellow
1310nm	31	Gray	1410nm	41	Orange
1330nm	33	Purple	1430nm	43	Red
1350nm	35	Blue	1450nm	45	Brown

Absolute Maximum Ratings

Parameter	Symbol	Min	Typ	Max	Unit	Note
Storage Temperature	Ts	-40	-	85	°C	
Storage Ambient Humidity	HA	5	-	95	%	
Operating Relative Humidity	RH	-	-	85	%	
Power Supply Voltage	VCC	-0.3	-	4	V	
Signal Input Voltage		Vcc-0.3	-	Vcc+0.3	V	

Recommended Operating Conditions

Parameter	Symbol	Min	Typ	Max	Unit	Note	
Case Operating Temperature	Tcase	0	-	70	°C	Without air flow	
Power Supply Voltage	VCC	3.14	3.3	3.47	V		
Power Supply Current	ICC	-		450	mA		
Data Rate	BR		10.3125		Gbps		
Transmission Distance	TD		-	10	Km		
Coupled fiber		Single mode fiber					9/125um SMF

Optical Characteristics

Parameter	Symbol	Min	Typ	Max	Unit	Ref.
Transmitter						
Output Opt. Pwr	POUT	-6		-0.5	dBm	1
Optical Wavelength	λ	$\lambda-6.5$		$\lambda+6.5$	nm	
Optical Extinction Ratio	ER	3.5			dB	
RIN	RIN			-128	dB/Hz	
Output Eye Mask	Compliant with IEEE 802.3ae					
Receiver						
Rx Sensitivity	RSENS			-14.4	dBm	2
Input Saturation Power (Overload)	Psat	0.5			dBm	
Wavelength Range	λ	1270		1610	nm	
LOS De -Assert	LOSD			-17	dBm	
LOS Assert	LOSA	-30			dBm	
LOS Hysteresis		0.5			dB	

Notes:

- Class 1 Laser Safety per FDA/CDRH and IEC-825-1 regulations.
- Measured with a PRBS 231-1 test pattern, @10.325Gb/s, BER<10-12 .

Electrical Characteristics

Parameter	Symbol	Min	Typ	Max	Unit	Note
Supply Voltage	Vcc	3.14	3.3	3.46	V	
Supply Current	Icc			450	mA	
Transmitter						
Input differential impedance	Rin		100		Ω	1
Single ended data input swing	Vin,pp	180		1200	mV	
Transmit Disable Voltage	VD	Vcc-1.3		Vcc	V	
Transmit Enable Voltage	VEN	Vee		Vee+ 0.8	V	2
Transmit Disable Assert Time				10	us	
Receiver						
Differential data output swing	Vout,pp	300		850	mV	3
Data output rise time	tr	30			ps	4
Data output fall time	tf	30			ps	4
LOS Fault	VLOS fault	Vcc-1.3		VccHOST	V	5
LOS Normal	VLOS norm	Vee		Vee+0.8	V	5
Power Supply Rejection	PSR	100			mVpp	6

Notes:

1. Connected directly to TX data input pins. AC coupled thereafter.
2. Or open circuit.
3. Into 100 ohms differential termination.
4. These are unfiltered 20-80% values
5. Loss Of Signal is LVTTTL. Logic 0 indicates normal operation; logic 1 indicates no signal detected.
6. Receiver sensitivity is compliant with power supply sinusoidal modulation of 20 Hz to 1.5 MHz up to specified value applied through the recommended power supply filtering network.

Pin Descriptions

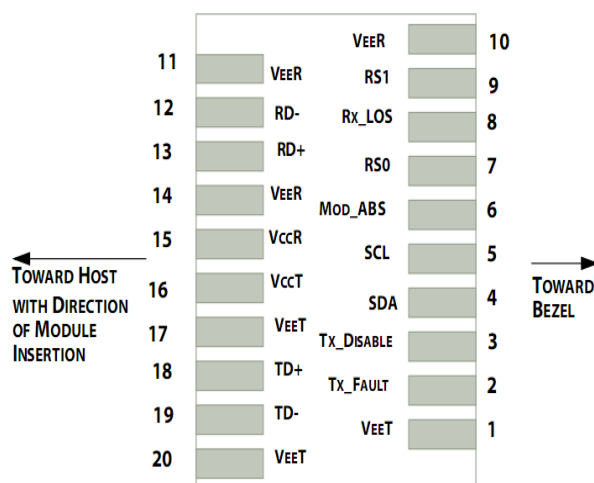

Pin out of Connector Block on Host Board

Pin	Symbol	Name/Description	Note
1	VEET	Transmitter Ground (Common with Receiver Ground)	1
2	TFAULT	Transmitter Fault.	2
3	TDIS	Transmitter Disable. Laser output disabled on high or open.	3
4	SDA	2-wire Serial Interface Data Line	4

5	SCL	2-wire Serial Interface Clock Line	4
6	MOD_ABS	Module Absent. Grounded within the module	4
7	RS0	Rate Select 0	5
8	LOS	Loss of Signal indication. Logic 0 indicates normal operation.	6
9	RS1	No connection required	1
10	VEER	Receiver Ground (Common with Transmitter Ground)	1
11	VEER	Receiver Ground (Common with Transmitter Ground)	1
12	RD-	Receiver Inverted DATA out. AC Coupled	
13	RD+	Receiver Non-inverted DATA out. AC Coupled	
14	VEER	Receiver Ground (Common with Transmitter Ground)	1
15	VCCR	Receiver Power Supply	
16	VCCT	Transmitter Power Supply	
17	VEET	Transmitter Ground (Common with Receiver Ground)	1
18	TD+	Transmitter Non-Inverted DATA in. AC Coupled.	
19	TD-	Transmitter Inverted DATA in. AC Coupled.	
20	VEET	Transmitter Ground (Common with Receiver Ground)	1

Notes:

1. Circuit ground is internally isolated from chassis ground.
2. TFAULT is an open collector/drain output, which should be pulled up with a 4.7kΩ– 10 kΩ resistor on the host board if intended for use. Pull up voltage should be between 2.0V to Vcc + 0.3V. A high output indicates a transmitter fault caused by either the TX bias current or the TX output power exceeding the preset alarm thresholds. A low output indicates normal operation. In the low state, the output is pulled to <0.8V.
3. Laser output disabled on TDIS >2.0V or open, enabled on TDIS <0.8V.
4. Should be pulled up with 4.7kΩ- 10kΩ on host board to a voltage between 2.0V and 3.6V. MOD_ABS pulls line low to indicate module is plugged in.
5. Internally pulled down per SFF-8431 Rev 4.1.
6. LOS is open collector output. It should be pulled up with 4.7kΩ – 10kΩ on host board to a voltage between 2.0V and 3.6V. Logic 0 indicates normal operation; logic 1 indicates loss of signal.

Digital Diagnostic Functions

Xmethod Network iP-XX96-10BD transceivers support the 2-wire serial communication protocol as defined in the SFP+ MSA. The standard SFP serial ID provides access to identification information that describes the transceiver's capabilities, standard interfaces, manufacturer, and other information.

Additionally, Xmethod Network SFP+ transceivers provide a unique enhanced digital diagnostic monitoring interface, which allows real-time access to device operating parameters such as transceiver temperature, laser bias current, transmitted optical power, received optical power and transceiver supply voltage. It also defines a sophisticated system of alarm and warning flags, which alerts end-users when particular operating parameters are outside of a factory set normal range.

The SFP+ MSA defines a 256-byte memory map in EEPROM that is accessible over a 2-wire serial interface at the 8 bit address 1010000X (A0h). The digital diagnostic monitoring interface makes use of the 8 bit address 1010001X (A2h), so the originally defined serial ID memory map remains unchanged.

The operating and diagnostics information is monitored and reported by a Digital Diagnostics Transceiver Controller (DDTC) inside the transceiver, which is accessed through a 2-wire serial interface. When the serial protocol is activated, the serial clock signal

(SCL, Mod Def 1) is generated by the host. The positive edge clocks data into the SFP transceiver into those segments of the E2PROM that are not write-protected. The negative edge clocks data from the SFP transceiver. The serial data signal (SDA, Mod Def 2) is bi-directional for serial data transfer. The host uses SDA in conjunction with SCL to mark the start and end of serial protocol activation. The memories are organized as a series of 8-bit data words that can be addressed individually or sequentially.

Host - Transceiver Interface Block Diagram

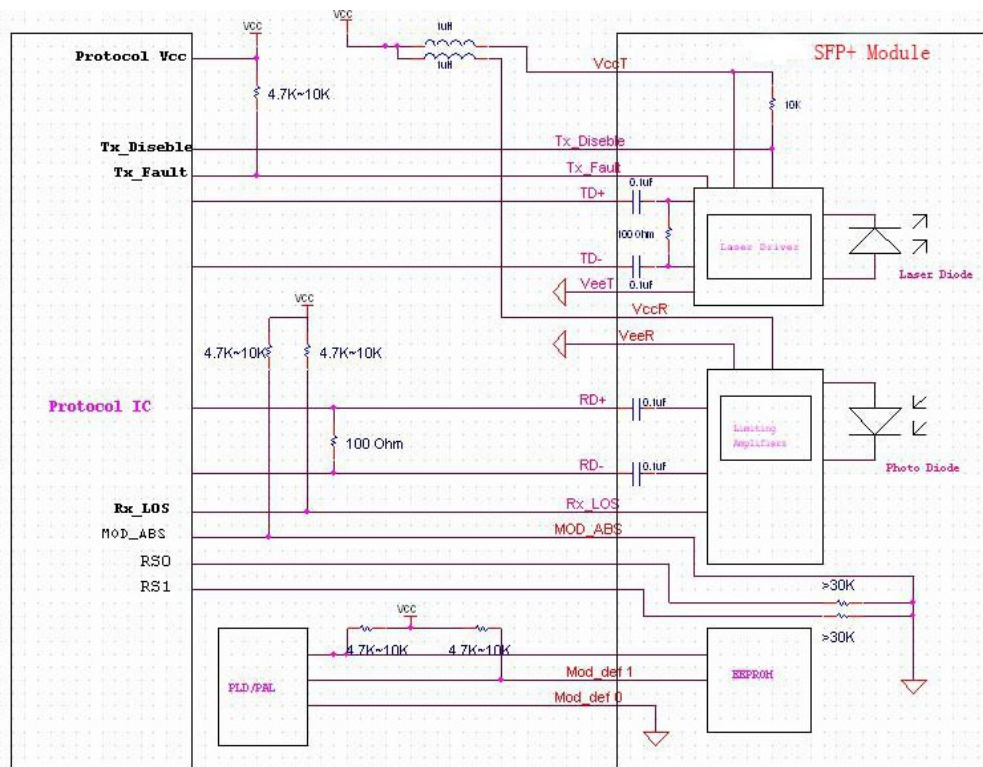

Outline Dimensions

Comply to SFF-8432 rev5.0, the improved Pluggable form factor specification.

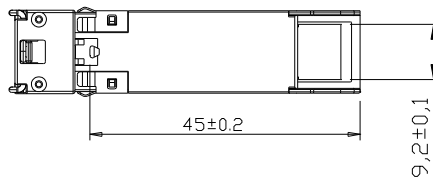
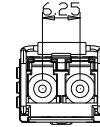
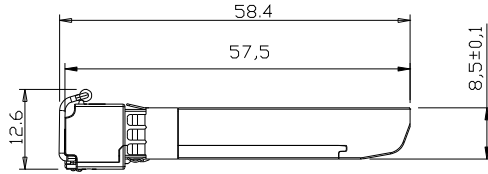
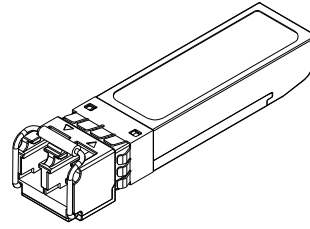
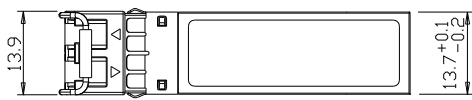

Units in mm

Regulatory Compliance

Feature	Reference	Performance
Electrostatic discharge (ESD)	IEC/EN 61000-4-2	Compatible with standards
Electromagnetic Interference (EMI)	FCC Part 15 Class B EN 55022 Class B (CISPR 22A)	Compatible with standards
Laser Eye Safety	FDA 21CFR 1040.10, 1040.11 IEC/EN 60825-1, 2	Class 1 laser product
Component Recognition	IEC/EN 60950, UL	Compatible with standards
ROHS	2002/95/EC	Compatible with standards
EMC	EN61000-3	Compatible with standards

Revision History

Revision	Notes	Authors	Checked	Approval	Date
Rev A0	New release	Granger Leung			2014.09.19