



PRICELIST

1/1 – 6/30/2021

Table of Contents

Miller Range.....	3
Starter Kits Cutting Kits Cleaning Kits.....	8
Cleaning Chains.....	13
Special Cleaning Tools.....	36
Twister Concrete & Liner Removers.....	42
Picote Brush Coating™.....	45
CIPP Lining Tools.....	54
Connection Collars Bladders.....	67
Twister Lateral Cutters.....	69
Special Drill Heads & Tiger Bores.....	73
Smart Cutter™.....	78
Pipe Cutter.....	89
Grabbers.....	92
Front Panels Drill Heads.....	96
Shaft Sleeves Shaft Connectors.....	104
Miller Spare Parts.....	107
Mini Cleaner Tools.....	111
Maxi Power+ Tools.....	117
Picote Robot Tools for Schwalm Robots.....	132
Additional Tools.....	135

Follow us on



MULTI-USE MACHINES FOR A RANGE OF CHALLENGES*

- **High-Speed Cleaning:** 500 to 2900rpm*
- **Lateral CIPP Reinstatements**
- **Unblocking Pipes**
 - Fats, Oils, and Grease
 - Wet Wipes and Diapers
- **Remove:**
 - Roots
 - Tuberculation and Scale
 - Concrete, Grout and Slurry
 - Failed CIPP Liners, Wrinkles, Fins and Resin Slugs
 - Displaced Joints & Intruding Connections
- **P-Traps and Multiple Bends**
- **Picote Brush Coating™** by adding a Mini/Maxi Coating Pump*

*Depending on model



SAFETY & TESTING

Our machines are designed with operator safety in mind. The flexible shaft rotates inside a protective casing which makes it safe to hold. All Millers are also fitted with a safety clutch, a shielded operator presence foot control and an emergency stop button. Before leaving Picote, ALL Millers undergo rigorous testing to ensure they meet our high quality standards.

MILLER RANGE

Mini Cleaner | Mini Cleaner +C | Battery Mini Cleaner | Battery Mini Cleaner +C | Mini Miller | Mini Miller +C | Battery Mini Miller | Battery Mini Miller +C | Super Midi Miller | Maxi Miller | Maxi Plus Miller | Maxi Miller Power+

NEW +C MILLERS WITH INTEGRATED CAMERA

The Picote Mini Miller +C and Mini Cleaner +C units feature an integrated 98ft color camera that makes viewing of cleaning and cutting jobs easier and makes Picote Brush Coating™ setup simpler.



Mini Cleaner

\$3,997.00



3540000816US (Cleaning Package) 3540000818US (Cutting Package)
1/3" Shaft with Flexible Outer Casing
High Speed Cleaning 1¼"-3", Cutting 1¼"-3" & Brush Coating 1¼"-3"
Max Range: 50ft (no extension).
Weight: 59lbs. 500-2900rpm.

Designed with plumbers in mind. Cleaning, descaling, roots, cutting, & coating in small pipes is now easier than ever before. Standard safety features: protective outer shaft casing, operator presence foot control, mechanical safety clutch, in-line GFI, & an E-stop.

Mini Miller

\$4,141.00



3540000817US
1/3" Shaft with Thick Outer Casing
High Speed Cleaning 2-4" & Cutting 2-3" & Brush Coating 2-6"
Range: 50ft. Max Range: 82ft with extension.
Weight: 59lbs. 500-2900rpm.
Can be extended 32ft (1312030085010 Shaft 1/3" Thick 32ft).

Lightweight & compact while still covering a large application range. Standard safety features: mechanical safety clutch, in-line GFI, operator presence foot control, protective outer shaft casing, & E-stop.

Super Midi 3/8" Shaft

\$ 7,447.00



3551031000US
3/8" Shaft with Thin Outer Casing
High Speed Cleaning 2-6", Cutting 2-6" & Brush Coating 3-8"
Range: 75ft Max Range: 107ft with extension.
Weight: 143lbs. 500-1500rpm.
Can be extended 32ft (Extension: 1312020105010 Shaft 3/8" 32ft)

Offers the strength and flexibility of 3/8" shaft. Use even in 2" pipes! It is fed by a standard wall outlet making it easy to use on almost any jobsite. Standard safety features: protective outer shaft casing, operator presence foot control, electric safety clutch, and an E-stop.

Super Midi

\$ 7,447.00



3551031220US
1/2" Shaft with Thin Outer Casing
High Speed Cleaning 3-6", Cutting 3-6" & Brush Coating 3-8"
Range: 65ft Max Range: 97ft with extension.
Weight: 150lbs. 500-1500rpm.
Can be extended 32ft (Extension: 1312020125010 Shaft 1/2" 32ft)

Offers the added strength of the 1/2" shaft with a weight of only 150lbs. It is fed by a standard wall outlet making it easy to use on almost any jobsite. Standard safety features: protective outer shaft casing, operator presence foot control, electric safety clutch, and an E-stop.



Maxi Miller

\$ 10,985.00

3560032012US

1/2" Shaft with Thick Outer Casing. **Requires a 30 Amp Non-GFI Generator/Outlet**
 High Speed Cleaning 3-10", Cutting 3-8" & Brush Coating 3-12"
 Range: 100ft. Max Range: 132ft with extension.
 Weight: 196lbs. 500-1475rpm.
 Can be extended 32ft (Extension: 1312020125010 Shaft 1/2" 32ft)

Opens the door for new jobs such as blockage and root removal, light and heavy descaling, reinstating lines in CIPP, epoxy brush coating, liner & concrete removal, and more. Standard safety features: protective outer shaft casing, operator presence foot control, electric safety clutch and an E-stop.



Maxi Miller Plus

\$ 11,495.00

3560042012US

1/2" Shaft with Thick Outer Casing.
Separate Control Box with 16ft cord. Requires a 30 Amp Non-GFI Generator/Outlet
 High Speed Cleaning 3-10", Cutting 3-8" & Brush Coating 3-12"
 Range: 100ft. Max Range: 132ft with extension.
 Weight: 205lbs. 500-1475rpm.
 Can be extended 32ft (Extension: 1312020125010 Shaft 1/2" 32ft)

The same great features of the Maxi Miller but with a removable control unit on a 16ft cord. Standard safety features include: protective outer shaft casing, operator presence foot control, electric safety clutch and an E-stop.



Maxi Miller Power+

\$ 17,940.00

3570032018US

3/4" Shaft. **400v, 3-Phase, 30 Amp.**
 High Speed Cleaning 4-12" & Cutting 3-12" (3-4" in straight pipe only).
 Range: 60ft. Max range: 132ft with extension.
 Weight: 284lbs. 500-1500rpm.
 Add 2x36ft extensions. Extension sold separately (1312021180011 Shaft 3/4" 36ft)

For the most challenging jobs the Maxi Power+ is by far the most powerful Picote Miller on the market, taking cleaning, lining removal, and cutting/reinstatements to another level for larger diameter pipes. 400 Volt, 3-phase machine. Safety features include: protective outer shaft casing, shielded operator presence foot control, electric safety clutch and E-stop. Powered by the Picote Generator or comparable unit.



Picote Generator 400v

\$ 14,805.00

1350000022US

Includes a 3.3kVA portable tool transformer with a 110v 15A & 30A socket.
 Weight 794lbs.

Get the most out of your Maxi Power+ with the Picote Generator. Already configured for the Power+ so no need to rewire on site, removing risk of potential damage to the machine and making sure that there is enough power getting to it for those tough jobs. The Picote Generator comes with a 3.3kVA portable tool transformer with a 110v 15A & 30A socket.

Conveniently power all your Millers with the Generator!

Maxi Power+ & Picote Generator

\$ 31,192.20



3570032118US

3/4" Shaft.

High Speed Cleaning 4-12" & Cutting 3-12" (3-4" in straight pipe only).

Range: 60ft. Max range: 132ft with extensions.

Weight: 249lbs. 500-1500rpm.

Add 2x36ft extensions. Extension sold separately (1312021180011 Shaft 3/4" 36ft)
Includes a 3.3kVA portable tool transformer with a 110v 15A & 30A socket.

The Picote Generator comes with a 3.3kVA portable tool transformer with a 110v 15A & 30A socket. Conveniently power all your Millers with the Generator.

A powerful combination at outstanding value!

Mini Cleaner +C

\$6,127.00 (Clean) \$5,962.00 (Cut)



3540001818US (Cleaning Package) 3540001816US (Cutting Package)

1/3" Shaft with Flexible Outer Casing. **Integrated Camera.**

High Speed Cleaning 1/4"-3", Cutting 1/4"-3" & Brush Coating 1/4"-3"

Max Range: 50ft (no extension). Weight: 59lbs. 500-2900rpm.

Camera Specs: Head Diameter 9/16", 98ft cable, 512hz integrated sonde.

7" color monitor. Lighting: 8 LEDs with brightness control

Digital footage counter. Stainless steel camera head (IP68).

Mini Cleaner +C features an integrated 98' color camera that makes viewing of cleaning and cutting jobs easier and helps to make Picote Brush Coating™ setup even simpler. Features a smaller color camera head that allows it to follow the Mini Cleaner through 2" p-traps & bends.

Mini Miller +C

\$ 6,600.00

3540001817US

1/3" Shaft with Thick Outer Casing. **Integrated Camera.**

High Speed Cleaning 2-4" & Cutting 2-3" & Brush Coating 2-6"

Range: 50ft. Max Range: 82ft with extension. Weight: 59lbs. 500-2900rpm.

Camera Specs: Head Diameter 7/8", 98ft cable.

7" cm color monitor. Lighting: 12 LEDs with brightness control

Digital footage counter. Stainless steel camera head (IP68).

Mini Miller +C features an integrated 98' color camera that makes viewing of cleaning and cutting jobs easier and helps to make Picote Brush Coating™ setup even simpler. Self-leveling camera head has a 512hz integrated sonde. Also includes non self-levelling camera head for Picote Brush Coating™.

Battery Powered Mini Cleaner \$ 6,175.00 (Clean) \$ 6,400.00 (Cut)



3540002816US (Cleaning Package) 3540002818US (Cutting Package)

1/3" Shaft with Flexible Outer Casing

High Speed Cleaning 1/4"-3", Cutting 1/4"-3" & Brush Coating 1/4"-3"

Max Range: 50ft (no extension). Weight: 73lbs. Standard Battery Weight: 8lbs

800-2200rpm. Stepless Speed Control (forward & reverse)

The cordless battery powered Mini Cleaner makes quick work of cleaning, descaling, root removal, cutting, reinstatements & brush coating. **Easy to transport and operate regardless of power outlet locations or availability!** Includes Standard Battery for up to 3 hours of continuous work. Can also be used with power cable. High Output Battery (Weight: 9lbs) upgrade for up to 4 hours of continuous work sold separately.



Battery Powered Mini Miller

\$ 6,273.00

3540002817US

1/3" Shaft with Thick Outer Casing
High Speed Cleaning 2-4" & Cutting 2-3" & Brush Coating 2-6"
Range: 50ft. Max Range: 82ft with extension.
Weight: 73lbs. Standard Battery Weight: 8lbs
800-2200rpm Stepless Speed Control (forward & reverse)

The cordless battery powered Mini Miller makes quick work of cleaning, descaling, root removal, cutting, reinstatements & brush coating. **Easy to transport and operate regardless of power outlet locations or availability!** Includes Standard Battery for up to 3 hours of continuous work. Can also be used with power cable. High Output Battery (Weight: 9lbs) upgrade for up to 4 hours of continuous work sold separately.



Battery Powered Mini Cleaner +C \$7,970.00(Clean) \$8,190.00(Cut)

3540003816US (Cleaning Package) 3540003818US (Cutting Package)

1/3" Shaft with Flexible Outer Casing. **Integrated Camera.**
High Speed Cleaning 1/4"-3", Cutting 1/4"-3" & Brush Coating 1/4"-3"
Max Range: 50ft (no extension). Weight: 84lbs. 800-2200rpm Stepless Speed Control
Camera Specs: Head Diameter 9/16", 98ft cable. Stainless steel camera head (IP68).
7" color monitor. Lighting: 8 LEDs with brightness control Digital footage counter.

Designed with plumbers in mind. Same great features as the Battery Powered Mini Cleaner. **Easy to transport and operate regardless of power outlet locations or availability!** Includes Standard Battery (Weight: 8lbs) for up to 3 hours of continuous work. Can also be used with power cable. High Output Battery (Weight: 9lbs) upgrade for up to 4 hours of continuous work sold separately.



Battery Powered Mini Miller +C

\$8,560.00

3540003817US

1/3" Shaft with Thick Outer Casing. **Integrated Camera.**
High Speed Cleaning 2-4" & Cutting 2-3" & Brush Coating 2-6"
Range: 50ft. Max Range: 82ft with extension.
Weight: 84lbs. 800-2200rpm Stepless Speed Control (forward & reverse)
Camera Specs: Head Diameter 7/8", 98ft cable. Stainless steel camera head (IP68).
7" color monitor. Lighting: 12 LEDs with brightness control Digital footage counter.

Same great features as the Battery Powered Mini Miller. **Easy to transport and operate regardless of power outlet locations or availability!** Includes Standard Battery (Weight: 8lbs) for up to 3 hours of continuous work. Can also be used with power cable. High Output Battery (Weight: 9lbs) upgrade for up to 4 hours of continuous work sold separately.



PICOTE KITS

- Picote Starter Kits
- Picote Pro Cleaning Kits
- Picote Pro Cutting Kits

JOIN THE RANKS OF PICOTE PROS WITH KITS THAT COVER ALL THE BASES

There is never a single solution at the worksite, right? With our Picote Kits you can have all of the most commonly used tools to tackle almost any situation. Purchase the kit for the diameter that you mostly work with.

Picote Starter Kit 2" - 1/3" Shaft

\$577.00



1011000050
 Cleaning (1/3" Shaft)
 2" Starter Kit for drain cleaning and descaling, including a Smart Sweeper, Smart Cutter™, Original Premium Chain, Original PVC Chain & Combo Hex Key.

Picote Starter Kit 3" - 1/3" Shaft

\$517.00



1011000075US
 Cleaning (1/3" Shaft)
 3" Starter Kit for drain cleaning and descaling, including new Tiger Drill Chain, Smart Cutter™, Cyclone Premium Chain, Original PVC Chain & Combo Hex Key.

Picote Starter Kit 4" - 1/3" Shaft

\$577.00



1011008100
 Cleaning (1/3" Shaft)
 4" Starter Kit for drain cleaning and descaling, including new Tiger Drill Chain, Smart Cutter™, Cyclone Premium Chain, Original PVC Chain & Combo Hex Key.

Picote Starter Kit 3" - 1/2" Shaft

\$547.00



1011012075US
 Cleaning (1/2" Shaft)
 3" Starter Kit for drain cleaning and descaling, including new Tiger Drill Chain, Smart Cutter™, Cyclone Premium Chain, Original PVC Chain & Combo Hex Key.

Picote Starter Kit 4" - 1/2" Shaft

\$630.00



1011012100
 Cleaning (1/2" Shaft)
 4" Starter Kit for drain cleaning and descaling, including new Tiger Drill Chain, Smart Cutter™, Cyclone Premium Chain, Original PVC Chain & Combo Hex Key.

Picote Starter Kit 6" - 1/2" Shaft

\$697.00



1011012150
 Cleaning (1/2" Shaft)
 6" Starter Kit for drain cleaning and descaling, including new Tiger Drill Chain, Smart Cutter™, Cyclone Premium Chain, Original PVC Chain & Combo Hex Key.

Picote Starter Kit 8" - 1/2" Shaft

\$840.00



1011012200
 Cleaning (1/2" Shaft)
 8" Starter Kit for drain cleaning and descaling, including new Tiger Drill Chain, Smart Cutter™, Cyclone Premium Chain, Original PVC Chain & Combo Hex Key.



Picote Starter Package 4" - 1/2" Shaft

\$1,084.20

1011000100
 Cleaning (1/2" Shaft)
 Smart Cutter™ with 4" Original & Cyclone Premium Chain.



Picote Starter Package 6" - 1/2" Shaft

\$1,240.20

1011000150
 Cleaning (1/2" Shaft)
 Smart Cutter™ with 6" Original & Cyclone Premium Chain.



Picote Pro Cutting Kit 2" - 1/3" Shaft

\$1,834.56

1030008050
 Cutting (1/3" Shaft)
 A customized 2" kit with most commonly used cutting/reinstatement tools, including a Twister Express with a spare Front Drill Head kit, Special Drill Heads and the Smart Cutter™ with spare Side Grinding Panels. Also includes a Sleeve and Leaders.



Picote Pro Cutting Kit 3" - 1/3" Shaft

\$2,385.24

1030008070
 Cutting (1/3" Shaft)
 A customized 3" kit with most commonly used cutting/reinstatement tools, including a Twister Express with a spare Front Drill Head kit, Special Drill Heads and the Smart Cutter™ with spare Side Grinding Panels. Also includes a Sleeve and Leaders.



Picote Pro Cutting Kit 3" - 1/2" Shaft

\$2,385.24

1030012070
 Cutting (1/2" Shaft)
 A customized 3" kit with most commonly used cutting/reinstatement tools, including a Twister Express with a spare Front Drill Head kit, Special Drill Heads and the Smart Cutter™ with spare Side Grinding Panels. Also includes Sleeves, Leaders, Front Metal Panels and a Front Drill Head.



Picote Pro Cutting Kit 4" - 1/2" Shaft

\$2,608.32

1030012100
 Cutting (1/2" Shaft)
 A customized 4" kit with most commonly used cutting/reinstatement tools, including a Twister Express with a spare Front Drill Head kit, Special Drill Heads and the Smart Cutter™ with spare Side Grinding Panels. Also includes Sleeves, Leaders, Front Metal Panels and a Front Drill Head.



Picote Pro Cutting Kit 6" - 1/2" Shaft

\$2,661.36

1030012150
 Cutting (1/2" Shaft)
 A customized 6" kit with most commonly used cutting/reinstatement tools, including a Twister with a spare Front Drill Head kit and the Smart Cutter™ with spare Side Grinding Panels. Also includes Sleeves, Leaders, Front Drill Heads, 2x Front Metal Panel 1mm and 3mm for liner removal.

Picote Pro Cutting Kit 8" - 1/2" Shaft

\$3,007.68

1030012200

Cutting (1/2" Shaft)

A customized 8" kit with most commonly used cutting/reinstatement tools, including a Twister with a spare Front Drill Head kit and the Smart Cutter™ with spare Side Grinding Panels. Also includes a Sleeve, Leaders, Front Drill Heads, 2x Front Metal Panel 1mm and 3mm for liner removal.

Picote Pro Cleaning Kit 2" - 1/3" Shaft

\$1,784.64

1020008050

Cleaning (1/3" Shaft)

A customized 2" kit with most commonly used cleaning/descaling tools, including a Special Drill Head, Leaders, different types of Chains & Brushes, the Smart Cutter™ with spare Side Grinding Panels and the Mini Sweeper with spare Legs.

Picote Pro Cleaning Kit 3" - 1/3" Shaft (US)

\$2,123.16

1020008075US

Cleaning (1/3" Shaft)

A customized 3" kit with most commonly used cleaning/descaling tools, including a Sleeve, a Special Drill Head, Leaders, different types of Chains & Brushes, the Smart Cutter™ with spare Side Grinding Panels and the Mini Sweeper with spare Legs.

Picote Pro Cleaning Kit 4" - 1/3" Shaft

\$2,159.04

1020008100

Cleaning (1/3" Shaft)

A customized 4" kit with most commonly used cleaning/descaling tools, including a Sleeve, a Special Drill Head, Leaders, different types of Chains & Brushes and the Smart Cutter™ with spare Side Grinding Panels.

Picote Pro Cleaning Kit 3" - 1/2" Shaft (US)

\$2,432.04

1020012075US

Cleaning (1/2" Shaft)

A customized 3" kit with most commonly used cleaning/descaling tools, including a Sleeve, a Special Drill Head, Leaders, different types of Chains & Brushes and the Smart Cutter™ with spare Side Grinding Panels.

Picote Pro Cleaning Kit 4" - 1/2" Shaft

\$2,432.04

1020012100

Cleaning (1/2" Shaft)

A customized 4" kit with most commonly used cleaning/descaling tools, including a Sleeve, a Special Drill Head, Leaders, different types of Chains & Brushes, the Smart Cutter™ with spare Side Grinding Panels and the Smart Spider with spare Legs.

Picote Pro Cleaning Kit 6" - 1/2" Shaft

\$2,747.16

1020012150

Cleaning (1/2" Shaft)

A customized 6" kit with most commonly used cleaning/descaling tools, including a Sleeve, a Special Drill Head, Leaders, different types of Chains & Brushes, the Smart Cutter™ with spare Side Grinding Panels and the Smart Spider with spare Legs.

Picote Pro Cleaning Kit 8" - 1/2" Shaft

\$2,917.20

1020012200

Cleaning (1/2" Shaft)

A customized 8" kit with most commonly used cleaning/descaling tools, including a Sleeve, a Special Drill Head, Leaders, different types of Chains & Brushes and the Smart Cutter™ with spare Side Grinding Panels.



Tool Bag Extra Small (11"x5.1"x3.9")

\$89.00

9350000203

Tool Bag

Mix & Match! Build your own custom Picote Tool Kit.



Tool Bag Small (15"x8.3"x5.1")

\$98.00

9350000204

Tool Bag

Mix & Match! Build your own custom Picote Tool Kit.



Tool Bag - Medium (24.8"x7.9"x7.1")

\$133.50

9350000201

Tool Bag

Mix & Match! Build your own custom Picote Tool Kit.



Tool Bag - Large (24.8"x12.6"x11.8")

\$147.00

9350000202

Tool Bag

Mix & Match! Build your own custom Picote Tool Kit.



EXPAND YOUR BUSINESS WITH PICOTE 3D CHAINS

Self-adjusting depending on rpm. Great for diameter transitions or where access is limited, saving you time and money!

Available in both Premium and PVC models:

- 2" to 3" and 3" to 4" for 1/3" Shaft
- 3" to 4" and 4" to 6" for 1/2" Shaft

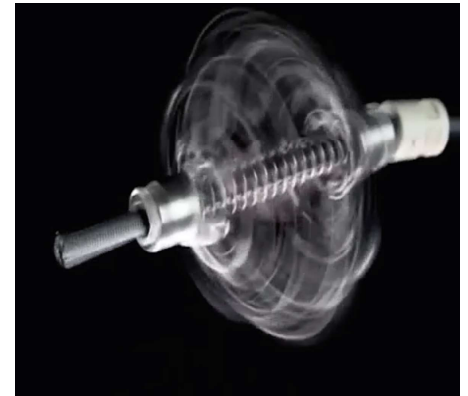
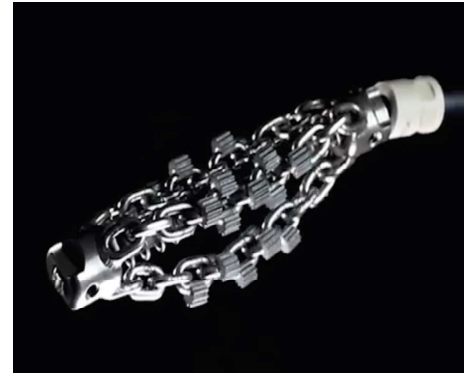

 Check out our video on Cleaning Chains at:
[YouTube.com/PicoteSolutions](https://www.youtube.com/PicoteSolutions)

CLEANING CHAINS

Premium Chains

Larger and heavier U carbide (7-ridge) makes it stronger and faster than any other chain on the market. A versatile tool for cast iron pipes. For tough descaling, hard deposits and removing residual concrete or failed liner, including inconsistencies, wrinkles and remains.

Tiger Chains

Fits in between the Standard & Premium versions. Equipped with extra-hard, very long lasting carbide teeth with a lighter chain material to create a gentle but extremely durable option for cleaning cast iron pipes.

Standard Chains

Star carbide (3-ridge). An efficient general cleaning chain. Suitable for clay, concrete and cast iron pipes.

PVC Chains

No carbides. General cleaning chain to restore flow quickly and safely or to remove light roots in fragile pipes such as plastic, copper & clay.





Original Standard Chain 1 1/4" - 1/4" Shaft

\$42.12

1380065032
Standard (1/4" Shaft)
An efficient cleaning chain without carbides.



Original Standard Chain 2" (2 links) - 1/3" Shaft

\$41.33

1380084050
Standard (1/3" Shaft)
Star carbide (3-ridge). An efficient general cleaning chain. Suitable for clay, concrete and cast iron pipes.



Original Standard Chain 2" (3 links) - 1/3" Shaft

\$45.00

1380184050
Standard (1/3" Shaft)
Star carbide (3-ridge). An efficient general cleaning chain. Suitable for clay, concrete and cast iron pipes.



Original Standard Chain 3" - 1/3" Shaft

\$48.60

1380084070
Standard (1/3" Shaft)
Star carbide (3-ridge). An efficient general cleaning chain. Suitable for clay, concrete and cast iron pipes.



Original Standard Chain 4" - 1/3" Shaft

\$51.66

1380084100
Standard (1/3" Shaft)
Star carbide (3-ridge). An efficient general cleaning chain. Suitable for clay, concrete and cast iron pipes.



Original Standard Chain 5-6" - 1/3" Shaft

\$56.40

1380084150
Standard (1/3" Shaft)
Star carbide (3-ridge). An efficient general cleaning chain. Suitable for clay, concrete and cast iron pipes.



Original Standard Chain 3" - 3/8" Shaft

\$50.10

1380105070
Standard (3/8" Shaft)
Star carbide (3-ridge). An efficient general cleaning chain. Suitable for clay, concrete and cast iron pipes.

Original Standard Chain 4" - 3/8" Shaft

\$51.39



1380105100

Standard (3/8" Shaft)

Star carbide (3-ridge). An efficient general cleaning chain. Suitable for clay, concrete and cast iron pipes.

Original Standard Chain 5-6" - 3/8" Shaft

\$57.30



1380105150

Standard (3/8" Shaft)

Star carbide (3-ridge). An efficient general cleaning chain. Suitable for clay, concrete and cast iron pipes.

Original Standard Chain 3" - 1/2" Shaft

\$51.60



1380125070

Standard (1/2" Shaft)

Star carbide (3-ridge). An efficient general cleaning chain. Suitable for clay, concrete and cast iron pipes.

Original Standard Chain 4" - 1/2" Shaft

\$52.89



1380125100

Standard (1/2" Shaft)

Star carbide (3-ridge). An efficient general cleaning chain. Suitable for clay, concrete and cast iron pipes.

Original Standard Chain 5-6" - 1/2" Shaft

\$58.80



1380125150

Standard (1/2" Shaft)

Star carbide (3-ridge). An efficient general cleaning chain. Suitable for clay, concrete and cast iron pipes.

Original Standard Chain 8" - 1/2" Shaft

\$75.60



1380125200

Standard (1/2" Shaft)

Star carbide (3-ridge). An efficient general cleaning chain. Suitable for clay, concrete and cast iron pipes.

Original Standard Chain 9-10" - 1/2" Shaft

\$94.50



1380125225

Standard (1/2" Shaft)

Star carbide (3-ridge). An efficient general cleaning chain. Suitable for clay, concrete and cast iron pipes.



Original Premium Chain 2'' (2 links) - 1/3'' Shaft

\$124.28

1380084050U

Premium (1/3'' Shaft)

Larger and heavier U carbide (7-ridge) makes it stronger and faster than any other chain on the market. A versatile tool for cast iron pipes. For tough descaling, hard deposits and removing residual concrete or failed liner, including inconsistencies, wrinkles and remains.



Original Premium Chain 2'' (3 links) - 1/3'' Shaft

\$128.78

1380184050U

Premium (1/3'' Shaft)

Larger and heavier U carbide (7-ridge) makes it stronger and faster than any other chain on the market. A versatile tool for cast iron pipes. For tough descaling, hard deposits and removing residual concrete or failed liner, including inconsistencies, wrinkles and remains.



Original Premium Chain 3'' - 1/3'' Shaft

\$148.30

1380084070U

Premium (1/3'' Shaft)

Larger and heavier U carbide (7-ridge) makes it stronger and faster than any other chain on the market. A versatile tool for cast iron pipes. For tough descaling, hard deposits and removing residual concrete or failed liner, including inconsistencies, wrinkles and remains.



Original Premium Chain 4'' - 1/3'' Shaft

\$172.10

1380084100U

Premium (1/3'' Shaft)

Larger and heavier U carbide (7-ridge) makes it stronger and faster than any other chain on the market. A versatile tool for cast iron pipes. For tough descaling, hard deposits and removing residual concrete or failed liner, including inconsistencies, wrinkles and remains.



Original Premium Chain 5-6'' - 1/3'' Shaft

\$214.50

1380084150U

Premium (1/3'' Shaft)

Larger and heavier U carbide (7-ridge) makes it stronger and faster than any other chain on the market. A versatile tool for cast iron pipes. For tough descaling, hard deposits and removing residual concrete or failed liner, including inconsistencies, wrinkles and remains.



Original Premium Chain 3'' - 1/2'' Shaft

\$150.60

1380125070U

Premium (1/2'' Shaft)

Larger and heavier U carbide (7-ridge) makes it stronger and faster than any other chain on the market. A versatile tool for cast iron pipes. For tough descaling, hard deposits and removing residual concrete or failed liner, including inconsistencies, wrinkles and remains.



Original Premium Chain 4'' - 1/2'' Shaft

\$171.80

1380125100U

Premium (1/2'' Shaft)

Larger and heavier U carbide (7-ridge) makes it stronger and faster than any other chain on the market. A versatile tool for cast iron pipes. For tough descaling, hard deposits and removing residual concrete or failed liner, including inconsistencies, wrinkles and remains.



Original Premium Chain 5-6" - 1/2" Shaft

\$187.90

1380125150U

Premium (1/2" Shaft)

Larger and heavier U carbide (7-ridge) makes it stronger and faster than any other chain on the market. A versatile tool for cast iron pipes. For tough descaling, hard deposits and removing residual concrete or failed liner, including inconsistencies, wrinkles and remains.



Original Premium Chain 8" - 1/2" Shaft

\$263.60

1380125200U

Premium (1/2" Shaft)

Larger and heavier U carbide (7-ridge) makes it stronger and faster than any other chain on the market. A versatile tool for cast iron pipes. For tough descaling, hard deposits and removing residual concrete or failed liner, including inconsistencies, wrinkles and remains.



Original Premium Chain 9-10" - 1/2" Shaft

\$326.85

1380125225U

Premium (1/2" Shaft)

Larger and heavier U carbide (7-ridge) makes it stronger and faster than any other chain on the market. A versatile tool for cast iron pipes. For tough descaling, hard deposits and removing residual concrete or failed liner, including inconsistencies, wrinkles and remains.



Original Premium Chain 4" - 3/4" Shaft

\$191.45

1380185100U

Premium (3/4" Shaft)

Larger and heavier U carbide (7-ridge) makes it stronger and faster than any other chain on the market. A versatile tool for cast iron pipes. For tough descaling, hard deposits and removing residual concrete or failed liner, including inconsistencies, wrinkles and remains.



Original Premium Chain 5-6" - 3/4" Shaft

\$234.40

1380185150U

Premium (3/4" Shaft)

Larger and heavier U carbide (7-ridge) makes it stronger and faster than any other chain on the market. A versatile tool for cast iron pipes. For tough descaling, hard deposits and removing residual concrete or failed liner, including inconsistencies, wrinkles and remains.



Original Premium Chain 8" - 3/4" Shaft

\$277.90

1380185200U

Premium (3/4" Shaft)

Larger and heavier U carbide (7-ridge) makes it stronger and faster than any other chain on the market. A versatile tool for cast iron pipes. For tough descaling, hard deposits and removing residual concrete or failed liner, including inconsistencies, wrinkles and remains.



Original Premium Chain 9-10" - 3/4" Shaft

\$369.15

1380185250U

Premium (3/4" Shaft)

Larger and heavier U carbide (7-ridge) makes it stronger and faster than any other chain on the market. A versatile tool for cast iron pipes. For tough descaling, hard deposits and removing residual concrete or failed liner, including inconsistencies, wrinkles and remains.



Original Premium Chain 12'' - 3/4'' Shaft

\$428.60

1380185300U

Premium (3/4'' Shaft)

Larger and heavier U carbide (7-ridge) makes it stronger and faster than any other chain on the market. A versatile tool for cast iron pipes. For tough descaling, hard deposits and removing residual concrete or failed liner, including inconsistencies, wrinkles and remains.



Cleaning Chain 1 1/4'' - 1/3'' Shaft

\$14.70

1381084032

PVC (1/3'' Shaft)

Cleaning Chain without Carbides. For the Mini Cleaner.



Cleaning Chain 1.57'' - 1/3'' Shaft

\$14.85

1381084040

PVC (1/3'' Shaft)

Cleaning Chain without Carbides. For the Mini Cleaner.



Original PVC Chain 2'' - 1/3'' Shaft

\$37.44

1380084050P

PVC (1/3'' Shaft)

No carbides. General cleaning chain to restore flow quickly and safely or to remove light roots in fragile pipes such as plastic, copper and clay.



Original PVC Chain 3'' - 1/3'' Shaft

\$42.12

1380084070P

PVC (1/3'' Shaft)

No carbides. General cleaning chain to restore flow quickly and safely or to remove light roots in fragile pipes such as plastic, copper and clay.



Original PVC Chain 4'' - 1/3'' Shaft

\$45.24

1380084100P

PVC (1/3'' Shaft)

No carbides. General cleaning chain to restore flow quickly and safely or to remove light roots in fragile pipes such as plastic, copper and clay.



Original PVC Chain 5-6'' - 1/3'' Shaft

\$49.92

1380084150P

PVC (1/3'' Shaft)

No carbides. General cleaning chain to restore flow quickly and safely or to remove light roots in fragile pipes such as plastic, copper and clay.



Original PVC Chain 3' - 3/8' Shaft

\$46.50

1380105070P

PVC (3/8" Shaft)

No carbides. General cleaning chain to restore flow quickly and safely or to remove light roots in fragile pipes such as plastic, copper and clay.



Original PVC Chain 4' - 3/8' Shaft

\$49.89

1380105100P

PVC (3/8" Shaft)

No carbides. General cleaning chain to restore flow quickly and safely or to remove light roots in fragile pipes such as plastic, copper and clay.



Original PVC Chain 5-6' - 3/8' Shaft

\$55.80

1380105150P

PVC (3/8" Shaft)

No carbides. General cleaning chain to restore flow quickly and safely or to remove light roots in fragile pipes such as plastic, copper and clay.



Original PVC Chain 3' - 1/2' Shaft

\$49.88

1380125070P

PVC (1/2" Shaft)

No carbides. General cleaning chain to restore flow quickly and safely or to remove light roots in fragile pipes such as plastic, copper and clay.



Original PVC Chain 4' - 1/2' Shaft

\$51.39

1380125100P

PVC (1/2" Shaft)

No carbides. General cleaning chain to restore flow quickly and safely or to remove light roots in fragile pipes such as plastic, copper and clay.



Original PVC Chain 6' - 1/2' Shaft

\$57.30

1380125150P

PVC (1/2" Shaft)

No carbides. General cleaning chain to restore flow quickly and safely or to remove light roots in fragile pipes such as plastic, copper and clay.



Original PVC Chain 8' - 1/2' Shaft

\$74.10

1380125200P

PVC (1/2" Shaft)

No carbides. General cleaning chain to restore flow quickly and safely or to remove light roots in fragile pipes such as plastic, copper and clay.



Cyclone Standard Chain 3" - 1/3" Shaft (US)

\$62.70

1381084075

Standard (1/3" Shaft)

Star carbide (3-ridge). No need to adjust, the centrifugal force centers the tool inside the pipe, providing greater protection for damaged or fragile pipes. Suitable for clay, concrete and cast iron pipes.



Cyclone Standard Chain 4" - 1/3" Shaft

\$75.53

1381084100

Standard (1/3" Shaft)

Star carbide (3-ridge). No need to adjust, the centrifugal force centers the tool inside the pipe, providing greater protection for damaged or fragile pipes. Suitable for clay, concrete and cast iron pipes.



Cyclone Standard Chain 5" - 1/3" Shaft

\$89.78

1381084125

Standard (1/3" Shaft)

Star carbide (3-ridge). No need to adjust, the centrifugal force centers the tool inside the pipe, providing greater protection for damaged or fragile pipes. Suitable for clay, concrete and cast iron pipes.



Cyclone Standard Chain 6" - 1/3" Shaft

\$92.63

1381084150

Standard (1/3" Shaft)

Star carbide (3-ridge). No need to adjust, the centrifugal force centers the tool inside the pipe, providing greater protection for damaged or fragile pipes. Suitable for clay, concrete and cast iron pipes.



Cyclone Standard Chain 3" - 3/8" Shaft

\$67.50

1381105070

Standard (3/8" Shaft)

Star carbide (3-ridge). No need to adjust, the centrifugal force centers the tool inside the pipe, providing greater protection for damaged or fragile pipes. Suitable for clay, concrete and cast iron pipes.



Cyclone Standard Chain 4" - 3/8" Shaft

\$76.50

1381105100

Standard (3/8" Shaft)

Star carbide (3-ridge). No need to adjust, the centrifugal force centers the tool inside the pipe, providing greater protection for damaged or fragile pipes. Suitable for clay, concrete and cast iron pipes.



Cyclone Standard Chain 5" - 3/8" Shaft

\$96.00

1381105125

Standard (3/8" Shaft)

Star carbide (3-ridge). No need to adjust, the centrifugal force centers the tool inside the pipe, providing greater protection for damaged or fragile pipes. Suitable for clay, concrete and cast iron pipes.



Cyclone Standard Chain 6" - 3/8" Shaft

\$97.50

1381105150

Standard (3/8" Shaft)

Star carbide (3-ridge). No need to adjust, the centrifugal force centers the tool inside the pipe, providing greater protection for damaged or fragile pipes. Suitable for clay, concrete and cast iron pipes.



Cyclone Standard Chain 3" - 1/2" Shaft (US)

\$64.13

1381125075

Standard (1/2" Shaft)

Star carbide (3-ridge). No need to adjust, the centrifugal force centers the tool inside the pipe, providing greater protection for damaged or fragile pipes. Suitable for clay, concrete and cast iron pipes.



Cyclone Standard Chain 4" - 1/2" Shaft

\$74.10

1381125100

Standard (1/2" Shaft)

Star carbide (3-ridge). No need to adjust, the centrifugal force centers the tool inside the pipe, providing greater protection for damaged or fragile pipes. Suitable for clay, concrete and cast iron pipes.



Cyclone Standard Chain 5" - 1/2" Shaft

\$92.63

1381125125

Standard (1/2" Shaft)

Star carbide (3-ridge). No need to adjust, the centrifugal force centers the tool inside the pipe, providing greater protection for damaged or fragile pipes. Suitable for clay, concrete and cast iron pipes.



Cyclone Standard Chain 6" - 1/2" Shaft

\$94.05

1381125150

Standard (1/2" Shaft)

Star carbide (3-ridge). No need to adjust, the centrifugal force centers the tool inside the pipe, providing greater protection for damaged or fragile pipes. Suitable for clay, concrete and cast iron pipes.



Cyclone Standard Chain 8" - 1/2" Shaft

\$112.58

1381125200

Standard (1/2" Shaft)

Star carbide (3-ridge). No need to adjust, the centrifugal force centers the tool inside the pipe, providing greater protection for damaged or fragile pipes. Suitable for clay, concrete and cast iron pipes.



Cyclone Standard Chain 9" - 1/2" Shaft

\$132.53

1381125225

Standard (1/2" Shaft)

Star carbide (3-ridge). No need to adjust, the centrifugal force centers the tool inside the pipe, providing greater protection for damaged or fragile pipes. Suitable for clay, concrete and cast iron pipes.

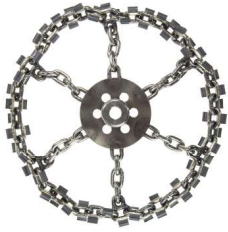

Cyclone Standard Chain 10" - 1/2" Shaft

\$139.65

1381125250

Standard (1/2" Shaft)

Star carbide (3-ridge). No need to adjust, the centrifugal force centers the tool inside the pipe, providing greater protection for damaged or fragile pipes. Suitable for clay, concrete and cast iron pipes.



Cyclone Premium Chain 3" - 1/3" Shaft (US)

\$210.50

1381084075U

Premium (1/3" Shaft)

Larger and heavier U carbide (7-ridge) makes it stronger and faster than any other chain in the market. No need to adjust, the centrifugal force centers the tool inside the pipe. For tough descaling, hard deposits and removing residual concrete or failed liner.



Cyclone Premium Chain 4" - 1/3" Shaft

\$234.30

1381084100U

Premium (1/3" Shaft)

Larger and heavier U carbide (7-ridge) makes it stronger and faster than any other chain in the market. No need to adjust, the centrifugal force centers the tool inside the pipe. For tough descaling, hard deposits and removing residual concrete or failed liner.



Cyclone Premium Chain 5" - 1/3" Shaft

\$255.45

1381084125U

Premium (1/3" Shaft)

Larger and heavier U carbide (7-ridge) makes it stronger and faster than any other chain in the market. No need to adjust, the centrifugal force centers the tool inside the pipe. For tough descaling, hard deposits and removing residual concrete or failed liner.



Cyclone Premium Chain 3" - 1/2" Shaft (US)

\$211.50

1381125075U

Premium (1/2" Shaft)

Larger and heavier U carbide (7-ridge) makes it stronger and faster than any other chain in the market. No need to adjust, the centrifugal force centers the tool inside the pipe. For tough descaling, hard deposits and removing residual concrete or failed liner.



Cyclone Premium Chain 4" Chain - 1/2" Shaft

\$236.90

1381125100U

Premium (1/2" Shaft)

Larger and heavier U carbide (7-ridge) makes it stronger and faster than any other chain in the market. No need to adjust, the centrifugal force centers the tool inside the pipe. For tough descaling, hard deposits and removing residual concrete or failed liner.



Cyclone Premium Chain 5" - 1/2" Shaft

\$257.01

1381125125U

Premium (1/2" Shaft)

Larger and heavier U carbide (7-ridge) makes it stronger and faster than any other chain in the market. No need to adjust, the centrifugal force centers the tool inside the pipe. For tough descaling, hard deposits and removing residual concrete or failed liner.



Cyclone Premium Chain 6" - 1/2" Shaft

\$271.20

1381125150U

Premium (1/2" Shaft)

Larger and heavier U carbide (7-ridge) makes it stronger and faster than any other chain in the market. No need to adjust, the centrifugal force centers the tool inside the pipe. For tough descaling, hard deposits and removing residual concrete or failed liner.



Cyclone Premium Chain 8" - 1/2" Shaft

\$323.00

1381125200U

Premium (1/2" Shaft)

Larger and heavier U carbide (7-ridge) makes it stronger and faster than any other chain in the market. No need to adjust, the centrifugal force centers the tool inside the pipe. For tough descaling, hard deposits and removing residual concrete or failed liner.



Cyclone Premium Chain 10" - 1/2" Shaft

\$325.09

1381125225U

Premium (1/2" Shaft)

Larger and heavier U carbide (7-ridge) makes it stronger and faster than any other chain in the market. No need to adjust, the centrifugal force centers the tool inside the pipe. For tough descaling, hard deposits and removing residual concrete or failed liner.



Cyclone Premium Chain 12" - 1/2" Shaft

\$413.25

1381125250U

Premium (1/2" Shaft)

Larger and heavier U carbide (7-ridge) makes it stronger and faster than any other chain in the market. No need to adjust, the centrifugal force centers the tool inside the pipe. For tough descaling, hard deposits and removing residual concrete or failed liner.



Cyclone PVC Chain 3" - 1/3" Shaft (US)

\$138.00

1381084075P

PVC (1/3" Shaft)

No carbides. Self-centering, general cleaning chain for descaling and removing light roots in fragile pipes such as plastic, copper and clay.



Cyclone PVC Chain 4" - 1/3" Shaft

\$62.40

1381084100P

PVC (1/3" Shaft)

No carbides. Self-centering, general cleaning chain for descaling and removing light roots in fragile pipes such as plastic, copper and clay.



Cyclone PVC Chain 5" - 1/3" Shaft

\$67.08

1381084125P

PVC (1/3" Shaft)

No carbides. Self-centering, general cleaning chain for descaling and removing light roots in fragile pipes such as plastic, copper and clay.



Cyclone PVC Chain 3" - 3/8" Shaft

\$54.00

1381105070P

PVC (3/8" Shaft)

No carbides. Self-centering, general cleaning chain for descaling and removing light roots in fragile pipes such as plastic, copper and clay.



Cyclone PVC Chain 4" - 3/8" Shaft

\$58.50

1381105100P

PVC (3/8" Shaft)

No carbides. Self-centering, general cleaning chain for descaling and removing light roots in fragile pipes such as plastic, copper and clay.



Cyclone PVC Chain 5" - 3/8" Shaft

\$64.50

1381105125P

PVC (3/8" Shaft)

No carbides. Self-centering, general cleaning chain for descaling and removing light roots in fragile pipes such as plastic, copper and clay.



Cyclone PVC Chain 6" - 3/8" Shaft

\$67.50

1381105150P

PVC (3/8" Shaft)

No carbides. Self-centering, general cleaning chain for descaling and removing light roots in fragile pipes such as plastic, copper and clay.



Cyclone PVC Chain 3" - 1/2" Shaft (US)

\$57.72

1381125075P

PVC (1/2" Shaft)

No carbides. Self-centering, general cleaning chain for descaling and removing light roots in fragile pipes such as plastic, copper and clay.



Cyclone PVC Chain 4" - 1/2" Shaft

\$62.40

1381125100P

PVC (1/2" Shaft)

No carbides. Self-centering, general cleaning chain for descaling and removing light roots in fragile pipes such as plastic, copper and clay.



Cyclone PVC Chain 5" - 1/2" Shaft

\$68.64

1381125125P

PVC (1/2" Shaft)

No carbides. Self-centering, general cleaning chain for descaling and removing light roots in fragile pipes such as plastic, copper and clay.



Cyclone PVC Chain 6" - 1/2" Shaft

\$71.76

1381125150P

PVC (1/2" Shaft)

No carbides. Self-centering, general cleaning chain for descaling and removing light roots in fragile pipes such as plastic, copper and clay.



Cyclone PVC Chain 8" - 1/2" Shaft

\$81.12

1381125200P

PVC (1/2" Shaft)

No carbides. Self-centering, general cleaning chain for descaling and removing light roots in fragile pipes such as plastic, copper and clay.



3D Premium Chain 2-3" w/Leader - 1/3" Shaft

\$208.00

1382005070

Premium (1/3" Shaft)

Save time and money at the worksite. By controlling the speed, the 3D Chain continues to expand as it removes material until it reaches its maximum size. Also for navigating diameter transitions. Unique 'U carbide' (7-ridge). Includes Leader.



3D Premium Chain 3-4" w/Leader - 1/3" Shaft

\$231.00

1382070100

Premium (1/3" Shaft)

Save time and money at the worksite. By controlling the speed, the 3D Chain continues to expand as it removes material until it reaches its maximum size. Also for navigating diameter transitions. Unique 'U carbide' (7-ridge). Includes Leader.



3D Premium Chain 3-4" w/Leader - 1/2" Shaft

\$244.00

1383070100

Premium (1/2" Shaft)

Save time and money at the worksite. By controlling the speed, the 3D Chain continues to expand as it removes material until it reaches its maximum size. Also for navigating diameter transitions. Unique 'U carbide' (7-ridge). Includes Leader.



3D Premium Chain 4-6" w/Leader - 1/2" Shaft

\$277.00

1383100150

Premium (1/2" Shaft)

Save time and money at the worksite. By controlling the speed, the 3D Chain continues to expand as it removes material until it reaches its maximum size. Also for navigating diameter transitions. Unique 'U carbide' (7-ridge). Includes Leader.



Spare Chain - 3D Premium 2-3" - 1/3" Shaft

\$170.04

1380084050D

Spare Part 3D Chain

Replacement 3D Premium Chain - U carbide (7-ridge). Chain only.

	<p>Spare Chain - 3D Premium 3-4" - 1/3" Shaft</p> <p>1380084070D Spare Part 3D Chain Replacement 3D Premium Chain - U carbide (7-ridge). Chain only.</p>	<p>\$188.76</p>
	<p>Spare Chain - 3D Premium 3-4" - 1/2" Shaft</p> <p>1380125070D Spare Part 3D Chain Replacement 3D Premium Chain - U carbide (7-ridge). Chain only.</p>	<p>\$209.04</p>
	<p>Spare Chain - 3D Premium 4-6" - 1/2" Shaft</p> <p>1380125100D Spare Part 3D Chain Replacement 3D Premium Chain - U carbide (7-ridge). Chain only.</p>	<p>\$238.68</p>
	<p>Spare Spring - 3D Premium 2-3" - 1/3" Shaft</p> <p>9380000054 Spare Part 3D Chain Spare Spring for 3D Chain.</p>	<p>\$30.26</p>
	<p>Spare Spring - 3D Premium 3-4" - 1/3" Shaft</p> <p>9380000055 Spare Part 3D Chain Spare Spring for 3D Chain.</p>	<p>\$31.66</p>
	<p>Spare Spring - 3D Premium 3-4" - 1/2" Shaft</p> <p>9380000056 Spare Part 3D Chain Spare Spring for 3D Chain.</p>	<p>\$31.66</p>
	<p>Spare Spring - 3D Premium 4-6" - 1/2" Shaft</p> <p>9380000057 Spare Part 3D Chain Spare Spring for 3D Chain.</p>	<p>\$33.21</p>

Spare Leader- 3D Premium 2-3" - 1/3" Shaft

\$55.50



1382005071

Spare Part 3D Chain

Spare Leader (includes the shaft, casing and sleeve bearings).

Spare Leader - 3D Premium 3-4" - 1/3" Shaft

\$60.00



1382070101

Spare Part 3D Chain

Spare Leader (includes the shaft, casing and sleeve bearings).

Spare Leader - 3D Premium 3-4" - 1/2" Shaft

\$61.50



1383070101

Spare Part 3D Chain

Spare Leader (includes the shaft, casing and sleeve bearings).

Spare Leader - 3D Premium 4-6" - 1/2" Shaft

\$67.50



1383100151

Spare Part 3D Chain

Spare Leader (includes the shaft, casing and sleeve bearings).

3D PVC Chain 2-3" w/Leader - 1/3" Shaft

\$142.50



1382005070P

PVC (1/3" Shaft)

Save time and money at the worksite. By controlling the speed, the 3D Chain continues to expand as it removes material until it reaches its maximum size. Also for navigating diameter transitions. No carbides. For plastic or fragile pipes. Includes Leader.

3D PVC Chain 3-4" w/Leader - 1/3" Shaft

\$147.00



1382070100P

PVC (1/3" Shaft)

Save time and money at the worksite. By controlling the speed, the 3D Chain continues to expand as it removes material until it reaches its maximum size. Also for navigating diameter transitions. No carbides. For plastic or fragile pipes. Includes Leader.

3D PVC Chain 3-4" w/Leader - 1/2" Shaft

\$195.00



1383070100P

PVC (1/2" Shaft)

Save time and money at the worksite. By controlling the speed, the 3D Chain continues to expand as it removes material until it reaches its maximum size. Also for navigating diameter transitions. No carbides. For plastic or fragile pipes. Includes Leader.



Spare Chain - 3D PVC Chain 2-3" - 1/3" Shaft

\$97.50

1380084050DP

Spare Part 3D Chain
Replacement 3D PVC Chain for 1/3" Shaft. Chain only.



Spare Chain - 3D PVC Chain 3-4" - 1/3" Shaft

\$102.00

1380084070DP

Spare Part 3D Chain
Replacement 3D PVC Chain for 1/3" Shaft. Chain only.



Spare Chain - 3D PVC Chain 3-4" - 1/2" Shaft

\$133.50

1380125070DP

Spare Part 3D Chain
Replacement 3D PVC Chain for 1/2" Shaft. Chain only.

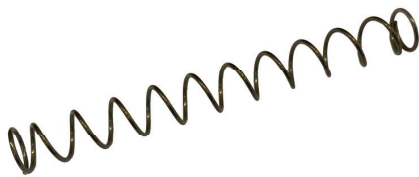

Spare Spring - 3D PVC Chain 2-3" - 1/3" Shaft

\$30.26

9380000058

Spare Part 3D Chain
Spare Spring for 3D Chain for 1/3" Shaft.

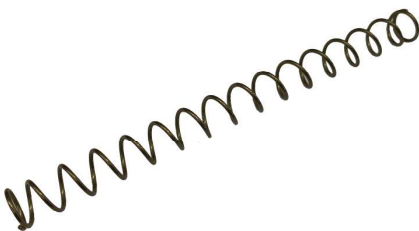

Spare Spring - 3D PVC Chain 3-4" - 1/3" Shaft

\$31.66

9380000059

Spare Part 3D Chain
Spare Spring for 3D Chain for 1/3" Shaft.

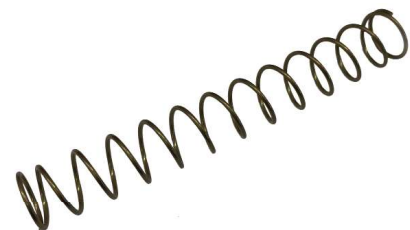

Spare Spring - 3D PVC Chain 3-4" - 1/2" Shaft

\$31.66

9380000070

Spare Part 3D Chain
Spare Spring for 3D Chain for 1/2" Shaft.



Spare Leader - 3D PVC Chain 2-3" - 1/3" Shaft

\$55.50

1382005071P

Spare Part 3D Chain
Includes the shaft, casing and sleeve bearings.

Spare Leader - 3D PVC Chain 3-4" - 1/3" Shaft

\$60.00



1382070101P

Spare Part 3D Chain

Includes the shaft, casing and sleeve bearings.

Spare Leader - 3D PVC Chain 3-4" - 1/2" Shaft

\$61.50



1383070101P

Spare Part 3D Chain

Includes the shaft, casing and sleeve bearings.

Tiger Original Chain 2" - 1/3" Shaft

\$100.50



1380084050V

Tiger (1/3" Shaft)

Equipped with extra-hard, very long lasting carbide teeth with a lighter chain material to create a gentle but extremely durable option for cleaning cast iron pipes.

Tiger Original Chain 3" - 1/3" Shaft

\$108.00



1380084070V

Tiger (1/3" Shaft)

Equipped with extra-hard, very long lasting carbide teeth with a lighter chain material to create a gentle but extremely durable option for cleaning cast iron pipes.

Tiger Original Chain 4" - 1/3" Shaft

\$112.50



1380084100V

Tiger (1/3" Shaft)

Equipped with extra-hard, very long lasting carbide teeth with a lighter chain material to create a gentle but extremely durable option for cleaning cast iron pipes.

Tiger Original Chain 6" - 1/3" Shaft

\$120.00



1380084150V

Tiger (1/3" Shaft)

Equipped with extra-hard, very long lasting carbide teeth with a lighter chain material to create a gentle but extremely durable option for cleaning cast iron pipes.

Tiger Original Chain 3" - 3/8" Shaft

\$111.00



1380105070V

Tiger (3/8" Shaft)

Equipped with extra-hard, very long lasting carbide teeth with a lighter chain material to create a gentle but extremely durable option for cleaning cast iron pipes.



Tiger Original Chain 4' - 3/8' Shaft

\$115.50

1380105100V

Tiger (3/8" Shaft)

Equipped with extra-hard, very long lasting carbide teeth with a lighter chain material to create a gentle but extremely durable option for cleaning cast iron pipes.



Tiger Original Chain 6' - 3/8' Shaft

\$129.00

1380105150V

Tiger (3/8" Shaft)

Equipped with extra-hard, very long lasting carbide teeth with a lighter chain material to create a gentle but extremely durable option for cleaning cast iron pipes.



Tiger Original Chain 8' - 3/8' Shaft

\$129.00

1380105200V

Tiger (3/8" Shaft)

Equipped with extra-hard, very long lasting carbide teeth with a lighter chain material to create a gentle but extremely durable option for cleaning cast iron pipes.



Tiger Original Chain 3' - 1/2' Shaft

\$114.00

1380125070V

Tiger (1/2" Shaft)

Equipped with extra-hard, very long lasting carbide teeth with a lighter chain material to create a gentle but extremely durable option for cleaning cast iron pipes.



Tiger Original Chain 4' - 1/2' Shaft

\$118.50

1380125100V

Tiger (1/2" Shaft)

Equipped with extra-hard, very long lasting carbide teeth with a lighter chain material to create a gentle but extremely durable option for cleaning cast iron pipes.



Tiger Original Chain 6' - 1/2' Shaft

\$123.00

1380125150V

Tiger (1/2" Shaft)

Equipped with extra-hard, very long lasting carbide teeth with a lighter chain material to create a gentle but extremely durable option for cleaning cast iron pipes.



Tiger Original Chain 8' - 1/2' Shaft

\$132.00

1380125200V

Tiger (1/2" Shaft)

Equipped with extra-hard, very long lasting carbide teeth with a lighter chain material to create a gentle but extremely durable option for cleaning cast iron pipes.

Tiger Original Chain 9-10" - 1/2" Shaft

\$147.00



1380125250V

Tiger (1/2" Shaft)

Equipped with extra-hard, very long lasting carbide teeth with a lighter chain material to create a gentle but extremely durable option for cleaning cast iron pipes.

Tiger Drill Chain 3" - 1/3" Shaft

\$142.50



1380084070VP

Tiger (1/3" Shaft)

Original Tiger Chain with an integrated front drill head featuring the long lasting carbides to help cut through roots and lightly collapsed liners.

Tiger Drill Chain 4" - 1/3" Shaft

\$157.50



1380084100VP

Tiger (1/3" Shaft)

Original Tiger Chain with an integrated front drill head featuring the long lasting carbides to help cut through roots and lightly collapsed liners.

Tiger Drill Chain 3" - 3/8" Shaft

\$145.50



1380105070VP

Tiger (3/8" Shaft)

Original Tiger Chain with an integrated front drill head featuring the long lasting carbides to help cut through roots and lightly collapsed liners.

Tiger Drill Chain 4" - 3/8" Shaft

\$160.50



1380105100VP

Tiger (3/8" Shaft)

Original Tiger Chain with an integrated front drill head featuring the long lasting carbides to help cut through roots and lightly collapsed liners.

Tiger Drill Chain 6" - 3/8" Shaft

\$169.50



1380105150VP

Tiger (3/8" Shaft)

Original Tiger Chain with an integrated front drill head featuring the long lasting carbides to help cut through roots and lightly collapsed liners.

Tiger Drill Chain 8" - 3/8" Shaft

\$187.50



1380105200VP

Tiger (3/8" Shaft)

Original Tiger Chain with an integrated front drill head featuring the long lasting carbides to help cut through roots and lightly collapsed liners.



Tiger Drill Chain 3' - 1/2' Shaft

\$148.50

1380125070VP

Tiger (1/2" Shaft)

Original Tiger Chain with an integrated front drill head featuring the long lasting carbides to help cut through roots and lightly collapsed liners.



Tiger Drill Chain 4' - 1/2' Shaft

\$165.00

1380125100VP

Tiger (1/2" Shaft)

Original Tiger Chain with an integrated front drill head featuring the long lasting carbides to help cut through roots and lightly collapsed liners.



Tiger Drill Chain 6' - 1/2' Shaft

\$172.50

1380125150VP

Tiger (1/2" Shaft)

Original Tiger Chain with an integrated front drill head featuring the long lasting carbides to help cut through roots and lightly collapsed liners.



Tiger Drill Chain 8' - 1/2' Shaft

\$195.00

1380125200VP

Tiger (1/2" Shaft)

Original Tiger Chain with an integrated front drill head featuring the long lasting carbides to help cut through roots and lightly collapsed liners.



Tiger Drill Chain 9-10' - 1/2' Shaft

\$214.50

1380125250VP

Tiger (1/2" Shaft)

Original Tiger Chain with an integrated front drill head featuring the long lasting carbides to help cut through roots and lightly collapsed liners.



Tiger Cyclone Chain 3' - 1/3' Shaft

\$139.50

1381084075V

Tiger (1/3" Shaft)

A gentle, lightweight option for cleaning cast iron pipes, with extra-hard, long lasting carbide teeth. Centrifugal force centers the tool inside the pipe, providing greater protection for damaged or fragile pipes.



Tiger Cyclone Chain 4' - 1/3' Shaft

\$148.50

1381084100V

Tiger (1/3" Shaft)

A gentle, lightweight option for cleaning cast iron pipes, with extra-hard, long lasting carbide teeth. Centrifugal force centers the tool inside the pipe, providing greater protection for damaged or fragile pipes.



Tiger Cyclone Chain 6" - 1/3" Shaft

\$195.00

1381084150V

Tiger (1/3" Shaft)

A gentle, lightweight option for cleaning cast iron pipes, with extra-hard, long lasting carbide teeth. Centrifugal force centers the tool inside the pipe, providing greater protection for damaged or fragile pipes.



Tiger Cyclone Chain 3" - 3/8" Shaft

\$142.50

1381105075V

Tiger (3/8" Shaft)

A gentle, lightweight option for cleaning cast iron pipes, with extra-hard, long lasting carbide teeth. Centrifugal force centers the tool inside the pipe, providing greater protection for damaged or fragile pipes.



Tiger Cyclone Chain 4" 3/8" Shaft

\$153.50

1381105100V

Tiger (3/8" Shaft)

A gentle, lightweight option for cleaning cast iron pipes, with extra-hard, long lasting carbide teeth. Centrifugal force centers the tool inside the pipe, providing greater protection for damaged or fragile pipes.

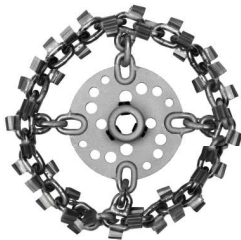

Tiger Cyclone Chain 6" - 3/8" Shaft

\$202.50

1381105150V

Tiger (3/8" Shaft)

A gentle, lightweight option for cleaning cast iron pipes, with extra-hard, long lasting carbide teeth. Centrifugal force centers the tool inside the pipe, providing greater protection for damaged or fragile pipes.



Tiger Cyclone Chain 8" - 3/8" Shaft

\$234.00

1381105200V

Tiger (3/8" Shaft)

A gentle, lightweight option for cleaning cast iron pipes, with extra-hard, long lasting carbide teeth. Centrifugal force centers the tool inside the pipe, providing greater protection for damaged or fragile pipes.



Tiger Cyclone Chain 3" - 1/2" Shaft

\$144.00

1381125075V

Tiger (1/2" Shaft)

A gentle, lightweight option for cleaning cast iron pipes, with extra-hard, long lasting carbide teeth. Centrifugal force centers the tool inside the pipe, providing greater protection for damaged or fragile pipes.



Tiger Cyclone Chain 4" - 1/2" Shaft

\$154.51

1381125100V

Tiger (1/2" Shaft)

A gentle, lightweight option for cleaning cast iron pipes, with extra-hard, long lasting carbide teeth. Centrifugal force centers the tool inside the pipe, providing greater protection for damaged or fragile pipes.



Tiger Cyclone Chain 6" - 1/2" Shaft

\$205.50

1381125150V

Tiger (1/2" Shaft)

A gentle, lightweight option for cleaning cast iron pipes, with extra-hard, long lasting carbide teeth. Centrifugal force centers the tool inside the pipe, providing greater protection for damaged or fragile pipes.

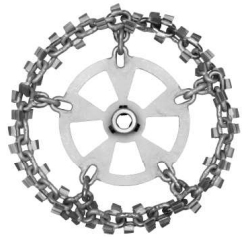

Tiger Cyclone Chain 8" - 1/2" Shaft

\$237.00

1381125200V

Tiger (1/2" Shaft)

A gentle, lightweight option for cleaning cast iron pipes, with extra-hard, long lasting carbide teeth. Centrifugal force centers the tool inside the pipe, providing greater protection for damaged or fragile pipes.

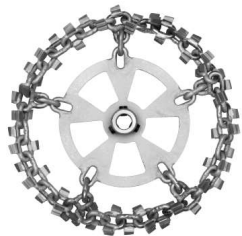

Tiger Cyclone Chain 10" - 1/2" Shaft

\$262.50

1381125250V

Tiger (1/2" Shaft)

A gentle, lightweight option for cleaning cast iron pipes, with extra-hard, long lasting carbide teeth. Centrifugal force centers the tool inside the pipe, providing greater protection for damaged or fragile pipes.



Tiger Drill Chain PVC 3" - 1/3" Shaft

\$112.50

1382084070P

Tiger PVC (1/3" Shaft)

Tiger Original PVC Chain with an integrated front drill head featuring the long lasting carbides to efficiently and safely cut through roots, scale and blockages in PVC and fragile pipes. An essential "first fix" tool!



Tiger Drill Chain PVC 4" - 1/3" Shaft

\$120.00

1382084100P

Tiger PVC (1/3" Shaft)

Tiger Original PVC Chain with an integrated front drill head featuring the long lasting carbides to efficiently and safely cut through roots, scale and blockages in PVC and fragile pipes. An essential "first fix" tool!



Tiger Drill Chain PVC 3" - 3/8" Shaft

\$115.50

1382105070P

Tiger PVC (3/8" Shaft)

Tiger Original PVC Chain with an integrated front drill head featuring the long lasting carbides to efficiently and safely cut through roots, scale and blockages in PVC and fragile pipes. An essential "first fix" tool!



Tiger Drill Chain PVC 4" - 3/8" Shaft

\$123.00

1382105100P

Tiger PVC (3/8" Shaft)

Tiger Original PVC Chain with an integrated front drill head featuring the long lasting carbides to efficiently and safely cut through roots, scale and blockages in PVC and fragile pipes. An essential "first fix" tool!



Tiger Drill Chain PVC 6" - 3/8" Shaft

\$130.50

1382105150P

Tiger PVC (3/8" Shaft)

Tiger Original PVC Chain with an integrated front drill head featuring the long lasting carbides to efficiently and safely cut through roots, scale and blockages in PVC and fragile pipes. An essential "first fix" tool!



Tiger Drill Chain PVC 3" - 1/2" Shaft

\$118.50

1382125070P

Tiger PVC (1/2" Shaft)

Tiger Original PVC Chain with an integrated front drill head featuring the long lasting carbides to efficiently and safely cut through roots, scale and blockages in PVC and fragile pipes. An essential "first fix" tool!



Tiger Drill Chain PVC 4" - 1/2" Shaft

\$126.00

1382125100P

Tiger PVC (1/2" Shaft)

Tiger Original PVC Chain with an integrated front drill head featuring the long lasting carbides to efficiently and safely cut through roots, scale and blockages in PVC and fragile pipes. An essential "first fix" tool!



Tiger Drill Chain PVC 6" - 1/2" Shaft

\$133.50

1382125150P

Tiger PVC (1/2" Shaft)

Tiger Original PVC Chain with an integrated front drill head featuring the long lasting carbides to efficiently and safely cut through roots, scale and blockages in PVC and fragile pipes. An essential "first fix" tool!



SMART SPIDER

Efficient tool for removing fats, oil & grease. Also the best option for damaged or fragile pipes where there are holes or the pipe has rotted away at the base, allowing you to pass through to descale and prep for lining.

Designed for 4" and 6" pipes for the Super Midi Miller and Maxi Miller and 6", 8" & 9" pipes for the Maxi Power+.



 Check out our video on Spiders at:
[YouTube.com/PicoteSolutions](https://www.youtube.com/PicoteSolutions)

SPECIAL CLEANING TOOLS

Mini Smart Sweeper

Compact, flexible and self-adjusting for tackling hard scale even through 2" p-traps. Versatile tool for tough cleaning scenarios including tuberculation, roots, calcite, & mineral/uranic scale in cast iron, concrete, clay & PVC pipes. There are 2" & 3" models for the Mini Cleaner & Mini Miller and a 4" version for the Super Midi & Maxi Millers.

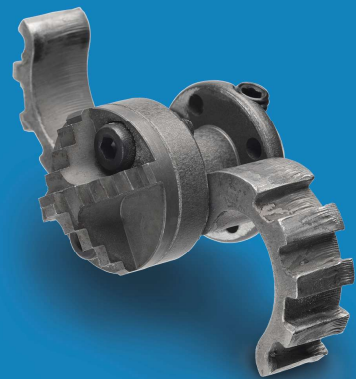



Smart Spider 4" - 1/2" Shaft

\$725.00

1390125102

Cleaning (1/2" Shaft)

Efficient tool for removing fats, oil & grease. Also our best option for damaged or fragile pipes where there are holes or the pipe has rotted away at the base, allowing you to pass through to descale and prep for lining.



Smart Spider 6" - 1/2" Shaft

\$755.00

1390125152

Cleaning (1/2" Shaft)

Efficient tool for removing fats, oil & grease. Also our best option for damaged or fragile pipes where there are holes or the pipe has rotted away at the base, allowing you to pass through to descale and prep for lining.



Smart Spider 4" Legs

\$40.25

1390100001

Spider Spare Part

Spare legs (12pcs) for 4" Smart Spider (can be used with 6" Spider to change to 4" size).



Smart Spider 6" Legs

\$45.86

1390100002

Spider Spare Part

Spare legs (12pcs) for 6" Smart Spider (can be used with 4" Spider to change to 6" size).



Smart Spider Rubber Flex

\$89.30

1390100005

Spider Spare Part

Spare Rubber for 4" and 6" Smart Spider. Includes 10pcs.



Smart Spider Axle

\$73.48

1390100004

Spider Spare Part

Spare Axle for 4" and 6" Smart Spider. Includes 6pcs.



Mini Smart Sweeper 1.5"-2" - 1/3" Shaft

\$307.00

1360080050

Cleaning (1/3" Shaft)

Game changer for 1 1/2-2" pipes. Versatile tool for tough cleaning scenarios including tuberculation, roots, calcite, & mineral/uranic scale in cast iron, concrete, clay, & PVC pipes. Includes 1x Front Drill Head 1" & Hub Disc 2".



Mini Smart Sweeper 3" - 1/3" Shaft

\$397.00

1360080075

Cleaning (1/3" Shaft)

Versatile tool for tough cleaning scenarios including tuberculation, roots, calcite, & mineral/uranic scale in cast iron, concrete, clay, & PVC pipes. Includes 1x Front Drill Head 1.57" & Hub Disc 3".



Mini Smart Sweeper 4" - 1/2" Shaft

\$569.00

1360120100

Cleaning (1/2" Shaft)

Versatile tool for tough cleaning scenarios including tuberculation, roots, calcite, & mineral/uranic scale in cast iron, concrete, clay, & PVC pipes. Comes with Spring Leader.



Smart Sweeper Head 4" - 1/2" Shaft

\$322.50

1360120101

Sweeper Spare Part

Spare Head for 4" Sweeper.

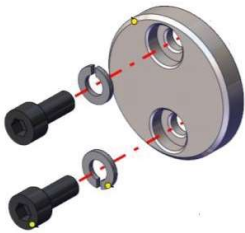

Hub Disc for Smart Sweeper 2"

\$19.11

1000200025

Sweeper Spare Part

Hub Disc for 2" Smart Sweeper with Screws.

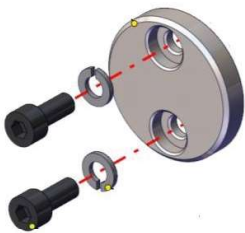

Hub Disc for Smart Sweeper 3"

\$22.23

1360080002

Sweeper Spare Part

Hub Disc for 3" Smart Sweeper with Screws.



Hub Disc for Smart Sweeper 4" & Smart Spider 4" & 6"

\$22.23

1390125001

Sweeper Spare Part

Hub Disc for Smart Sweeper 4" & Smart Spider 4" & 6" with Screws.



Mini Sweeper Leg 2"

\$48.35

900000935

Sweeper Spare Part

Price per leg (2 needed).



Mini Sweeper Leg 3"

\$67.88

900000942
Sweeper Spare Part
Price per leg (2 needed).



Mini Sweeper Leg 4"

\$74.62

900000938
Sweeper Spare Part
Price per Leg (6 needed).



Front Drill Head 1" for Smart Sweeper 2"

\$99.84

1300212025
Sweeper Spare Part
For 2" Smart Sweeper.



Front Drill Head 4 Flat 1.57"-2" for Smart Sweeper 3"

\$148.60

1300214042
Sweeper & Spider Spare Part
Flat 1.6" No Thread. Can also be used with a Mini Smart Sweeper 4" and Smart Spider 4" and 6".



Twister Metal Grinder 4" - 1/2" Shaft

\$756.00

1233075101N
Metal Grinder (1/2" Shaft)
Quickly and efficiently grinds away most metal including rebar, steel rods, nails, screws, and lead joints in 4" pipes. Safe option even inside PVC and clay pipe.



Stone Replacement Head 4"

\$118.40

900000776
Metal Grinder Spare Part
Replacement Carborundum stone cutting head.

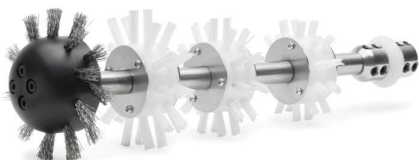

Twister Cleaner 4" - 1/2" Shaft

\$742.00

1230085100CL
Cleaning (1/2" Shaft)
Designed for light cleaning and working in plastic & fragile pitch fiber & Orangeburg pipe.



Wire Cleaning Brush 2" - 1/3" Shaft

\$31.40

2125000050CL

Cleaning (1/3" Shaft)

Metal cleaning brush for removing fine dust or light mineral deposits in PVC and fragile pipes. Also used for brush coating pipe preparation.

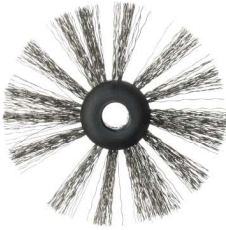

Wire Cleaning Brush 3" - 1/3" Shaft

\$32.60

2125000075CL

Cleaning (1/3" Shaft)

Metal cleaning brush for removing fine dust or light mineral deposits in PVC and fragile pipes. Also used for brush coating pipe preparation.



Wire Cleaning Brush 4" - 1/3" Shaft

\$35.90

2125000100CL

Cleaning (1/3" Shaft)

Metal cleaning brush for removing fine dust or light mineral deposits in PVC and fragile pipes. Also used for brush coating pipe preparation.

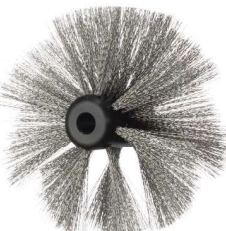

Wire Cleaning Brush 6" - 1/3" Shaft

\$44.70

2125000150CL

Cleaning (1/3" Shaft)

Metal cleaning brush for removing fine dust or light mineral deposits in PVC and fragile pipes. Also used for brush coating pipe preparation.



Wire Cleaning Brush 4" - 1/2" Shaft

\$78.22

2125012100CL

Cleaning (1/2" Shaft)

Metal cleaning brush for removing fine dust or light mineral deposits in PVC and fragile pipes. Also used for brush coating pipe preparation.



Wire Cleaning Brush 5" - 1/2" Shaft

\$81.12

2125012125CL

Cleaning (1/2" Shaft)

Metal cleaning brush for removing fine dust or light mineral deposits in PVC and fragile pipes. Also used for brush coating pipe preparation.



Wire Cleaning Brush 6" - 1/2" Shaft

\$90.48

2125012150CL

Cleaning (1/2" Shaft)

Metal cleaning brush for removing fine dust or light mineral deposits in PVC and fragile pipes. Also used for brush coating pipe preparation.

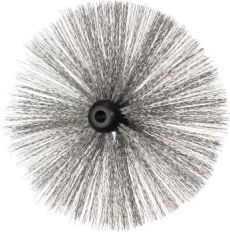

Wire Cleaning Brush 8" - 1/2" Shaft

\$137.28

2125012200CL

Cleaning (1/2" Shaft)

Metal cleaning brush for removing fine dust or light mineral deposits in PVC and fragile pipes. Also used for brush coating pipe preparation.



Wire Cleaning Brush 9" - 1/2" Shaft

\$140.40

2125012225CL

Cleaning (1/2" Shaft)

Metal cleaning brush for removing fine dust or light mineral deposits in PVC and fragile pipes. Also used for brush coating pipe preparation.



Wire Cleaning Brush 10" - 1/2" Shaft

\$149.76

2125012250CL

Cleaning (1/2" Shaft)

Metal cleaning brush for removing fine dust or light mineral deposits in PVC and fragile pipes. Also used for brush coating pipe preparation.



Wire Cleaning Brush 12" - 1/2" Shaft

\$152.88

2125012300CL

Cleaning (1/2" Shaft)

Metal cleaning brush for removing fine dust or light mineral deposits in PVC and fragile pipes. Also used for brush coating pipe preparation.

NEW TIGER TWISTER LINER & CONCRETE REMOVER

Two tough jobs, one tougher tool. Remove failed CIPP lining twice as fast as with a regular Twister Liner Remover or remove concrete from the pipe. A must-have for every tool box.

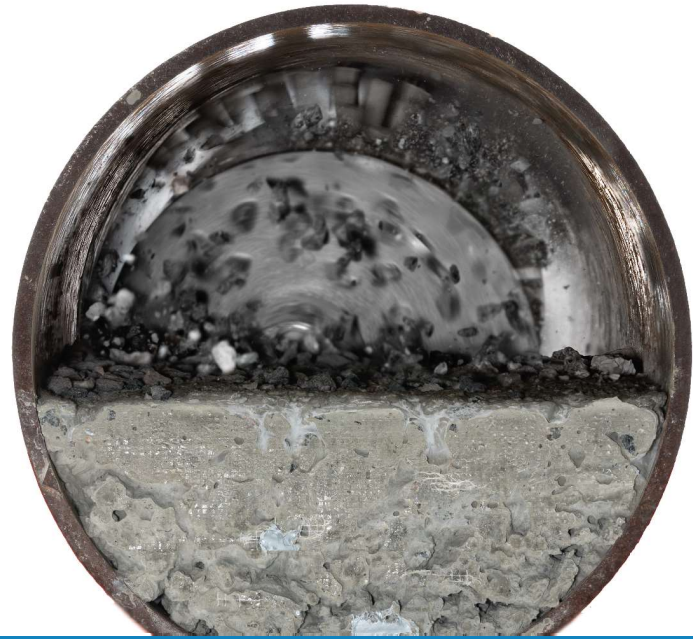
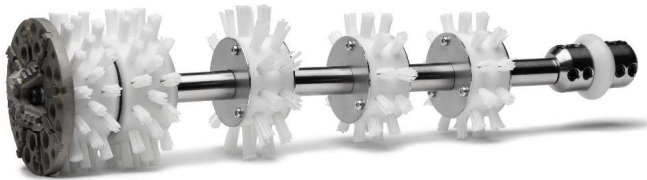

TWISTER CONCRETE & LINER REMOVERS

Twister Concrete Remover

The Twister Concrete Remover has dual front brushes for added stability, a heavy duty front panel with large carbides, and a specialised front drill head with star carbides, all of which combine for efficient concrete, grout, slurry, & rock removal.

Twister Liner Remover

The Twister Liner Remover's dual front brushes provide added stability. The heavy duty front panel with large carbides and drill head are excellent for removing failed liners.





Twister Concrete Remover 4" - 1/2" Shaft

\$1,209.00

1234085100

Concrete Remover (1/2" Shaft)

3mm Front Metal Panel: 3.3" (1210510085). For efficient concrete, grout, slurry, & rock removal. Dual front brushes provide added stability while the heavy duty Front Metal Panel with large carbides and specialized Front Drill Head deliver great results.



Twister Concrete Remover 6" - 1/2" Shaft

\$1,263.60

1234125150

Concrete Remover (1/2" Shaft)

3mm Front Metal Panel: 5" (1210510125). For efficient concrete, grout, slurry, & rock removal. Dual front brushes provide added stability while the heavy duty Front Metal Panel with large carbides and specialized Front Drill Head deliver great results.



Twister Concrete Remover 4" + Steering Axle - 1/2" Shaft **\$1,302.60**

1234085100SA

Concrete Remover (1/2" Shaft)

3mm Front Metal Panel: 3.3" (1210510085). For efficient concrete, grout, slurry, & rock removal where pipe is less than 50% full of material and you have access points at both ends. Feed a Steering Wire through the pipe and attach it to Steering Axle (1100100055) on the Twister.



Twister Concrete Remover 6" + Steering Axle - 1/2" Shaft **\$1,365.00**

1234125150SA

Concrete Remover (1/2" Shaft)

3mm Front Metal Panel: 5" (1210510125). For efficient concrete, grout, slurry, & rock removal where pipe is less than 50% full of material and you have access points at both ends. Feed a Steering Wire through the pipe and attach it to Steering Axle (1100100055) on the Twister.



Twister Liner Remover 4" Lined Pipe

\$1,146.60

1233075100

Liner Remover (1/2" Shaft)

Features two front brushes for stability with a custom built Flat Drill Head. The 3mm Front Metal Panel 3"(1210410075) has aggressive carbides resulting in efficient liner removal in cast iron and concrete pipes.



Twister Liner Remover 4" for Unlined Pipe

\$1,146.60

1233085100

Liner Remover (1/2" Shaft)

Features two front brushes for stability with a custom built flat Drill Head. The 3mm Front Metal Panel 3.3" (1210410085) has aggressive carbides resulting in efficient liner removal in cast iron and concrete pipes.



Twister Liner Remover 6" for Lined Pipe

\$1,240.20

1231115150Y

Liner Remover (1/2" Shaft)

Features two front brushes for stability with a custom built flat Drill Head. The 3mm Front Metal Panel 4.5" (1210410115) has aggressive carbides resulting in efficient liner removal in cast iron and concrete pipes.

Twister Liner Remover 6" for Unlined Pipe

\$1,240.20



1230125150Y

Liner Remover (1/2" Shaft)

Features two front brushes for stability with a custom built flat Drill Head. The 3mm Front Metal Panel 5" (1210410125) has aggressive carbides resulting in efficient liner removal in cast iron and concrete pipes.

Tiger Twister Liner & Concrete Remover 4" Lined

\$1,252.50



1263075100

Liner & Concrete Remover (1/2" Shaft)

Two tough jobs, one tougher tool. Remove failed CIPP lining twice as fast as with a regular Twister Liner Remover or remove concrete from the pipe. A must-have for every tool box. Front Metal Panel: 3", thickness 6mm.

Tiger Twister Liner & Concrete Remover 4" Unlined

\$1,267.50

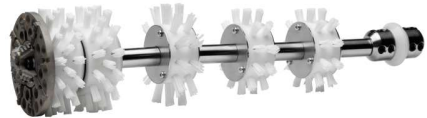

1263085100

Liner & Concrete Remover (1/2" Shaft)

Two tough jobs, one tougher tool. Remove failed CIPP lining twice as fast as with a regular Twister Liner Remover or remove concrete from the pipe. A must-have for every tool box. Front Metal Panel: 3.3", thickness 6mm.

Tiger Twister Liner & Concrete Remover 6" Lined

\$1,342.50



1263115150

Liner & Concrete Remover (1/2" Shaft)

Two tough jobs, one tougher tool. Remove failed CIPP lining twice as fast as with a regular Twister Liner Remover or remove concrete from the pipe. A must-have for every tool box. Front Metal Panel: 4.5", thickness 6mm.

Tiger Twister Liner & Concrete Remover 6" Unlined

\$1,357.50

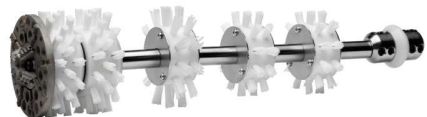

1263125150

Liner & Concrete Remover (1/2" Shaft)

Two tough jobs, one tougher tool. Remove failed CIPP lining twice as fast as with a regular Twister Liner Remover or remove concrete from the pipe. A must-have for every tool box. Front Metal Panel: 5", thickness 6mm.

HAVE IT YOUR WAY

Picote Brush Coating™ gives you options when rehabilitating pipes from 1 1/4" - 12". Prolong the lifespan of an existing pipe. Clean the pipe well and apply single or dual coats of Picote epoxy resin. The new slick inner surface increases flow inside the pipe, minimising the risk of blockages. Alternatively, apply several coats of the resin forming a seamless new semi-structural pipe, providing a solution that should last 30-50 years.

Benefits: Extend the service life of a pipe, stop corrosion, create a new pipe, "patch" on top of a compatible CIPP lining and fortify connections. Improve quality control with the dual color cartridge system. Apply with the Smart Mixer 2.0 for a simple and mess-free solution.

Apartments & High-Rises
Nuclear & Industrial
Hydro-Electric
Residential & Municipal
Pools, Fountains & Tanks

 Check out our video on Brush Coating at: [YouTube.com/PicoteSolutions](https://www.youtube.com/PicoteSolutions)

PICOTE BRUSH COATING™



DUAL COLOR EPOXY

Alternate between the gray and white resins so that you can easily visually verify each layer. Apply to small areas or all drains in multi-story buildings.





Mini Coating Pump US

\$7,128.00

2220100002

Mini Pump

Pipe Diameter: 1.25-6". Max Range: 75ft. Weight: 35.5lbs

Safely secures to Miller frame. Combine with the Mini Miller or the Mini Cleaner for a portable compact system. Clean and coat with one simple system. Includes Resin Cup Package, 3x Hose Connectors, Hose Clamps and 2x Brush Stoppers.



Resin Supply Hose 82ft

\$189.64

2220100004

Mini Pump

82ft. per package

For inside pump housing. Precise measurements required. Consult the operating manual.



Resin Supply Hose Package

\$108.00

2220100011

Mini Pump

Pre-cut to 9.4", 50 pieces per package.

For inside pump housing.



Delivery Hose 82ft

\$79.25

2220100003

Mini Pump

82ft./package.

For delivering Picote Dual Color Epoxy from Resin Cup to the Mini Pump and from the pump to the pipe.



Delivery Hose 656ft

\$210.00

2220100009

Mini Pump

656ft./package.

For delivering Picote Dual Color Epoxy from Resin Cup to the Mini Pump and from the pump to the pipe.



Hose Connector with Hose Clamps

\$112.19

2220100007

Mini Pump

Includes Hose Connector & Hose Clamps (10mm & 13mm).



Hose Clamp 10mm

\$2.73

9500000382

Mini Pump

For Mini Coating Pump Delivery Hose.

Includes one Hose Clamp.



Hose Clamp 13mm

\$2.99

950000381

Mini Pump
For Mini Coating Pump Delivery Hose.
Includes one Hose Clamp.



Brush Stopper 1/3"

\$15.96

900000338

Mini Pump
Provides extra security to keep the Coating Brush on the shaft.
Includes one Brush Stopper.



Maxi Coating Pump US

\$10,374.00

222020001

Maxi Pump
Pipe Diameter: 3-12". Max Range: 128ft. Weight: 51lbs.
Safely secures to Miller frame. Combine with the Super Midi or the Maxi Miller.
Clean and coat with one simple system. When used with Super Midi, add the Maxi Pump Bracket (9550004000).
Includes: Maxi Pumping Hose Package, 10x Resin Cups and 2 Hose Clamps.



Maxi Coating Pump Delivery Hose

\$273.00

222020005

Maxi Pump
656ft./package.



Maxi Pumping Hose Package

\$94.00

222020003

Maxi Pump
Includes 10pcs in a package with 2x Hose Connector per piece.
For inside pump housing.



Coating Resin Cup Package

\$27.30

222020004

Maxi Pump & Mini Pump
10pcs in a package.
Same resin cup size for Mini & Maxi Pumps.



Hose Clamp 16mm

\$4.45

900000902

Maxi Pump
For Maxi Coating Pump Delivery Hose.
Includes one Hose Clamp.



Brush Stopper 1/2"

\$30.40

900000756

Maxi Pump

Provides extra security to keep the Coating Brush on the shaft.
Includes one Brush Stopper.



Maxi Pump Bracket for Super Midi

\$262.50

9550004000

Maxi Pump

Attaches Maxi Coating Pump to a Super Midi Miller frame.



Picote Heater US

\$2,250.00

1350000024US

Maxi Pump & Mini Pump

Decrease time between coats for Picote Brush Coating™ system.

Includes 16ft Heater Hose. Air outlet temperature is limited to 131F.

Automatic thermal cut-out in both motor and heating element.

Max. air velocity up to 100m/s and max. air volume 2.20m³/min. Minimal noise: 78dBA.



Heater Hose 16.4ft

\$172.00

9990001099

Picote Heater Spare Part

Includes 4x Heater Hose Clamps.



Coating/Cleaning Brush 1.5" for 1.25" Pipe

\$29.25

2120000037

Mini Pump (1/4" Shaft)

Custom designed, high-quality and long lasting brush with nylon bristles for brush coating and cleaning PVC pipes.

Clean with acetone and reuse.



Coating/Cleaning Brush 2" for 1.25" Pipe

\$31.15

2120000050

Mini Pump (1/3" Shaft)

Custom designed, high-quality and long lasting brush with nylon bristles for brush coating and cleaning PVC pipes.

Clean with acetone and reuse.

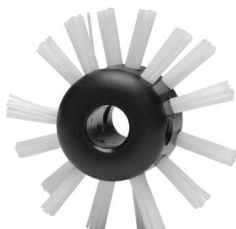

Coating/Cleaning Brush 3" for 2" Pipe

\$23.93

2120000075

Mini Pump (1/3" Shaft)

Custom designed, high-quality and long lasting brush with nylon bristles for brush coating and cleaning PVC pipes.

Clean with acetone and reuse.

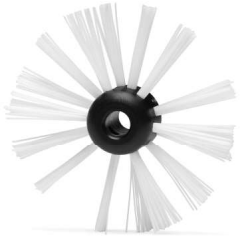

Coating/Cleaning Brush 4'' for 3'' Pipe

\$24.68

2120000100

Mini Pump (1/3" Shaft)

Custom designed, high-quality and long lasting brush with nylon bristles for brush coating and cleaning PVC pipes.

Clean with acetone and reuse.



Coating/Cleaning Brush 5'' for 4'' Pipe

\$26.63

2120000125

Mini Pump (1/3" Shaft)

Custom designed, high-quality and long lasting brush with nylon bristles for brush coating and cleaning PVC pipes.

Clean with acetone and reuse.



Coating/Cleaning Brush 6.9'' for 6'' Pipe

\$45.79

2120000175

Mini Pump (1/3" Shaft)

Custom designed, high-quality and long lasting brush with nylon bristles for brush coating and cleaning PVC pipes.

Clean with acetone and reuse.



Coating/Cleaning Brush 8.7'' for 8'' Pipe

\$47.92

2120000220

Mini Pump (1/3" Shaft)

Custom designed, high-quality and long lasting brush with nylon bristles for brush coating and cleaning PVC pipes.

Clean with acetone and reuse.

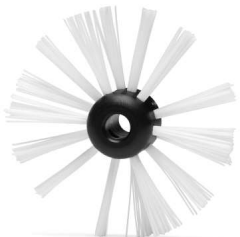

Coating/Cleaning Brush 4'' for 3'' Pipe

\$54.00

2120012100

Maxi Pump (1/2" Shaft)

Custom designed, high-quality and long lasting brush with nylon bristles for brush coating and cleaning PVC pipes.

Clean with acetone and reuse.

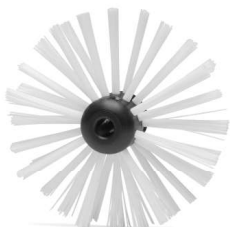

Coating/Cleaning Brush 5'' for 4'' Pipe

\$54.00

2120012125

Maxi Pump (1/2" Shaft)

Custom designed, high-quality and long lasting brush with nylon bristles for brush coating and cleaning PVC pipes.

Clean with acetone and reuse.



Coating/Cleaning Brush 6'' for 4'' Pipe

\$59.00

2120012150

Maxi Pump (1/2" Shaft)

Custom designed, high-quality and long lasting brush with nylon bristles for brush coating and cleaning PVC pipes.

Clean with acetone and reuse.

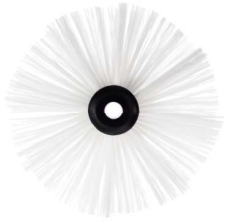

Coating/Cleaning Brush 7" for 5" Pipe

\$62.00

2120012175

Maxi Pump (1/2" Shaft)

Custom designed, high-quality and long lasting brush with nylon bristles for brush coating and cleaning PVC pipes.

Clean with acetone and reuse.

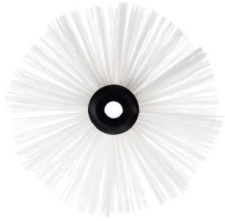

Coating/Cleaning Brush 8" for 6" Pipe

\$76.00

2120012200

Maxi Pump (1/2" Shaft)

Custom designed, high-quality and long lasting brush with nylon bristles for brush coating and cleaning PVC pipes.

Clean with acetone and reuse.



Coating/Cleaning Brush 9" for 7" Pipe

\$82.00

2120012225

Maxi Pump (1/2" Shaft)

Custom designed, high-quality and long lasting brush with nylon bristles for brush coating and cleaning PVC pipes.

Clean with acetone and reuse.

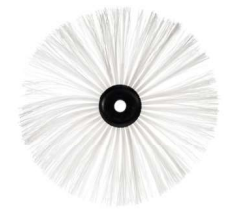

Coating/Cleaning Brush 10" for 8" Pipe

\$87.00

2120012250

Maxi Pump (1/2" Shaft)

Custom designed, high-quality and long lasting brush with nylon bristles for brush coating and cleaning PVC pipes.

Clean with acetone and reuse.

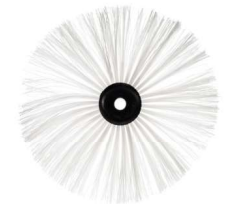

Coating/Cleaning Brush 11" for 9" Pipe

\$93.00

2120012275

Maxi Pump (1/2" Shaft)

Custom designed, high-quality and long lasting brush with nylon bristles for brush coating and cleaning PVC pipes.

Clean with acetone and reuse.



Coating/Cleaning Brush 12" for 10" Pipe

\$99.00

2120012300

Maxi Pump (1/2" Shaft)

Custom designed, high-quality and long lasting brush with nylon bristles for brush coating and cleaning PVC pipes.

Clean with acetone and reuse.



Coating/Cleaning Brush 14" for 12" Pipe

\$105.00

2120012350

Maxi Pump (1/2" Shaft)

Custom designed, high-quality and long lasting brush with nylon bristles for brush coating and cleaning PVC pipes.

Clean with acetone and reuse.

Picote Dual Color Epoxy Kit, 12lbs 5oz

\$369.00



2110001001

6 Cartridge Kit (3x white & 3x gray) with 8 Tips & 3 Nuts.

100% Solids Epoxy designed exclusively for the Picote Brush Coating™ System. Rehabilitate decayed and damaged concrete, PVC, fiberglass, clay, cast iron and ductile pipes. Extend the service life of a pipe, stop corrosion, create a new semi structural pipe, "patch" on top of CIPP liner or fortify connections. Apply to small areas or all pipes in multi-story buildings.

The simple Dual Color method allows for clear visual verification during application. With multiple coats, the resin forms a semi-structural pipe inside the original pipe that is safe, tested and environmentally friendly. The new pipe is wear-resistant with a corrosion resistant barrier. Due to high breaking stretch, the new pipe withstands shocks and bending. It is also elastic and antistatic.

Picote White Epoxy Kit, 12lbs 5oz

\$369.00



2110001001W

6 Cartridge Kit (6x white) with 8 Tips & 3 Nuts.

ASTM and NSF Certified (meets the requirements of NSF/ANSI 61-5). WRC approved with Picote Brush Coating™ System.

Picote Gray Epoxy Kit, 12lbs 5oz

\$369.00



2110001001G

6 Cartridge Kit (6x gray) with 8 Tips & 3 Nuts.

ASTM Certified. WRC approved with Picote Brush Coating™ System. Finish with Picote White Epoxy to be NSF Certified.

Fast Cure Dual Epoxy Kit, 12lbs 5oz

\$472.00



2110001010

6 Cartridge Kit (3x white & 3x gray) with 8 Tips & 3 Nuts.

A faster curing version of Picote Dual Color 100% Solids Epoxy resin. Ideal for efficient, experienced Picote Brush coating installers. Same high-quality epoxy as our standard epoxy, but with a FASTER curing time. A must-have for shorter runs. Used to rehabilitate decayed and damaged concrete, PVC, fiberglass, clay, cast iron and ductile pipelines.

The Dual Color method allows for clear visual verification during application. Designed exclusively for the Picote Brush Coating™ System. ASTM Certified.

Fast Cure White Epoxy Kit, 12lbs 5oz

\$472.00



2110001011

6 Cartridge Kit (6x white) with 8 Tips & 3 Nuts.

Fast Cure Gray Epoxy Kit, 12lbs 5oz

\$472.00



2110001012

6 Cartridge Kit (6x gray) with 8 Tips & 3 Nuts.



Picote Fiber Bonded Mastic, 14lbs 10oz, White

\$365.00

2110002001

6 Cartridge Kit with 8 Tips & 3 Nuts.

Used to protect new infrastructure and to rehabilitate existing damaged infrastructure, including manholes, steel substrates, floor and wall penetrations/cracks, wet wells, vaults & septic tanks. Extreme bonding to nearly all substrates. Fast curing & easy workability. ¼" build capability with no sag. Use with the Smart Mixer—no mixing means faster application.

Picote Smart Fill

\$720.00

2110002004

6 cartridges per case

Specially designed flowable fill product that can be used to fill in the bottom of fully deteriorated piping or areas where holes and voids exist. Remove excess foam in pipe with the Picote Premium Cyclone Chain (3" or bigger pipe) or Picote Smart Cutter™ (2" or smaller pipe). Then you are ready to line or coat the pipe. Use with the Smart Mixer 2.0, cartridge tip, and resin supply hose to apply directly to the pipe.



Delivery Hose Lube, 1 Quart

\$115.25

2110000003

Maxi Pump & Mini Pump

Used to lubricate the inner surface of the Coating Pump Delivery Hose in order to increase resin pumping speed. If you find it difficult to push the brush/hose assembly through pipes with bends you can also apply a small amount to reduce pipe friction.



Cartridge Tip

\$39.75

2110000001

Includes 10 Static Mixing Tips.



Cartridge Nut

\$8.20

2110000002

Includes 10 Cartridge Nuts.



Picote Smart Mixer 2.0

\$750.00

2130001001

Weight: 9.3 lbs. Speed: Variable up to 6"/min (2.5mm/sec).

Battery: 20V Li-Ion. Charger: One hour quick charge 110V. Top load cartridge holder.

Battery powered variable speed cartridge mixer in carrying case with spare battery, charger & additional large piston. A highly useful tool for accurate and proven mixing results when pumping the 2 part epoxies for coating, Smart Fill, and trowelable mastic used for repairing various structures.

Spare parts:

Piston/Plunger 300ml (2110000004)

\$23.30

Piston/Plunger 600ml (2110000005)

\$23.30





Smart Mixer 2.0 Battery Charger

\$119.00

2130001007US

Smart Mixer Spare Part
Charger, 20V Li-Ion fast charger with US cordset to be used with Picote Smart Mixer 2.0.



Smart Mixer 2.0 Original Battery

\$149.00

2130001008

Smart Mixer Spare Part
Battery, 20V Lithium Ion to be used with Picote Smart Mixer 2.0. Lighter and slimmer design (mixer is nearly 1lb lighter with new battery). More efficient Lithium Ion design. Power capacity indicator lights. Faster charging with longer life.



Smart Mixer Original Battery Charger

\$99.99

2130001005US

Smart Mixer Spare Part
Battery charger for US cordset to be used with Smart Mixer Original.



Smart Mixer Original Battery

\$99.99

2130001006

Smart Mixer Spare Part
Battery for US to be used with Smart Mixer Original.
Smart Mixer 2.0 is equipped with a Li-Ion battery.

WE KNOW CIPP LINING! WE HAVE THE TOOLS YOU NEED FOR A SUCCESSFUL PROJECT

Our Picote CIPP Services Team work tirelessly with our R&D Team to ensure that we have the best tools for CIPP lining. Tried and tested at our own worksites across Finland.

Want to learn more about our range of lining equipment and tools? Check out our FREE 101 CIPP Equipment Course at the Picote Institute. Contact us for details on Picote In-House Lining Certification Training.

SAVE TIME AT THE JOB SITE

Want to move onto the next job?
The Picote Smart Heat Millers cure your CIPP liner up to 30% faster than ambient curing alone. In cold weather it can also be used to prepare pipes in advance of CIPP lining by warming the pipe.



CIPP LINING TOOLS

Lining Drums | Lining Cannons | Smart Roller | Smart Heat | Gluing Tools

Lining Cannon

Shoot liners from as small as 2" with the Picote Cannon. This compact and transparent installation tool is perfect for tight spaces where a drum won't fit for installing 2-6" liners. The Fast Lock System means you can move on to the next liner, shooting multiple lines in quick succession.

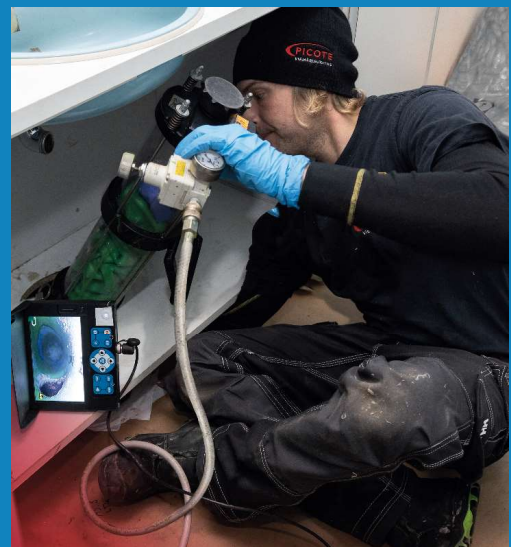



Picote Original Cannon

\$2,340.00

2360000001US

Cannon

A lightweight & transparent tool for short CIPP installations.
Includes 3 Inversion Heads (2,3,& 4") and 1 Fast Cap.



Picote Mini Cannon

\$2,160.00

2360000003US

Cannon

A lightweight & transparent tool for short CIPP installations.
Includes 3 Inversion Heads(2,3,& 4") and 1 Fast Cap.



Inversion Head 2"

\$95.00

900000504

Cannon Spare Part



Inversion Head 3"

\$106.00

900000505

Cannon Spare Part



Inversion Head 4"

\$117.00

900000506

Cannon Spare Part



Cannon Fast Cap

\$85.41

2360000004US

Cannon Spare Part

Used for curing multiple liners with one Cannon.



Picote Cannon Cap with Hole

\$38.60

900000759

Cannon Spare Part

Allows a CCTV camera to be pushed through the Cannon to view the liner before curing while still inflated.



Picote Cannon Cap

\$38.60

900000828
Cannon Spare Part

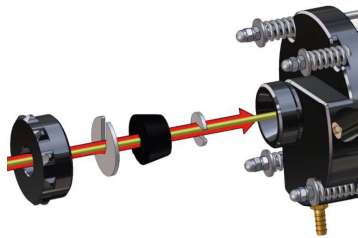

Cannon Air Sealing Package

\$15.20

900000923
Cannon Spare Part
Allows a CCTV camera to be pushed through the Cannon into the pipe.
View the inflated liner throughout the curing process!



Cannon Fast Cap with Smart Heat Cable Inlet US

\$232.50

2360000005US
Cannon Spare Part
Enables the use of Smart Heat Cable with Picote Cannon in order to make the curing process faster. Package includes both Mini and Maxi Smart Heat Cable gaskets.
Remove gasket to use as Standard Fast Cap without heating cable.



Air Pressure Regulator US

\$221.52

2340000001US
Connection Collar System
Use with Connection Collar Installation Tool, Picote Cannons & Picote Drums.



Mini Smart Heat Miller US

\$4,290.00

3410000000US
Smart Heat
Lightweight, portable and great value. Speed up ambient CIPP curing process up to 35%. Environmentally friendly option with no risk of water damage. No need for hot water or steam. Range: 46ft. Use with a Mini Smart Heat Curing Cap.



Maxi Smart Heat Miller US

\$9,945.00

3430000000US
Smart Heat
Lightweight, portable and great value. Speed up ambient CIPP curing process up to 35%. Environmentally friendly option with no risk of water damage. No need for hot water or steam. Range: 92ft. Use with a Maxi Smart Heat Curing Cap.



Smart Heat Cable 16ft

\$756.00

3430000005US
Smart Heat
Lightweight, portable and great value. Speed up ambient CIPP curing process up to 35%. Environmentally friendly option with no risk of water damage. No need for hot water or steam. Range: 16ft. Use with a Maxi Smart Heat Curing Cap.



Smart Heat Cable 32ft

\$1,044.00

3430000010US

Smart Heat

Lightweight, portable and great value. Speed up ambient CIPP curing process up to 35%. Environmentally friendly option with no risk of water damage. No need for hot water or steam. Range: 32ft. Use with a Maxi Smart Heat Curing Cap.



Mini Smart Heat Curing Cap 2" US

\$179.40

2340004050US

Smart Heat Spare Part

The Smart Heat Cable is pushed through Curing Cap to the liner.



Mini Smart Heat Curing Cap 3" US

\$210.60

2340004070US

Smart Heat Spare Part

The Smart Heat Cable is pushed through Curing Cap to the liner.



Mini Smart Heat Curing Cap 4" US

\$243.36

2340004100US

Smart Heat Spare Part

The Smart Heat Cable is pushed through Curing Cap to the liner.



Mini Smart Heat Curing Cap 6" US

\$269.00

2340004150US

Smart Heat Spare Part

The Smart Heat Cable is pushed through Curing Cap to the liner.



Maxi Smart Heat Curing Cap 2" US

\$187.20

2340005050US

Smart Heat Spare Part

The Smart Heat Cable is pushed through Curing Cap to the liner.



Maxi Smart Heat Curing Cap 3" US

\$221.52

2340005070US

Smart Heat Spare Part

The Smart Heat Cable is pushed through Curing Cap to the liner.



Maxi Smart Heat Curing Cap 4" US

\$257.40

2340005100US

Smart Heat Spare Part

The Smart Heat Cable is pushed through Curing Cap to the liner.



Maxi Smart Heat Curing Cap 6" US

\$279.00

2340005150US

Smart Heat Spare Part

The Smart Heat Cable is pushed through Curing Cap to the liner.



Curing Cap 2" US

\$110.01

2340000050US

Curing Tools

Use the curing cap to replace the drum/cannon to install multiple liners.



Curing Cap 3" US

\$120.54

2340000070US

Curing Tools

Use the curing cap to replace the drum/cannon to install multiple liners.



Curing Cap 4" US

\$156.34

2340000100US

Curing Tools

Use the curing cap to replace the drum/cannon to install multiple liners.



Curing Cap 6" US

\$233.27

2340000150US

Curing Tools

Use the curing cap to replace the drum/cannon to install multiple liners.



Curing Cap 8" US

\$322.34

2340000200US

Curing Tools

Use the curing cap to replace the drum/cannon to install multiple liners.



Liner Compressor 2.0 - 1 1/4" Pipe

\$210.00

2350050101

Curing Tools

Tightly lamps the end of the liner to prevent it collapsing from loss of pressure while you replace the inversion equipment with a Curing Cap.



Liner Compressor 2.0 - 6-8" Pipe

\$247.50

2350050200

Curing Tools

Tightly lamps the end of the liner to prevent it collapsing from loss of pressure while you replace the inversion equipment with a Curing Cap.



Picote Liner Glider

\$652.00

2380000000

Wet-Out Equipment

Manual roller for wetting out 2-4" liners. Comes equipped with easy to change color coded and size stamped gap setting rings for almost any liner thickness you may need.



Picote Smart Roller

\$2,985.00

2390000000

Wet-Out Equipment

Drill Powered roller for wetting out short 2-6" liners.



Liner Holder 2" Narrow for Smart Roller

\$180.00

2360101050

Smart Roller

For securing the liner while pouring resin. Custom designed for the Picote Smart Roller.



Liner Holder 3" Narrow for Smart Roller

\$187.00

2360101075

Smart Roller

For securing the liner while pouring resin. Custom designed for the Picote Smart Roller.



Liner Holder 4" Narrow for Smart Roller

\$195.00

2360101100

Smart Roller

For securing the liner while pouring resin. Custom designed for the Picote Smart Roller.



Liner Holder 6" Narrow for Smart Roller

\$202.00

2360101150

Smart Roller

For securing the liner while pouring resin. Custom designed for the Picote Smart Roller.



Picote Manual Roller

\$6,480.00

2300000001

Wet-Out Equipment

Manual roller for wetting out 2-10" liners.



Picote Inversion Drum 350 US

\$5,451.00

2300000350US

Inversion Drum

Pipe Range: 2-6"

Weight: 31 lbs. 17"(W)x22"(L)x19"(H)

Liner Capacity: 30ft (of 6" dry Liner with straight winding and without resin).



Picote Inversion Drum 500 US

\$8,354.00

2300000500US

Inversion Drum

Pipe Range: 2-8"

Weight: 84lbs. 25"(W)x34"(L)x44"(H).

Liner Capacity: 59ft (of 6" dry Liner with straight winding and without resin).



Picote Inversion Drum 700 US

\$9,591.00

2300000700US

Inversion Drum

Pipe Range: 2-10"

Weight 110lbs. 28"(W)x36"(L)x47"(H)

Liner Capacity: 125ft (of 6" dry Liner with straight winding and without resin).



Picote Inversion Drum 700 Slim US

\$11,773.00

2300000701US

Inversion Drum

Pipe Range: 2-10"

Weight 130lbs. Without wheel stand 110lbs. 23"(W)x39"(L)x45"(H).

Liner Capacity: 125ft (of 6" dry Liner with straight winding and without resin).



Picote Inversion Drum 900 US

\$15,958.00

2300000900US

Inversion Drum

Pipe Range: 2-12"

Weight 176lbs. 32"(W)x47"(L)x50"(H).

Liner Capacity: 125ft (of 9" dry Liner with straight winding and without resin).



Inversion Tank Key (Storz Wrench)

\$65.66

2300000002
Inversion Drum spare part



Inversion Head 2" Straight

\$383.00

2301000050
Inversion Head for Drum



Inversion Head 3" Straight

\$616.00

2301000075
Inversion Head for Drum



Inversion Head 4" Straight

\$569.00

2301000100
Inversion Head for Drum



Inversion Head 6" Straight

\$569.00

2301000150
Inversion Head for Drum



Inversion Head 3" Elbow 45° (Use with Head Reducer)

\$556.00

2302000075
Inversion Head for Drum
Use with Head Reducer.



Inversion Head 4" Elbow 45° (Use with Head Reducer)

\$556.00

2302000100
Inversion Head for Drum
Use with Head Reducer.



Inversion Head 6" Elbow 45°

\$713.00

2302000150
Inversion Head for Drum



Inversion Head 3" Elbow 90° (Use with Head Reducer)

\$556.00

2305000075
Inversion Head for Drum
Use with Head Reducer.



Inversion Head 4" Elbow 90° (Use with Head Reducer)

\$556.00

2305000100
Inversion Head for Drum
Use with Head Reducer.



Inversion Head 6" Elbow 90°

\$713.00

2305000150
Inversion Head for Drum



Inversion Head 3" with Steam Connection

\$734.00

2306000075
Inversion Head for Drum
Comes with a steam connection.



Inversion Head 4" with Steam Connection

\$734.00

2306000100
Inversion Head for Drum
Comes with a steam connection.



Inversion Head 6" with Steam Connection

\$772.00

2306000150
Inversion Head for Drum
Comes with a steam connection.



Inversion Head Reducer 4-6"

\$609.00

2300000003
Inversion Head for Drum



Liner Holder 2" Standard

\$148.20

2360001050
Liner Holder
Safely secures the liner for pouring resin into the liner during wet-out.



Liner Holder 3" Standard

\$156.00

2360001075
Liner Holder
Safely secures the liner for pouring resin into the liner during wet-out.



Liner Holder 4" Standard

\$163.80

2360001100
Liner Holder
Safely secures the liner for pouring resin into the liner during wet-out.



Liner Holder 6" Standard

\$171.60

2360001150
Liner Holder
Safely secures the liner for pouring resin into the liner during wet-out.



Gluing Tool 2" US

\$399.00

1320050050US
Preparation for Open Ended Liners
For gluing open-end calibration tube to liner.



Gluing Tool 2-3"/One Size 3" US

\$460.20

1320050070US
Preparation for Open Ended Liners
For gluing open-end calibration tube to liner.



Gluing Tool 3-4\"/>

\$510.12

1320070100US

Preparation for Open Ended Liners
For gluing open-end calibration tube to liner.



Gluing Tool 4-6\"/>

\$553.80

1320100150US

Preparation for Open Ended Liners
For gluing open-end calibration tube to liner.



Gluing Tool 6-8\"/>

\$603.72

1320150200US

Preparation for Open Ended Liners
For gluing open-end calibration tube to liner.



Picote Branch Lining Glue 1L

\$101.25

1320001001

Preparation for Open Ended Liners
Glue used for calibration hose and liner in open-end lining process.
Can be used with steam up to 140 °F.



Brush for Gluing

\$3.00

2300000004

Preparation for Open Ended Liners



Steel Tie Gun

\$292.00

900000600

Preparation for Open Ended Liners



Stainless Steel Cable Tie

\$20.25

900000601

Preparation for Open Ended Liners
Includes 100pcs.



Connection Collar Installation Tool Head

\$154.05

141000002

Connection Collar System

For insertion of connection collars into the pipe connection.

Purchase multiple tool heads and preassemble bladders on them.



Connection Collar Installation Tool 16.4ft

\$499.00

141000005

Connection Collar System

Includes one Installation Tool Head.



Connection Collar Installation Tool 32.8ft

\$577.00

141000010

Connection Collar System

Includes one Installation Tool Head.



Connection Collar Installation Tool 49.2ft

\$670.00

141000015

Connection Collar System

Includes one Installation Tool Head.



Regulator and Vacuum Assembly US

\$472.50

141000001US

Connection Collar System

For Vacuum and installation of Connection Collars.



Vacuum US

\$246.00

141000000US

Connection Collar System

For Vacuum and installation of Connection Collars.



Hose Clamp 1-1.5"

\$4.88

950000384

Connection Collar System

For attaching Bladder to the Installation Tool Head.



Hose Clamp 1.25-1.75"

\$5.63

950000385

Connection Collar System

For attaching Bladder to the Installation Tool Head.

INSTALL T OR Y CONNECTION COLLARS WITH EASE

Easily and quickly install T and Y connection collars at the job site with Picote's customized installation tool for 3" to 6" pipes. This flexible system offers all parts needed (Installation Tool & Head, Bladder & Connection Collars). The innovative Installation Tool allows the use of compressed air for the installation process.

Available in 3 lengths: 16.4ft, 32.8ft. & 49.2ft.



Since 2013 there have been over 40,000 successful installations of T and Y Picote Connection Collars, which are hand-made in Finland.

CONNECTION COLLARS & BLADDERS

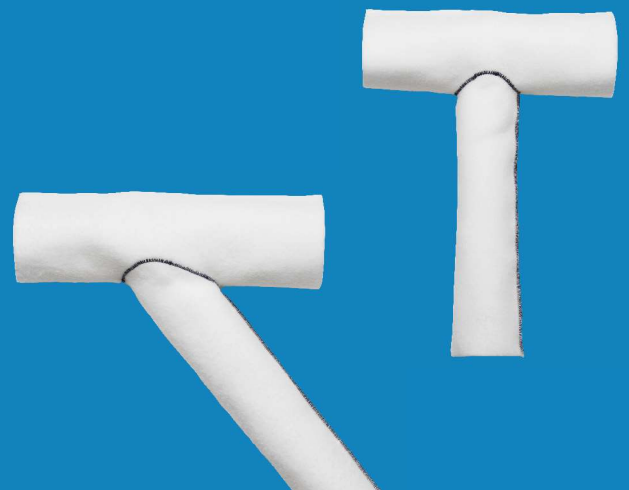
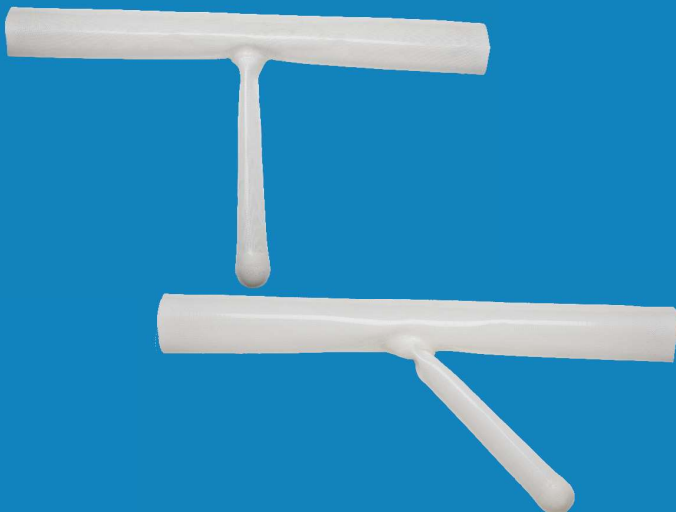



Connection Collars

1411007050T 3"½" T	\$ 68.56
1411007050Y 3"½" Y	\$ 68.56
1411007070T 3"⅓" T	\$ 70.12
1411007070Y 3"⅓" Y	\$ 70.12
1411010050T 4"½" T	\$ 70.98
1411010050Y 4"½" Y	\$ 70.98
1411010070T 4"⅓" T	\$ 71.53
1411010070Y 4"⅓" Y	\$ 71.53
1411100100T 4"¼" T	\$ 72.70
1411100100Y 4"¼" Y	\$ 72.70
1411125050T 5"½" T	\$ 71.99
1411125050Y 5"½" Y	\$ 71.99
1411125070T 5"⅓" T	\$ 72.62
1411125070Y 5"⅓" Y	\$ 72.62
1411125100T 5"¼" T	\$ 73.55
1411125100Y 5"¼" Y	\$ 73.55
1411125125T 5"⅕" T	\$ 75.11
1411125125Y 5"⅕" Y	\$ 75.11
1411150050T 6"½" T	\$ 73.09
1411150050Y 6"½" Y	\$ 73.09
1411150070T 6"⅓" T	\$ 73.71
1411150070Y 6"⅓" Y	\$ 73.71
1411150100T 6"¼" T	\$ 75.27
1411150100Y 6"¼" Y	\$ 75.27
1411150125T 6"⅕" T	\$ 76.05
1411150125Y 6"⅕" Y	\$ 76.05
1411150150T 6"⅙" T	\$ 76.83
1411150150Y 6"⅙" Y	\$ 76.83



Picote Bladders

1410007050Y 3"½" Y	\$ 336.96
1410007070T 3"⅓" T	\$ 336.96
1410007070Y 3"⅓" Y	\$ 336.96
1410010050T 4"½" T	\$ 341.64
1410010050Y 4"½" Y	\$ 341.64
1410010070T 4"⅓" T	\$ 341.64
1410010070Y 4"⅓" Y	\$ 341.64
1410100100T 4"¼" T	\$ 341.64
1410100100Y 4"¼" Y	\$ 341.64
1410150070T 6"⅓" T	\$ 351.00
1410150070Y 6"⅓" Y	\$ 351.00
1410150100T 6"¼" T	\$ 351.00
1410150100Y 6"¼" Y	\$ 351.00
1410150150T 6"⅙" T	\$ 351.00
1410150150Y 6"⅙" Y	\$ 351.00

NEW
TIGER TWISTER

The Tiger Twister is a fast and efficient lateral cutter that produces a clean, impressive reinstatement every time, especially with fiberglass liners and UV resins. It has a precision manufactured milling plate equipped with the specially hardened Tiger carbides.

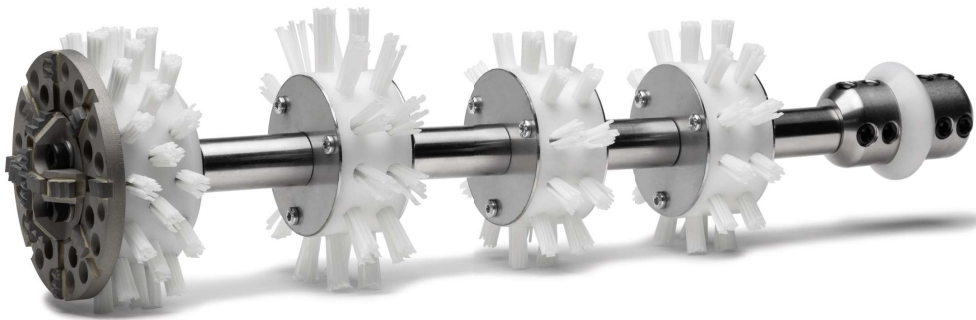

TWISTER LATERAL CUTTERS

TWISTER MINI FLEXI

Open lateral connections fast,
even through P-traps or multiple bends.

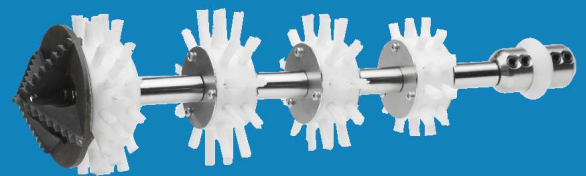

TAKE THE EXPRESS WAY

The Picote Twister Express is a fast and highly efficient way to open lateral connections, making an impressive first opening. Follow with the Smart Cutter™ for fine tuning.

Twister Mini Flexi 2" - 1/3" Shaft

\$682.50



1230000054

Lateral Cutter (1/3" Shaft)

For reinstatements through problematic bends, multiple bends or P-traps.
Spare Drill Head: 1230000053.

Twister Express 2" - 1/3" Shaft

\$731.00



1230000052

Lateral Cutter (1/3" Shaft)

Time is money. Our fastest option for reinstating lined connections with an impressive initial opening inside cast iron, clay, concrete or PVC pipes.
Spare Drill Head: 1230000053.

Twister Mini Flexi 3" - 1/3" Shaft

\$766.50



1230000074

Lateral Cutter (1/3" Shaft)

For reinstatements through problematic bends, multiple bends or P-traps.
Spare Drill Head: 1230000073.

Twister Express 3" - 1/3" Shaft

\$795.00



1230000072

Lateral Cutter (1/3" Shaft)

Time is money. Our fastest option for reinstating lined connections with an impressive initial opening inside cast iron, clay, concrete or PVC pipes.
Spare Drill Head: 1230000073.

Twister Express 3" Unlined Pipe - 1/2" Shaft

\$845.00



1230000371

Lateral Cutter (1/2" Shaft)

Time is money. Our fastest option for reinstating lined connections with an impressive initial opening inside cast iron, clay, concrete or PVC pipes.
Spare Drill Head: 900000987.

Twister Express 3" Lined Pipe - 1/2" Shaft

\$881.00



1230000471

Lateral Cutter (1/2" Shaft)

Time is money. Our fastest option for reinstating lined connections with an impressive initial opening inside cast iron, clay, concrete or PVC pipes.
Spare Drill Head: 900000988.

Twister Express 4" for Lined Pipe - 1/2" Shaft

\$998.00

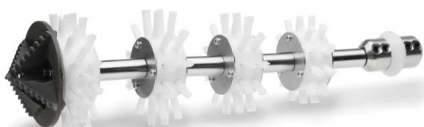

1233075102

Lateral Cutter (1/2" Shaft)

Time is money. Our fastest option for reinstating lined connections with an impressive initial opening inside cast iron, clay, concrete or PVC pipes.
Front Drill Head size: 3" Spare Drill Head: 1300214075.

Twister Express 4" for Unlined Pipe - 1/2" Shaft

\$1,052.00

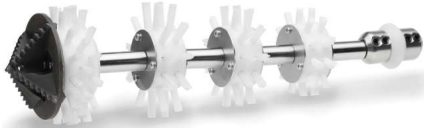

1233085102

Lateral Cutter (1/2" Shaft)

Time is money. Our fastest option for reinstating lined connections with an impressive initial opening inside cast iron, clay, concrete or PVC pipes.

Front Drill Head size: 3.3" Spare Drill Head: 1300214085.

Tiger Twister Lateral Cutter for 4" Lined

\$1,125.00



1262075100

Lateral Cutter (1/2" Shaft)

Reinstate connections even with Fiberglass Liners & UV Resins, creating an impressive initial opening. Features a precision Front Metal Panel and Front Drill Head equipped with extra-hard Tiger carbides. Front Metal Panel: 3", thickness 6mm (1260000075).

Tiger Twister Lateral Cutter 4" Unlined

\$1,125.00



1262085100

Lateral Cutter (1/2" Shaft)

Reinstate connections even with Fiberglass Liners & UV Resins, creating an impressive initial opening. Features a precision Front Metal Panel and Front Drill Head equipped with extra-hard Tiger carbides. Front Metal Panel: 3.3", thickness 6mm (1260000085).

Tiger Twister Lateral Cutter for 5" Lined

\$1,147.50

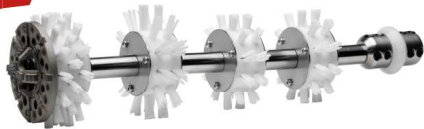

1262090125

Lateral Cutter (1/2" Shaft)

Reinstate connections even with Fiberglass Liners & UV Resins, creating an impressive initial opening. Features a precision Front Metal Panel and Front Drill Head equipped with extra-hard Tiger carbides. Front Metal Panel: 3.5", thickness 6mm (1260000090).

Tiger Twister Lateral Cutter 5" Unlined

\$1,147.50



1262100125

Lateral Cutter (1/2" Shaft)

Reinstate connections even with Fiberglass Liners & UV Resins, creating an impressive initial opening. Features a precision Front Metal Panel and Front Drill Head equipped with extra-hard Tiger carbides. Front Metal Panel: 4", thickness 6mm (1260000100).

Tiger Twister Lateral Cutter 6" Lined

\$1,192.50

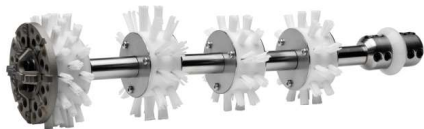

1262115150

Lateral Cutter (1/2" Shaft)

Reinstate connections even with Fiberglass Liners & UV Resins, creating an impressive initial opening. Features a precision Front Metal Panel and Front Drill Head equipped with extra-hard Tiger carbides. Front Metal Panel: 4.5", thickness 6mm (1260000115).

Tiger Twister Lateral Cutter 6" Unlined

\$1,192.50



1262125150

Lateral Cutter (1/2" Shaft)

Reinstate connections even with Fiberglass Liners & UV Resins, creating an impressive initial opening. Features a precision Front Metal Panel and Front Drill Head equipped with extra-hard Tiger carbides. Front Metal Panel: 5", thickness 6mm (1260000125).



Tiger Twister Lateral Cutter for 8" Unlined Pipe

\$1,312.50

1262175200

Lateral Cutter (1/2" Shaft)

Reinstate connections even with Fiberglass Liners & UV Resins, creating an impressive initial opening. Features a precision Front Metal Panel and Front Drill Head equipped with extra-hard Tiger carbides. Front Metal Panel: 7", thickness 6mm (1260000175).

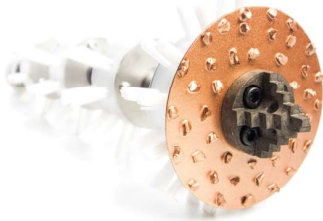

Twister 4" for Lined Pipe - 1/2" Shaft

\$1,099.80

1230075100Y

Lateral Cutter (1/2" Shaft)

Front Metal Panel: 3", thickness 1mm. (1210310075)

Reinstatements inside clay, cast iron, concrete or plastic pipes. Brushes keep tool centered in the pipe. Includes spare 3mm Front Metal Panel.

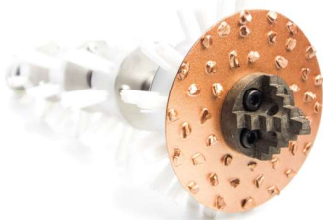

Twister 4" for Unlined Pipe - 1/2" Shaft

\$1,099.80

1230085100Y

Lateral Cutter (1/2" Shaft)

Front Metal Panel: 3.3", thickness 1mm. (1210310085).

Reinstatements inside clay, cast iron, concrete or plastic pipes. Brushes keep tool centered in the pipe. Includes spare 3mm Front Metal Panel.

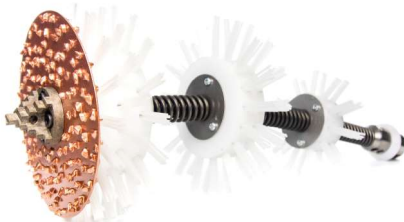

Twister 6" for Lined Pipe - 1/2" Shaft

\$1,209.00

1230115150Y

Lateral Cutter (1/2" Shaft)

Front Metal Panel: 4.5", thickness 1mm. (1210310115).

Reinstatements inside clay, cast iron, concrete or plastic pipes. Brushes keep tool centered in the pipe. Includes spare 3mm Front Metal Panel.

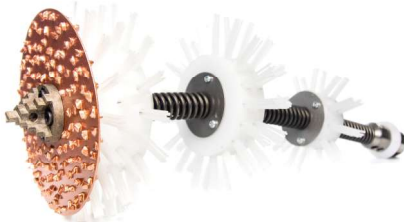

Twister 6" for Unlined Pipe - 1/2" Shaft

\$1,209.00

1231125150Y

Lateral Cutter (1/2" Shaft)

Front Metal Panel: 5", thickness 1mm. (1210310125).

Reinstatements inside clay, cast iron, concrete or plastic pipes. Brushes keep tool centered in the pipe. Includes spare 3mm Front Metal Panel.



Twister 8" - 1/2" Shaft

\$1,482.00

1230175200Y

Lateral Cutter (1/2" Shaft)

Front Metal Panel: 7", thickness 1mm. (1210310175).

Reinstatements inside clay, cast iron, concrete or plastic pipes. Brushes keep tool centered in the pipe. Includes spare 3mm Front Metal Panel.



WIPE OUT THE COMPETITION!

Special Drill Heads can easily cut into tough blockages such as tree roots, grease, heavy scale, or tuberculation and can be used to unblock pipes in order to make space for larger tools to follow.

Special Drill Heads can be attached in front of Picote Original Grinding Chains to create an initial opening in the blockage to then allow the chains to open and better perform their cleaning function.

They can also be used to create an initial CIPP connection opening in pipes when larger tools like the Twister cannot fit, or where a Front Drill Head and Front Panel cannot be attached to a Smart Cutter™.

 Check out our video on Drill Heads at: [YouTube.com/PicoteSolutions](https://www.youtube.com/PicoteSolutions)

SPECIAL DRILL HEADS & TIGER BORES

The **Tiger Bore** is highly efficient at reinstating lined connections and opening up blockages. It is also effective for cutting through collapsed liners to make room for larger removal tools to follow as well as for removing grout & concrete in small diameter pipes.

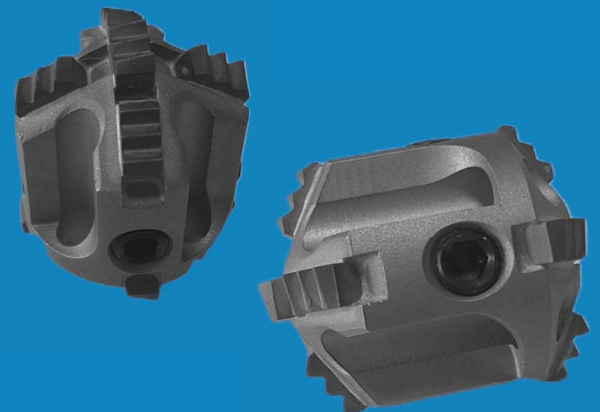

(S) = Shaft Size (D) = Diameter (L) = Length



Special Drill Head Cutter for 1.25-1.5" Pipe - 1/3" Shaft

\$209.40

1310820029

Reinstatements & Cleaning (1/3" Shaft)

For use in cast iron pipes for initial liner opening and blockages. Square design/side blades allow the cutter to tumble on obstacles/connections to make hole larger than physical size of drill head. Measurement: .33(S)x.8(D)x1.14(L).



Special Drill Head Cutter for 2" Pipe - 1/3" Shaft

\$226.36

1310820042

Reinstatements & Cleaning (1/3" Shaft)

For use in cast iron pipes for initial liner opening and blockages. Square design/side blades allow the cutter to tumble on obstacles/connections to make hole larger than physical size of drill head. Measurement: .33(S)x.79(D)x1.6(L).



Special Drill Head Cutter for 2-3" Pipe - 1/3" Shaft

\$247.65

1310830055

Reinstatements & Cleaning (1/3" Shaft)

For use in cast iron pipes for initial liner opening and blockages. Square design/side blades allow the cutter to tumble on obstacles/connections to make hole larger than physical size of drill head. Measurement: .33(S)x1.2(D)x2.2(L).



Special Drill Head Cutter for 3" Pipe - 1/2" Shaft

\$260.75

1311230055

Reinstatements & Cleaning (1/2" Shaft)

For use in cast iron pipes for initial liner opening and blockages. Square design/side blades allow the cutter to tumble on obstacles/connections to make hole larger than physical size of drill head. Measurement: .5(S)x1.2(D)x2.2(L).



Special Drill Head Cutter for 3" Pipe - 1/2" Shaft

\$271.21

1311240071

Reinstatements & Cleaning (1/2" Shaft)

For use in cast iron pipes for initial liner opening and blockages. Square design/side blades allow the cutter to tumble on obstacles/connections to make hole larger than physical size of drill head. Measurement: .5(S)x1.6(D)x2.8(L).



Special Drill Head Cutter for 3-4" Pipe - 1/2" Shaft

\$283.06

1311250091

Reinstatements & Cleaning (1/2" Shaft)

For use in cast iron pipes for initial liner opening and blockages. Square design/side blades allow the cutter to tumble on obstacles/connections to make hole larger than physical size of drill head. Measurement: .5(S)x2(D)x3.6(L).



Special Drill Head Cutter 2.0 for 2-3" Pipe - 1/3" Shaft

\$238.13

1310833055

Reinstatements & Cleaning (1/3" Shaft)

Similar features to the Standard Cutter but works better for cutting through soft materials. Drill head stays sharper when used for reinstatements. Measurement: .33(S)x1.2(D)x2.2(L).

(S) = Shaft Size (D) = Diameter (L) = Length

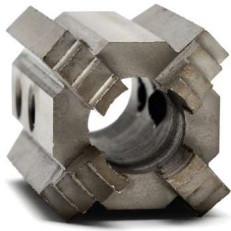

Special Drill Head Cutter 2.0 for 3" Pipe - 1/2" Shaft

\$250.73

1311233055

Reinstatements & Cleaning (1/2" Shaft)

Similar features to the Standard Cutter but works better for cutting through soft materials.

Drill head stays sharper when used for reinstatements.

Measurement: .5(S)x1.2(D)x2.2(L).



Special Drill Head Cutter 2.0 for 3-4" Pipe - 1/2" Shaft

\$295.88

1311234071

Reinstatements & Cleaning (1/2" Shaft)

Similar features to the Standard Cutter but works better for cutting through soft materials.

Drill head stays sharper when used for reinstatements.

Measurement: .5(S)x1.6(D)x2.8(L).



Special Drill Head Cutter 2.0 for 3-4" Pipe - 1/2" Shaft

\$272.18

1311235091

Reinstatements & Cleaning (1/2" Shaft)

Similar features to the Standard Cutter but works better for cutting through soft materials.

Drill head stays sharper when used for reinstatements.

Measurement: .5(S)x2(D)x3.6(L).



Special Drill Head PVC for 1.25-1.5" Pipe - 1/3" Shaft

\$236.73

1310812029

Reinstatements & Cleaning (1/3" Shaft)

Drill head with safety ring to safely operate inside PVC & clay pipes and make initial cut.

Measurement: .33(S)x.9(D)x1.14(L).



Special Drill Head PVC for 2" Pipe - 1/3" Shaft

\$260.68

1310812042

Reinstatements & Cleaning (1/3" Shaft)

Drill head with safety ring to safely operate inside PVC & clay pipes and make initial cut.

Measurement: .33(S)x.9(D)x1.6(L).



Special Drill Head PVC for 2-3" Pipe - 1/3" Shaft

\$281.19

1310813055

Reinstatements & Cleaning (1/3" Shaft)

Drill head with safety ring to safely operate inside PVC & clay pipes and make initial cut.

Measurement: .33(S)x1.3(D)x2.2(L).



Special Drill Head PVC for 3" Pipe - 1/2" Shaft

\$295.31

1311213055

Reinstatements & Cleaning (1/2" Shaft)

Drill head with safety ring to safely operate inside PVC & clay pipes and make initial cut.

Measurement: .5(S)x1.2(D)x2.2(L).

(S) = Shaft Size (D) = Diameter (L) = Length



Special Drill Head PVC for 3" Pipe - 1/2" Shaft

\$307.71

1311214071

Reinstatements & Cleaning (1/2" Shaft)

Drill head with safety ring to safely operate inside PVC & clay pipes and make initial cut.

Measurement: .5(S)x1.6(D)x2.8(L).



Special Drill Head PVC for 3-4" Pipe - 1/2" Shaft

\$335.63

1311215091

Reinstatements & Cleaning (1/2" Shaft)

Drill head with safety ring to safely operate inside PVC & clay pipes and make initial cut.

Measurement: .5(S)x2(D)x3.6(L).



Special Drill Head 3D for 2-3" Pipe - 1/3" Shaft

\$228.93

1310823055

Reinstatements(1/3" Shaft)

3D model has reverse angled cutting edges allowing the drill head to be pulled backwards to enlarge initial opening made by smaller standard Special Drill Head/Bore.

Measurement: .33(S)x1.2(D)x2.2(L).



Special Drill Head 3D for 3" Pipe - 1/2" Shaft

\$239.07

1311223055

Reinstatements (1/2" Shaft)

3D model has reverse angled cutting edges allowing the drill head to be pulled backwards to enlarge initial opening made by smaller standard Special Drill Head/Bore.

Measurement: .5(S)x1.2(D)x2.2(L).



Special Drill Head 3D for 3" Pipe - 1/2" Shaft

\$253.11

1311224071

Reinstatements (1/2" Shaft)

3D model has reverse angled cutting edges allowing the drill head to be pulled backwards to enlarge initial opening made by smaller standard Special Drill Head/Bore.

Measurement: .5(S)x1.6(D)x2.8(L).



Special Drill Head 3D for 3-4" Pipe - 1/2" Shaft

\$279.16

1311225091

Reinstatements (1/2" Shaft)

3D model has reverse angled cutting edges allowing the drill head to be pulled backwards to enlarge initial opening made by smaller standard Special Drill Head/Bore.

Measurement: .5(S)x2(D)x3.6(L).



Tiger Bore (1.2") for 2" pipe - 1/3" Shaft

\$253.50

1261084030

Reinstatements & Cleaning (1/3" Shaft)

Highly efficient at reinstating lined connections and opening up blockages. Cut through collapsed liners to make room for larger removal tools. Remove grout & concrete.

Tiger carbides ensure maximum working efficiency, durability, and power.

(S) = Shaft Size (D) = Diameter (L) = Length



Tiger Bore (1.5") for 2-3" Pipe - 1/3" Shaft

\$262.50

1261084040

Reinstatements & Cleaning (1/3" Shaft)

Highly efficient at reinstating lined connections and opening up blockages. Cut through collapsed liners to make room for larger removal tools. Remove grout & concrete. Tiger carbides ensure maximum working efficiency, durability, and power.



Tiger Bore (1.2") for 3" Pipe - 1/2" Shaft

\$259.50

1261125030

Reinstatements & Cleaning (1/2" Shaft)

Highly efficient at reinstating lined connections and opening up blockages. Cut through collapsed liners to make room for larger removal tools. Remove grout & concrete. Tiger carbides ensure maximum working efficiency, durability, and power.



Tiger Bore (1.5") for 3" Pipe - 1/2" Shaft

\$274.50

1261125040

Reinstatements & Cleaning (1/2" Shaft)

Highly efficient at reinstating lined connections and opening up blockages. Cut through collapsed liners to make room for larger removal tools. Remove grout & concrete. Tiger carbides ensure maximum working efficiency, durability, and power.



Tiger Bore (2") for 3-4" Pipe - 1/2" Shaft

\$283.50

1261125050

Reinstatements & Cleaning (1/2" Shaft)

Highly efficient at reinstating lined connections and opening up blockages. Cut through collapsed liners to make room for larger removal tools. Remove grout & concrete. Tiger carbides ensure maximum working efficiency, durability, and power.

SMARTER THAN YOU THINK!

The patented Picote Smart Cutter™ is a truly groundbreaking and versatile tool that has changed the trenchless industry worldwide. Originally created as a lateral reinstatement cutter for inside buildings, the Smart Cutter™ is also suitable for cleaning pipes from 1 1/4" to 12". Want more? The Smart Cutter™ is a great tool to remove remaining concrete or failed CIPP lining from the edges of a pipe and is even available for the Maxi Power+ machine.



The **ORIGINAL**
and still the **BEST**

SMART CUTTER™



CUT | CLEAN | REFINE

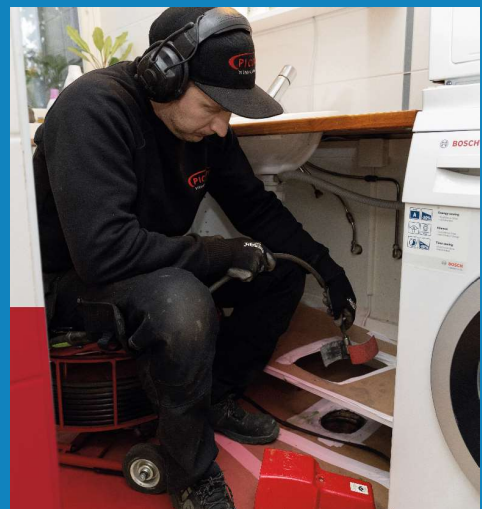



Hub .47x1" for 1 1/4" Pipe - 1/4" Shaft No Wedge

\$81.51

1000612025

2 Panel Hub with No Wedge (1/4" Shaft)

Use with Side Grinding Panels with no wedge (1202040060 & 1202050100).

Measurement: .25(S)x.47(D)x.98(L).



Hub .6x1" for 1 1/4" Pipe - 1/4" Shaft No Wedge

\$82.60

1000615025

2 Panel Hub with No Wedge (1/4" Shaft)

Use with Side Grinding Panels with no wedge (1202040060 & 1202050100).

Measurement: .25(S)x.59(D)x1(L).



Hub .6x1.18" for 1 1/4" Pipe - 1/4" Shaft No Wedge

\$83.85

1000615030

2 Panel Hub with No Wedge (1/4" Shaft)

Use with Side Grinding Panels with no wedge (1202040060 & 1202050100).

Measurement: .25(S)x.6(D)x1.18(L).



Hub 1 1/4"-1.57" for 1/3" Shaft No Wedge

\$42.98

1000818025

2 Panel Hub with No Wedge (1/3" Shaft)

Use with Side Grinding Panels with no wedge (1202040060 & 1202050100).

Measurement: .33(S)x.7(D)x.98(L).



Hub .8x1.57" for 2" Pipe - 1/3" Shaft No Wedge

\$85.41

1000820040

2 Panel Hub with No Wedge (1/3" Shaft)

Use with Side Grinding Panels with no wedge (1202040060 & 1202050100).

Measurement: .33(S)x.79(D)x1.57(L).



Hub .8x2.36" for 2-3" Pipe - 1/3" Shaft No Wedge

\$85.80

1000820060

2 Panel Hub with No Wedge (1/3" Shaft)

Use with Side Grinding Panels with no wedge (1202040060 & 1202050100).

Measurement: .33(S)x.79(D)x2.36(L).



Hub .8x1.57" for 2" Pipe - 3/8" Shaft No Wedge

\$85.41

1001020040

2 Panel Hub with No Wedge (3/8" Shaft)

Use with Side Grinding Panels with no wedge (1202040060 & 1202050100).

Measurement: .39(S)x.79(D)x1.57(L).



Hub .8x2.36" for 3" Pipe - 3/8" Shaft No Wedge

\$85.80

1001020060

2 Panel Hub with No Wedge (3/8" Shaft)
Use with Side Grinding Panels with no wedge (1202040060 & 1202050100).
Measurement: .39(S)x.79(D)x2.36(L).



Hub 2" Narrow 2W for 2-3" Pipe - 1/3" Shaft

\$85.80

1000820050

2 Panel Hub with Wedge (1/3" Shaft)
2" pipe. Use with Side Grinding Panel 2x4" & Hub Disc 2W.
Measurement: .33(S)x.8(D)x2(L).



Hub 3" Narrow 2W for 4" Pipe - 1/3" Shaft

\$88.92

1000820075

2 Panel Hub with Wedge (1/3" Shaft)
3" pipe. Use with Side Grinding Panel 3x5" & Hub Disc 2W.
Measurement: .33(S)x.8(D)x3(L).



Hub 2" Narrow 2W for 2-3" Pipe - 3/8" Shaft

\$85.80

1001020050

2 Panel Hub with Wedge (3/8" Shaft)
2" pipe. Use with Side Grinding Panel 2x4" & Hub Disc 2W.
Measurement: .39(S)x.8(D)x2(L).



Hub 3" Narrow 2W for 4" Pipe - 3/8" Shaft

\$88.92

1001020075

2 Panel Hub with Wedge (3/8" Shaft)
3" pipe. Use with Side Grinding Panel 3x5" & Hub Disc 2W.
Measurement: .39(S)x.8(D)x3(L).



Hub 3" Short for 3-4" Pipe - 1/3" Shaft

\$85.80

1000835050A

4 Panel Hub with Wedge (1/3" Shaft)
3-4" pipe. 1/3" shaft. Use with Side Grinding Panel 2x4" with wedge & Hub Disc 2W (diameter 1.4"). Material: Aluminum.
Measurement: .33(S)x1.4(D)x2(L).



Hub 3" Short for 3-4" Pipe - 3/8" Shaft

\$85.80

1001035050A

4 Panel Hub with Wedge (3/8" Shaft)
3-4" pipe. 1/3" shaft. Use with Side Grinding Panel 2x4" with wedge & Hub Disc 2W (diameter 1.4"). Material: Aluminum.
Measurement: .39(S)x1.4(D)x2(L).



Hub 3" Short for 3-4" Pipe - 1/2 Shaft

\$85.80

1001235050A

4 Panel Hub with Wedge (1/2" Shaft)
3-4" pipe. 1/2" shaft. Uses Side Grinding Panel 2-4" with wedge & Hub Disc S.
Material: Aluminum.
Measurement: .5(S)x1.4(D)x2(L).



Hub 3" for 3-4" Pipe - 1/2 Shaft

\$93.60

1001235075A

4 Panel Hub with Wedge (1/2" Shaft)
3-4" pipe. Uses Side Grinding Panel 3x5" with wedge & Hub Disc S.
Material: Aluminum.
Measurement: .5(S)x1.4(D)x3(L).



Hub 4" for 4-6" Pipe - 1/2 Shaft

\$101.40

1001240100A

4 Panel Hub with Wedge (1/2" Shaft)
4-6" pipe. Uses Side Grinding Panel 4x6" & Hub Disc L.
Material: Aluminum.
Measurement: .5(S)x1.6(D)x4(L).



Hub 6" for 6-8" Pipe - 1/2 Shaft

\$109.20

1001240150A

4 Panel Hub with Wedge (1/2" Shaft)
6-8" pipe. Uses Side Grinding Panel 6"x8" & Hub Disc L.
Material: Aluminum.
Measurement: .5(S)x1.6(D)x6(L).



Hub 8" for 8" Pipe - 1/2 Shaft

\$115.44

1001240200A

4 Panel Hub with Wedge (1/2" Shaft)
8" pipe. Uses Side Grinding Panel 8"x10" & Hub Disc L.
Material: Aluminum.
Measurement: .5(S)x1.6(D)x8(L).



Hub 4-6" (6-Panel) - 1/2 Shaft

\$384.72

1001250100A

6 Panel Hub with Wedge (1/2" Shaft)
For 4-6" pipe. Includes Hub Disc XL. Use with Side Grinding Panel 4x4" (4") or 4x6" (6").
Measurement: .5(S)x2(D)x4(L).



Hub 6-8" (6 Panel) - 1/2 Shaft

\$482.82

1001250150A

6 Panel Hub with Wedge (1/2" Shaft)
For 6-8" pipe. Includes Hub Disc (XL). Use with Side Grinding Panel 6x6" (6") or 6x8" (8").
Measurement: .5(S)x2(D)x6(L).



Wedged Hub Disc - 2W

\$13.65

1000200020

Hub Disc
Hub Disc 2W (.8" diameter) for 2 Panel Hubs.



Hub Disc Small

\$19.88

1000200035

Hub Disc
Hub Disc S (1.4" diameter) for 4 Panel Hubs Ø1.4".



Hub Disc Large

\$19.88

1000200040

Hub Disc
Hub Disc L (1.6" diameter) for 4 Panel Hubs Ø1.6".



Hub Disc XL (6-panel)

\$31.84

1000200050

Hub Disc
Hub Disc XL (2" diameter) for 6 Panel Hubs.



Steering Hub Disc Small

\$19.88

1000210035

Hub Disc
Steering Hub Disc S (diameter 1.4").
Used with the Steering Axle for 4 Panel Hubs Ø1.4".



Steering Hub Disc Large

\$19.88

1000210040

Hub Disc
Steering Hub Disc S (diameter 1.6").
Used with the Steering Axle for 4 Panel Hubs Ø1.6".



Screws for Hub Disc

\$33.52

1350000100

Hub Disc Spare Part
Package of 12.
Specify which disc size when ordering.



Steering Axle 2.17"

\$57.41

1100100055
Hub Disc Accessories
For fine-tuning or steering tools.



Bearing for Steering Axle

\$10.57

1100200001
Hub Disc Accessories
Use with Steering Axle.



Smart Steering Guide 4-6" with Bearing

\$402.78

1312024125
Hub Accessories
A precision fine-tuning tool that attaches to the Smart Cutter™ Hub allowing the user to steer the Hub without damaging the lined pipe during the reinstatement process.



Smart Steering Guide 6-8" with Bearing

\$468.54

1312025125
Hub Accessories
A precision fine-tuning tool that attaches to the Smart Cutter™ Hub allowing the user to steer the Hub without damaging the lined pipe during the reinstatement process.



Counter Weight - Small

\$54.10

1100500040
Hub Accessories
Fine-tuning tool used to pull Hub downward to remove bottom lip of the liner.



Counter Weight - Large

\$62.95

1100500060
Hub Accessories
Fine-tuning tool used to pull Hub downward to remove bottom lip of the liner.



Steering Wire 328 ft.

\$170.08

1350150405
Hub Accessories
For use with Weight for fine-tuning or with Twister Concrete Remover where there is access at both ends. Use with Steering Axle.



Wire Hook for 1/2" Shaft

\$48.67

1350000125

Hub Accessories

The Wire Hook is attached at the end of the Shaft which will be then used for pulling and guiding. For 1/2" Shaft.



Wire Hook for 1/3" Shaft

\$44.03

1350000085

Hub Accessories

The Wire Hook is attached at the end of the Shaft which will be then used for pulling and guiding. For 1/3" Shaft.



Side Grinding Panel 1.5x2.33" No Wedge

\$34.68

1202040060

Side Grinding Panel

For Non-Wedge Hubs. Sold in packages of 12 panels.



Side Grinding Panel 2x4" No Wedge

\$35.16

1202050100

Side Grinding Panel

For Non-Wedge Hubs. Sold in packages of 12 panels.



Side Grinding Panel 2x4"

\$60.84

1203050100

Side Grinding Panel

Use with hubs: 2" Narrow 2W for 1/3" Shaft (1000820050), 3" Short for 1/3" Shaft (1000835050A) & 3" Short for 1/2" Shaft (1001235050A).

Sold in packages of 12 panels.



Side Grinding Panel 3x5"

\$61.20

1202075125

Side Grinding Panel

Use with hubs: 3" Narrow 2W for 1/3" Shaft (1000820075) & 3" (1001235075A).

Sold in packages of 12 panels.



Side Grinding Panel 4x4" for 6 Panel Hub

\$65.76

1202100100

Side Grinding Panel

4" & 6" pipes. Use with Hub 4-6" - 6 panel (1001250100A).

Sold in packages of 12 panels.



Side Grinding Panel 4x6" for 4 or 6 Panel Hub

\$74.50

1202100150

Side Grinding Panel

4" pipe: use with Hub 4" (1001240100A).

4" & 6" pipes: use with Hub 4-6" - 6 Panel (1001250100A).

Sold in packages of 12 panels.

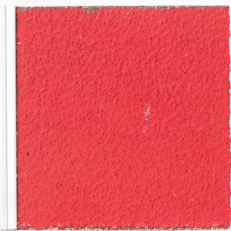

Side Grinding Panel 6x6" for 4 or 6 Panel Hub

\$79.20

1202150150

Side Grinding Panel

6" pipe: Hubs 6" (1001240150A) & 6" (1001870150A).

6" & 8" pipes: Hub 6-8" - 6 Panel (1001250150A).

Sold in packages of 12 panels.



Side Grinding Panel 6x8" for 4 or 6 Panel Hub

\$92.40

1202150200

Side Grinding Panel

6" pipe: use with Hub 6" (1001240150A). 6" & 8" pipes: use with Hub 6-8" 6 panel (1001250150A). 8-9" pipes: use with Hub 8-9" - 8 panel (1021800200).

Sold in packages of 12 panels.



Side Grinding Panel 6x10"

\$139.20

1202150250

Side Grinding Panel

6" pipe: use with Hub 6" (1001240150A). 6" & 8" pipes: use with Hub 6-8" 6 panel (1001250150A). 10-12" pipes: use with Hub 8-9" - 8 panel 18mm (1021800200).

Sold in packages of 12 panels.



Side Grinding Panel 8x12"

\$138.60

1202200300

Side Grinding Panel

8" pipe: use with Hub 8" (1001240200A).

Sold in packages of 12 panels.



Side Grinding Panel XT Rough 2x4" No Wedge

\$92.04

1204050100

Side Grinding Panel XT Rough

XT panels have larger grit for more aggression and faster results.

Sold in packages of 12 panels. For Non-Wedge Hubs.



Side Grinding Panel XT Rough 2x4"

\$98.28

1205050100

Side Grinding Panel XT Rough

XT panels have larger grit for more aggression and faster results.

Use with Hubs: 2" Narrow 2W for 2-3" Pipe - 1/3" Shaft (1000820050),

Hubs 3" Short for 3-4" Pipe - 1/3" Shaft & 1/2 Shaft (1000835050A) & (1001235050A).

Sold in packages of 12 panels.

Side Grinding Panel XT Rough 3x5" \$102.96

1203075125
 Side Grinding Panel XT Rough
 XT panels have larger grit for more aggression and faster results.
 Use with Hubs: 3" Narrow 2W - 1/3" Shaft (1000820075)
 & 3" Hub for 3-4" Pipe - 1/2 Shaft (1001235075A).
 Sold in packages of 12 panels.

Side Grinding Panel XT Rough 4x4" \$110.76

1203100100
 Side Grinding Panel XT Rough
 XT panels have larger grit for more aggression and faster results. 4" & 6" pipes.
 Use with Hub 4 & 6" (6-Panel) 1/2 Shaft (1001250100A).
 Sold in packages of 12 panels.

Side Grinding Panel XT Rough 4x6" \$117.00

1203100150
 Side Grinding Panel XT Rough
 XT panels have larger grit for more aggression and faster results.
 4" pipe: use with Hub 4" for 4" Pipe - 1/2 Shaft (1001240100A).
 4" & 6" pipes: use with Hub 4 & 6" (6-Panel) - 1/2 Shaft (1001250100A).
 Sold in packages of 12 panels.

Side Grinding Panel XT Rough 6x6" \$132.60

1203150150
 Side Grinding Panel XT Rough
 XT panels have larger grit for more aggression and faster results.
 6" pipe: Hub 6" for 6-8" Pipe - 1/2 Shaft (1001240150A) & 6" Hub (6-panel) (1001870150A).
 6" and 8" pipes: use with Hub 6 & 8" (6 Panel) - 1/2 Shaft (1001250150A).
 Sold in packages of 12 panels.

Side Grinding Panel XT Rough 6x8" \$154.44

1203150200
 Side Grinding Panel XT Rough
 XT panels have larger grit for more aggression and faster results.
 6" pipe: use with Hub 6" for 6-8" Pipe 1/2 Shaft (1001240150A).
 6" & 8" pipes: use with Hub 6 & 8" (6 Panel) - 1/2 Shaft (1001250150A).
 8-9" pipes, use with Hub 8-9" (8-panel) (1021800200). Sold in packages of 12 panels.

Side Grinding Panel XT Rough 6x10" \$224.64

1203150250
 Side Grinding Panel XT Rough
 XT panels have larger grit for more aggression and faster results.
 6" pipe: use with Hub 6" for 6-8" Pipe- 1/2 Shaft (1001240150A).
 6" & 8": use with Hub 6 & 8" (6 Panel) - 1/2 Shaft (1001250150A).
 10" & 12": use with Hub 8-9" (8-panel) (1021800200). Sold in packages of 12 panels.

Side Grinding Panel XT Rough 10x12" \$230.88

1203200300
 Side Grinding Panel XT Rough
 XT panels have larger grit for more aggression and faster results.
 8" pipe: use with Hub 8" for 8" Pipe -1/2 Shaft (1001240200A).
 Sold in packages of 12 panels.



Side Grinding Panel 1.25" Package (.98x1.57" No Wedge) \$23.40

1202025040
Side Grinding Panel
Panels for Mini Cleaner.
Sold in packages of 12 panels.



Side Grinding Panel 1.25" Package (1.18x1.97" No Wedge) \$27.00

1202030050
Side Grinding Panel
Panels for Mini Cleaner.
Sold in packages of 12 panels.



Cleaning Panel for 1.25" pipe (1.38x1.77" No Wedge) \$19.19

1241035045
Polishing Panel
Small no wedge Polishing Panels for cleaning with the Mini Cleaner.
Sold in packages of 12 panels.



Cleaning Panel for 1.5" pipe (1.57x1.97" No Wedge) \$23.87

1241040050
Polishing Panel
Small no wedge Polishing Panels for cleaning with the Mini Cleaner.
Sold in packages of 12 panels.

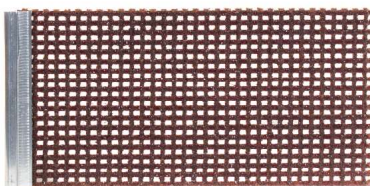

Polishing Panel 2x4" \$132.00

1241050100
Polishing Panel
Can be used to remove excess roughness in order to finalize CIPP lining.
Gentle cleaning in PVC pipe in fragile situations.
Sold in packages of 12 panels.

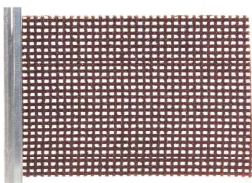

Polishing Panel 3x4" \$140.16

1241075100
Polishing Panel
Can be used to remove excess roughness in order to finalize CIPP lining.
Gentle cleaning in PVC pipe in fragile situations.
Sold in packages of 12 panels.

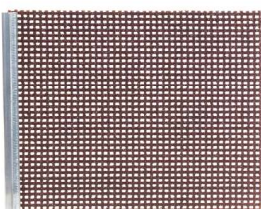

Polishing Panel 4x5" \$160.68

1241100125
Polishing Panel
Can be used to remove excess roughness in order to finalize CIPP lining.
Gentle cleaning in PVC pipe in fragile situations.
Sold in packages of 12 panels.

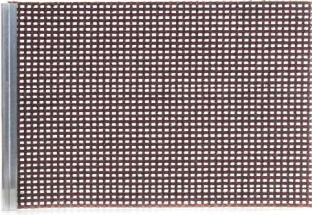

Polishing Panel 4x6"

\$181.08

1241100150

Polishing Panel

Can be used to remove excess roughness in order to finalize CIPP lining.

Gentle cleaning in PVC pipe in fragile situations.

Sold in packages of 12 panels.



Polishing Panel 6x8"

\$228.48

1241150200

Polishing Panel

Can be used to remove excess roughness in order to finalize CIPP lining.

Gentle cleaning in PVC pipe in fragile situations.

Sold in packages of 12 panels.

CUT BACK ON COSTLY MISTAKES

When lining towards a main or connection it is possible that the installation may inadvertently extend past the end of the pipe. This can create blockages and backups which can cause significant damage and expense. In these situations, Picote Pipe Cutters are fantastic tools to quickly and easily remove an overshoot lining that has extended into a connection. Simply attach the Pipe Cutter to your Miller, push it in place from the lateral and quickly cut off the excess lining.

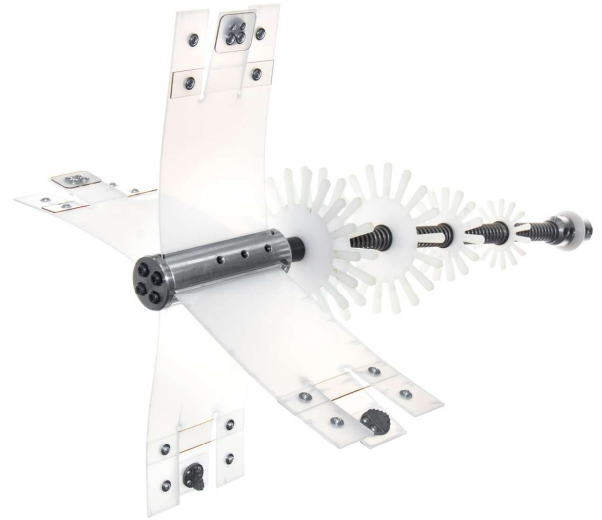

3" Pipe Cutter can be operated by the Mini, Super Midi, or Maxi Miller.

4" & 6" Pipe Cutters can be used with the Super Midi and Maxi Miller.

8" Pipe Cutter Ultra Flex can be combined with the Maxi Miller.

PIPE CUTTER

The **Standard Pipe Cutters** are sold as a panel pack that is combined with a Smart Cutter™ hub to create the final assembly.



The **Pipe Cutter Ultra Flex** is self-centering and designed for cutting off overshoot linings that occur directly after a bend.

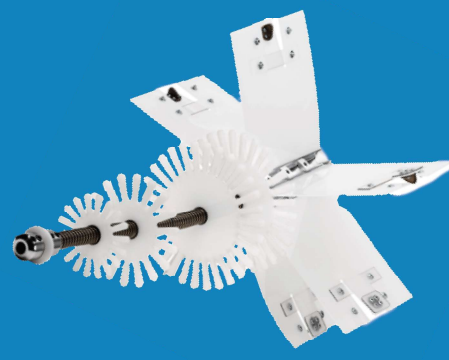

There are two Pipe Cutter models – the **Standard** and the **Ultra Flex**. The Standard and Ultra Flex models feature panels with hardened steel button teeth and both can navigate bends up to 90°.



Pipe Cutter Panel Package 3"

\$414.96

125000070

1/3" Shaft

Cut over-shot liners in a straight section of pipe

Includes 4 panels.

1/3" Shaft: Hub 2" Narrow 2W (1000820050) & Hub Disc 2W (1000200020)

1/2" Shaft: Hub 3" Short (1001235050A) & Hub Disc S (1000200035).



Pipe Cutter Panel Package 4"

\$483.84

1250000100

1/2" Shaft

Cut over-shot liners in a straight section of pipe

Includes 4 panels.

Used with Hub 3" 1/2" shaft (1001235075A) & Hub Disc S (1000200035).



Pipe Cutter Panel Package 6"

\$507.36

1250000150

1/2" Shaft

Cut over-shot liners in a straight section of pipe

Includes 4 panels.

Used with Hub 4" - 1/2" shaft (1001235075A) & Hub Disc L (1000200040).



Spare Part: Pipe Cutter Centralizer Package 4"

\$189.52

1250100100

Pipe Cutter Spare Part

Includes 2 Centralizers & Spacer Collet.



Spare Part: Pipe Cutter Centralizer Package 6"

\$189.52

1250150150

Pipe Cutter Spare Part

Includes 2 Centralizers & Spacer Collet.



Pipe Cutter Ultra Flex 4"

\$1,173.10

1250000101

1/2" Shaft

Used to cut over-shot liners when there a bend before the cutting location.

For spare panels use 4" panel (1250000100).



Pipe Cutter Ultra Flex 6"

\$1,205.00

1250000151

1/2" Shaft

Used to cut over-shot liners when there a bend before the cutting location.

For spare panels, use 6" panels (1250000150).



Pipe Cutter Ultra Flex 8"

\$1,302.16

1250000200

1/2" Shaft

Used to cut over-shot liners when there a bend before the cutting location.

For spare panels, use 8" panels (1250000201).

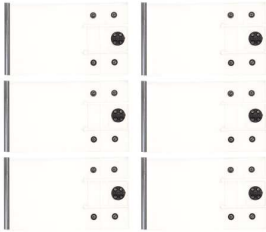

Pipe Cutter Spare Panels 8"

\$744.73

1250000201

Pipe Cutter Spare Part

Spare panels for Pipe Cutter Ultra Flex 8".

Includes 6 panels.



MAKE A GRAB FOR IT

The Grabber is a must-have on every job site. It allows you to quickly retrieve lost tools or foreign objects blocking a pipe, avoiding costly and time-consuming excavation.

The Original Grabber is designed for pipes of 4" diameter and above, and the Large Grabber can be used in 6" and larger pipes.

While viewing the location with your CCTV camera, simply push the grabber into position. The grabbing head is easily rotated so you can locate and grip the item with precision. Then, simply turn on the air valve to get a rock-solid grip on the object to pull it out and retrieve it. Turn off the air to release.

 Check out our video on Grabbers at:
[YouTube.com/PicoteSolutions](https://www.youtube.com/PicoteSolutions)

PICOTE GRABBERS

Original Grabber 4"+ | Large Grabber 6"+ | Small Grabber 2"- 3"

SMALL GRABBER

NEW Small Grabber for retrieving lost items in smaller diameter pipes. Available for 2"- 3" pipes in two lengths, 16ft and 32ft with the option of TWO styles of grabbing claw head!

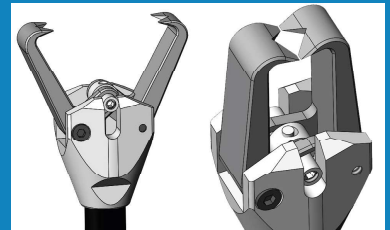

Jaw Type 1

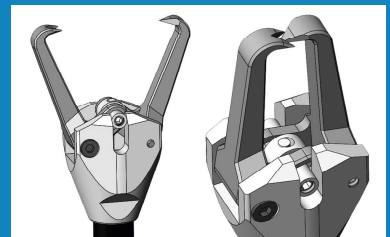

Jaw Type 2





Small Grabber 2-3" 16ft (1 Jaw Type)

\$975.00

2370000020

Grabber

Retrieve lost items or foreign objects. Range: 16ft (no extension available).

Includes two model 1 Jaws: 2" & 3".

Fits in 2" pipes or larger. No air pressure needed.



Small Grabber 2-3" 32ft (1 Jaw Type)

\$1,035.00

2370000021

Grabber

Retrieve lost items or foreign objects. Range: 32ft (no extension available).

Includes two model 1 Jaws: 2" & 3".

Fits in 2" pipes or larger. No air pressure needed.



Small Grabber Extra 2-3" 16ft with 2 Jaw types

\$1,147.50

2370000022

Grabber

Retrieve lost items or foreign objects. Range: 16ft (no extension available).

Includes two model 1 Jaws (2" & 3") and two model 2 Jaws (2" & 3").

Fits in 2" pipes or larger. No air pressure needed.



Small Grabber Extra 2-3" 32ft with 2 Jaw types

\$1,252.50

2370000023

Grabber

Retrieve lost items or foreign objects. Range: 32ft (no extension available).

Includes two model 1 Jaws (2" & 3") and two model 2 Jaws (2" & 3").

Fits in 2" pipes or larger. No air pressure needed.

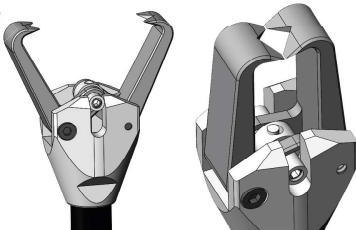

Small Grabber Jaw Set 1 for 2"

\$172.50

2370000024

Small Grabber Spare Part

Use Small Jaw Set 1 to pick up more rounded and smooth items which are harder to grip.

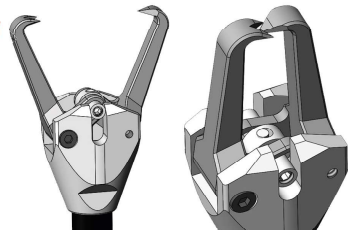

Small Grabber Jaw Set 2 for 2"

\$187.50

2370000025

Small Grabber Spare Part

Choose Small Jaw Set 2 to pick up chains and debris with good grabbing points.

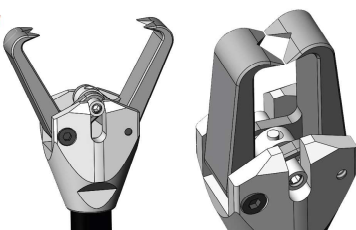

Small Grabber Jaw Set 1 for 3"

\$202.50

2370000026

Small Grabber Spare Part

Use Small Jaw Set 1 to pick up more rounded and smooth items which are harder to grip.

NEW

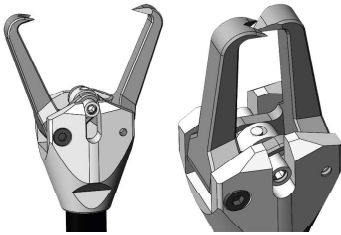

Small Grabber Jaw Set 2 for 3"

\$210.00

2370000027

Small Grabber Spare Part

Choose Small Jaw Set 2 to pick up chains and debris with good grabbing points.



Picote Grabber US

\$2,340.00

2370000001US

Grabber

Retrieve lost items or foreign objects.

Range: 32ft. Max Range: 96ft. Used with air compressor.

Comes with 2 different jaws. Jaws open to max. 3.2".

Fits in 4" pipes or larger. Max lifting weight 80lbs.



Picote Grabber Extension 32.8ft.

\$461.70

2370000002

Picote Grabber Extension

Increases the reach of the Picote Grabber by 32ft.

Includes connection piece.



Grabber Jaw Set 1

\$382.92

2370000003

Picote Grabber Spare Part

Choose Jaw Set 1 to pick up chains and debris with good grabbing points.



Grabber Jaw Set 2

\$382.92

2370000004

Picote Grabber Spare Part

Use Jaw Set 2 to pick up more rounded and smooth items which are harder to grip.



Picote Large Grabber US

\$2,898.00

2370000010US

Grabber

Retrieve lost or foreign objects.

Range: 32ft. Max Range: 96ft. Used with air compressor.

Comes with one set of jaws. Jaws open to max. 5.1".

Fits in 6" pipes or larger. Max lifting weight 150lbs.



Large Grabber Jaw Set 1

\$424.00

2370000011

Large Grabber Spare Part

Includes Jaws only.



Large Grabber Extension 32.8ft.

\$615.00

2370000012

Large Grabber Spare Part
Increases the reach of the Picote Large Grabber by 32ft.
Includes connection piece.



Spare Grabber Head with Jaws

\$1,072.50

2370000009

Picote Grabber Spare Part



Spare Large Grabber Head with Jaws

\$1,642.50

2370000013

Large Grabber Spare Part



Spare Grabber Steering Unit

\$322.50

2370000014

Picote & Large Grabber Spare Part

A HEAD THAT WEARS MANY HATS

The **Tiger Twister Front Drill Head** is an attachment to be used with the Tiger Twister Front Metal Panel as a center drill. The durable, multi-use Tiger FDH can also be used with Picote's Standard Twister, Twister Liner Remover and Twister.



The original **Front Metal Panel** is available in 3 models: 1mm for lateral cutters, 3mm for concrete removal and 3mm for liner removal.

FRONT PANELS & DRILL HEADS

The new **Tiger Front Metal Panel** has a precision manufactured milling plate equipped with specially hardened Tiger carbides.

The Tiger Front Metal Panel and Tiger Twister Front Drill Head can be also be added to the Smart Cutter™.





Front Drill Head 3"

\$319.00

1300214075

Twister Express
Spare Head for Twister Express 4" for Lined Pipe.



Front Drill Head 3.3"

\$350.00

1300214085

Twister Express
Spare Head for Twister Express 4" for Unlined Pipe.



Front Drill Head Kit for Twister Express 2"

\$358.00

1230000053

Twister Express & Twister Mini Flexi
Replacement Front Drill Head Kit, includes Front Drill Head and front brush.
Can also be used as a spare for Twister Mini Flex 2".



Front Drill Head Kit for Twister Express 3"

\$397.00

1230000073

Twister Express & Twister Mini Flexi
Replacement Front Drill Head Kit, includes Front Drill Head and front brush.
Can also be used as a spare for Twister Mini Flexi 3".



Front Drill Head for Twister Express 3" for Unlined Pipe

\$397.00

900000987

Twister Express
Replacement Front Drill Head Kit for 3" Twister Express for unlined pipe.
Includes Front Drill Head and front brushes.



Front Drill Head for Twister Express 3" for Lined Pipe

\$397.00

900000988

Twister Express
Replacement Front Drill Head Kit for 3" Twister Express for unlined pipe.
Includes Front Drill Head and front brushes.



Front Metal Panel 2.2"

\$39.05

1210310055

Twister & Smart Cutter™
Spare part. Thickness 1mm. Grit 10.
1mm Front Metal Panel. Flexibility combined with carbides at the rear of the panel provide an advantage in reinstatement situations where the panel gets stuck.



Front Metal Panel 3"

\$47.43

1210310075

Twister & Smart Cutter™

Spare part. Thickness 1mm. Grit 10.

1mm Front Metal Panel. Flexibility combined with carbides at the rear of the panel provide an advantage in reinstatement situations where the panel gets stuck.



Front Metal Panel 3.3"

\$49.24

1210310085

Twister & Smart Cutter™

Spare part. Thickness 1mm. Grit 10.

1mm Front Metal Panel. Flexibility combined with carbides at the rear of the panel provide an advantage in reinstatement situations where the panel gets stuck.

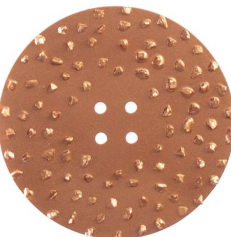

Front Metal Panel 4.5"

\$56.31

1210310115

Twister & Smart Cutter™

Spare part. Thickness 1mm. Grit 10.

1mm Front Metal Panel. Flexibility combined with carbides at the rear of the panel provide an advantage in reinstatement situations where the panel gets stuck.



Front Metal Panel 5"

\$60.55

1210310125

Twister & Smart Cutter™

Spare part. Thickness 1mm. Grit 10.

1mm Front Metal Panel. Flexibility combined with carbides at the rear of the panel provide an advantage in reinstatement situations where the panel gets stuck.

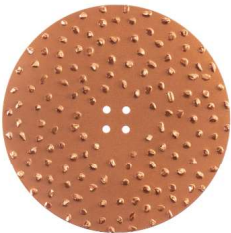

Front Metal Panel 7"

\$70.28

1210310175

Twister & Smart Cutter™

Spare part. Thickness 1mm. Grit 10.

1mm Front Metal Panel. Flexibility combined with carbides at the rear of the panel provide an advantage in reinstatement situations where the panel gets stuck.



Front Metal Panel 3" for Liner Remover

\$83.60

1210410075

Twister Liner Remover

Spare part. Panel thickness: 3mm. Grit 10

3mm Front Metal Panel for Twister Liner Remover with additional carbides on the back.



Front Metal Panel 3.3" for Liner Remover

\$90.34

1210410085

Twister Liner Remover

Spare part. Panel thickness: 3mm. Grit 10

3mm Front Metal Panel for Twister Liner Remover with additional carbides on the back.



Front Metal Panel 4.5" for Liner Remover

\$104.81

1210410115

Twister Liner Remover

Spare part. Panel thickness: 3mm. Grit 10

3mm Front Metal Panel for Twister Liner Remover with additional carbides on the back.



Front Metal Panel 5" for Liner Remover

\$108.92

1210410125

Twister Liner Remover

Spare part. Panel thickness: 3mm. Grit 10

3mm Front Metal Panel for Twister Liner Remover with additional carbides on the back.



Front Metal Panel 7" for Liner Remover

\$145.00

1210410175

Twister Liner Remover

Spare part. Panel thickness: 3mm. Grit 10

3mm Front Metal Panel for Twister Liner Remover with additional carbides on the back.

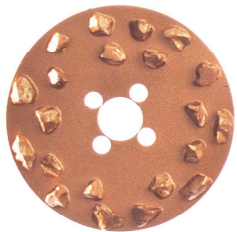

Front Metal Panel 3" for Concrete Remover

\$188.00

1210510075

Twister Concrete Remover

Spare part. Panel thickness: 3mm. Grit 6.

3mm Front Metal Panel for Twister Concrete Remover with larger carbides.



Front Metal Panel 3.3" for Concrete Remover

\$190.00

1210510085

Twister Concrete Remover

Spare part. Panel thickness: 3mm. Grit 6.

3mm Front Metal Panel for Twister Concrete Remover with larger carbides.



Front Metal Panel 3.75" for Concrete Remover

\$197.00

1210510095

Twister Concrete Remover

Spare part. Panel thickness: 3mm. Grit 6.

3mm Front Metal Panel for Twister Concrete Remover with larger carbides.



Front Metal Panel 4.5" for Concrete Remover

\$217.00

1210510115

Twister Concrete Remover

Spare part. Panel thickness: 3mm. Grit 6.

3mm Front Metal Panel for Twister Concrete Remover with larger carbides.



Front Metal Panel 5" for Concrete Remover

\$235.00

1210510125

Twister Concrete Remover
Spare part. Panel thickness: 3mm. Grit 6.
3mm Front Metal Panel for Twister Concrete Remover with larger carbides.



Front Metal Panel 5.1" for Concrete Remover+

\$247.50

1210510130

Twister Concrete Remover+
Spare part. Panel thickness: 3mm. Grit 6. For Maxi Power+.
3mm Front Metal Panel for Twister Concrete Remover with larger carbides.



Front Metal Panel 7" for Concrete Remover+

\$283.50

1210510175

Twister Concrete Remover+
Spare part. Panel thickness: 3mm. Grit 6. For Maxi Power+.
3mm Front Metal Panel for Twister Concrete Remover with larger carbides.



Front Metal Panel 8" for Concrete Remover+

\$322.50

1210510200

Twister Concrete Remover+
Spare part. Panel thickness: 3mm. Grit 6. For Maxi Power+.
3mm Front Metal Panel for Twister Concrete Remover with larger carbides.



Tiger Front Metal Panel 2.3" for 3" Pipe

\$228.00

1260000058

Smart Cutter™
Spare part. Panel thickness: 6mm.
Precision manufactured milling plate equipped with the specially hardened Tiger carbides. High quality sand-blasted aluminum.



Tiger Front Metal Panel 3" for 4" Pipe

\$247.50

1260000075

Twister & Smart Cutter™
Spare part. Panel thickness: 6mm.
Precision manufactured milling plate equipped with the specially hardened Tiger carbides. High quality sand-blasted aluminum.



Tiger Front Metal Panel 3.3" for 4" Pipe

\$267.00

1260000085

Twister & Smart Cutter™
Spare part. Panel thickness: 6mm.
Precision manufactured milling plate equipped with the specially hardened Tiger carbides. High quality sand-blasted aluminum.



Tiger Front Metal Panel 3.5" for 5" Pipe

\$271.50

126000090

Twister & Smart Cutter™

Spare part. Panel thickness: 6mm.

Precision manufactured milling plate equipped with the specially hardened Tiger carbides. High quality sand-blasted aluminum.



Tiger Front Metal Panel 4" for 5" Pipe

\$282.00

126000100

Twister & Smart Cutter™

Spare part. Panel thickness: 6mm.

Precision manufactured milling plate equipped with the specially hardened Tiger carbides. High quality sand-blasted aluminum.



Tiger Front Metal Panel 4.5" for 6" Pipe

\$313.50

126000115

Twister & Smart Cutter™

Spare part. Panel thickness: 6mm.

Precision manufactured milling plate equipped with the specially hardened Tiger carbides. High quality sand-blasted aluminum.



Tiger Front Metal Panel 4.9" for 6" Pipe

\$327.00

126000125

Twister & Smart Cutter™

Spare part. Panel thickness: 6mm.

Precision manufactured milling plate equipped with the specially hardened Tiger carbides. High quality sand-blasted aluminum.



Tiger Front Metal Panel 6.9" for 8" Pipe

\$424.50

126000175

Twister & Smart Cutter™

Spare part. Panel thickness: 6mm.

Precision manufactured milling plate equipped with the specially hardened Tiger carbides. High quality sand-blasted aluminum.



Tiger Front Metal Panel 2.6"

\$235.50

126000065

Smart Cutter™

Spare part. Panel thickness: 6mm.

Precision manufactured milling plate equipped with the specially hardened Tiger carbides. High quality sand-blasted aluminum.



Tiger Front Metal Panel 3.1"

\$258.00

126000080

Smart Cutter™

Spare part. Panel thickness: 6mm.

Precision manufactured milling plate equipped with the specially hardened Tiger carbides. High quality sand-blasted aluminum.



Tiger Front Metal Panel 5.5"

\$373.50

1260000140

Smart Cutter™

Spare part. Panel thickness: 6mm.

Precision manufactured milling plate equipped with the specially hardened Tiger carbides. High quality sand-blasted aluminum.

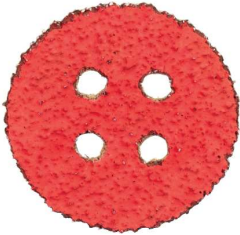

Front Plastic Panel 2.2"

\$6.75

1220210055

Smart Cutter™

Gentle option for PVC or special situations in fragile pipes.

Sold in packages of 10 panels.

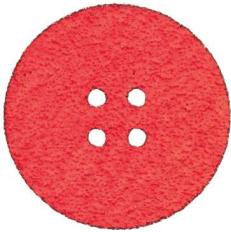

Front Plastic Panel 3"

\$7.63

1220210075

Smart Cutter™

Gentle option for PVC or special situations in fragile pipes.

Sold in packages of 10 panels.

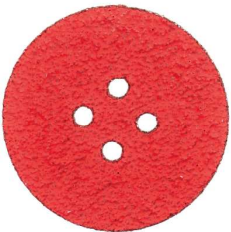

Front Plastic Panel 3.3"

\$7.63

1220210085

Smart Cutter™

Gentle option for PVC or special situations in fragile pipes.

Sold in packages of 10 panels.

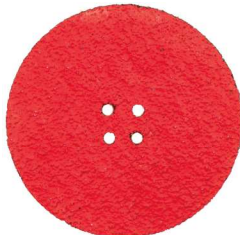

Front Plastic Panel 5"

\$8.33

1220210125

Smart Cutter™

Gentle option for PVC or special situations in fragile pipes.

Sold in packages of 10 panels.

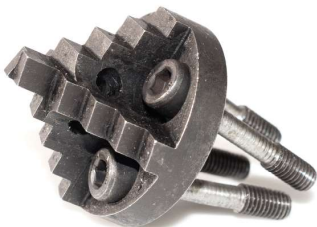

Front Drill Head 3 Ridged Hardened 1.38"

\$138.85

1300212035

Twister & Smart Cutter™

Use with Twister with Front Metal Panels.

Also use with Smart Cutter™ with Front Metal or Front Plastic Panels.



Front Drill Head Twister Concrete Remover

\$267.40

1300215040

Twister Concrete Remover

Use with Twister Concrete Remover with Front Metal Panels.



Tiger Front Drill Head 1.5"

\$187.50

1260010038
Twister & Smart Cutter™
Use with any Twister or Smart Cutter™.



Front Drill Head 4 Flat Twister Liner Remover 1.57"

\$195.23

1300214040
Twister Liner Remover
Use with Twister Liner Remover with Front Metal Panels.



Steering Axle 2.16"

\$57.41

1100100055
Concrete Remover Spare Part
For fine-tuning or steering tools.



Bearing for Steering Axle

\$10.57

1100200001
Concrete Remover Spare Part
Use with Steering Axle.



LEAD THE WAY

Leaders are pre-built, allowing the operator to quickly switch between different tooling in the field. Using Leaders saves time and extends the life of the flexible shaft.



Leaders are attached to the shaft via a shaft connector, ensuring the optimal amount of shaft is exposed outside of the outer casing. Many Picote tools can be built with Leaders, which is especially beneficial for Original Chains, Cyclone Chains and Smart Cutter™ Hubs.

 **Check out our video on Leaders at: [YouTube.com/PicoteSolutions](https://www.youtube.com/PicoteSolutions)**

SHAFTS, SLEEVES & SHAFT CONNECTORS

SHAFT LUBRICANT

Prolong the lifespan of your Miller with Picote Flexible Shaft Lubricant. Instructions on maintaining the shaft, including how to lubricate are included in your Miller operating manuals. Further information and guides can be found on the Picote Institute: www.picoteinstitute.com





Flexible Shaft 1/4"

1312020065025	25ft	\$ 206.11
1312020065050	50ft	\$ 412.21



Flexible Shaft 1/3" (Thick Casing)

1312030085010	32ft	\$ 265.78
1312030085025	25ft	\$ 202.52
1312030085050	50ft	\$ 405.04
1312030085075	75ft	\$ 607.56
1312030085100	100ft	\$ 810.09



Flexible Shaft 3/8"

1312020105005	16.4ft	\$ 118.65
1312020105010	32ft	\$ 237.30
1312020105015	49ft	\$ 355.95
1312020105020	65.5ft	\$ 474.60



Flexible Shaft 1/2"

1312020125010	32ft	\$ 351.96
1312020125025	25ft	\$ 268.19
1312020125050	50ft	\$ 536.39
1312020125075	75ft	\$ 804.58
1312020125100	100ft	\$ 1,072.77



Flexible Shaft 1/2" (Thick Casing)

1312021125050	50ft	\$ 601.44
1312021125075	75ft	\$ 902.13
1312021125100	100ft	\$ 1,202.84



Flexible Shaft 3/4"

1312021180011	36 ft	\$ 640.00
1312021180020	67 ft	\$1,192.50



Shaft Casing

9331008000	Thick Outer Casing for 1/3" shaft	10.88 \$ per 3.28ft
9330012000	Regular Outer Casing for 1/2" shaft	13.13 \$ per 3.28ft
9331012000	Thick Outer Casing for 1/2" shaft	14.25 \$ per 3.28ft
3212323196	Outer Casing for 3/4" shaft	42.38 \$ per 3.28ft



Miller Replacement Shaft (1/3" & 3/8" Shaft)

1312030085014	Micro Miller (43.6ft)	\$ 328.24
1312030085017	Mini Miller (54.7ft)	\$ 478.40
131203108517	Mini Cleaner (54.1ft)	\$ 337.50
1312020105025	Super Midi 3/8" Shaft (82ft)	\$ 593.25



Miller Replacement Shaft (1/2" & 3/4" Shaft)

1312020125013	Midi Miller (44ft)	\$ 475.15
1312020125022	Super Midi (70ft)	\$ 691.37
1312021125033	Maxi Miller (108ft)	\$ 1,302.29
1312021180020	Maxi Power+ (67ft)	\$ 1,192.50



Shaft Socket for Drill

1310000065	For 1/4" shaft	\$ 71.10
1310000085	For 1/3" shaft	\$ 48.72
1310000105	For 3/8" shaft	\$ 48.00
1310000125	For 1/2" shaft	\$ 51.82



Shaft Connector

9123050001	1/3" / 1/3"	\$ 58.11	900000336	1/3" / 3/8"	\$ 62.01
1313002105	3/8" / 3/8"	\$ 72.00	1313001285	1/2" / 1/3"	\$ 66.60
1313002125	1/2" / 1/2"	\$ 61.54	900000234	1/2" / 3/8"	\$ 76.36
1313002185	3/4" / 3/4"	\$ 121.68			



Sleeves

93212321085	For 1/3" (thick casing)	\$ 19.85
93212322105	For 3/8"	\$ 26.18
93212321125	For 1/2"	\$ 24.50
93212322125	For 1/2" (thick casing)	\$ 24.50



Leaders

1400800500	1/3" Leader 19.7"	\$ 84.48
1401000500	3/8" Leader 19.7"	\$ 88.50
1401200500	1/2" Leader 19.7"	\$ 94.00
1401800500	3/4" Leader 19.7"	\$ 262.00



Shaft Lubricant Oil

1350000020	Shaft Lubricant (17 oz)	\$ 19.89
1350000021	Shaft Lubricant Package, includes 6 bottles	\$ 97.89

**BE PREPARED!
HAVE SPARE PARTS
READY TO GO**



MILLER SPARE PARTS

Mini Cleaner | Mini Cleaner +C | Battery Mini Cleaner | Battery Mini Cleaner +C |
Mini Miller | Mini Miller +C | Battery Mini Miller | Battery Mini Miller +C | Super Midi
Miller | Maxi Miller | Maxi Plus Miller | Maxi Miller Power+



SAFETY CLUTCH

The Safety Clutch for the Mini Miller and Mini Miller +C has a White Silicone Spring and the safety clutch for the Mini Cleaner and Mini Cleaner +C has a Red Silicone Spring. These parts can be easily replaced by following installation instructions included in the relevant operating manual which can be found in the Resources section of the Picote Institute: www.picoteinstitute.com



Micro/Mini Miller Handle Upgrade Kit

\$241.80

9530000045

Mini Miller & Mini Cleaner Handle

Add the foldable handle to your older style Mini Miller or Mini Cleaner with the Handle Upgrade Kit to make transporting your Miller easier.



Mini Cleaner +C Upgrade Kit

\$2,426.00

3540001000US

Mini Miller & Mini Cleaner

Upgrade Mini Miller or Mini Cleaner with a camera that makes viewing of cleaning and cutting easier. Camera cable: 98' Screen size: 7" Color Monitor.

Camera Head: 9/16" Lighting: 8 LEDs with brightness control
Digital footage counter, stainless steel camera head (IP68).



Mini Miller +C Upgrade Kit

\$2,874.00

3540002000US

Mini Miller & Mini Cleaner

Upgrade Mini Miller or Mini Cleaner with a camera that makes viewing of cleaning and cutting easier. Camera cable: 98' Screen size: 7" Color Monitor.

Camera Head: 7/8" (self levelling) Lighting: 12 LEDs with brightness control
Digital footage counter, stainless steel camera head (IP68).



Strain Relief Mini Miller 1/3" Thick Casing

\$76.05

9530000134

Mini Miller

For older style Mini Miller without Safety Clutch.



Strain Relief Spring Mini for Safety Clutch

\$72.15

9530000134-1

Mini Miller

For Mini Miller & Mini Cleaner with Safety Clutch.



Strain Relief Super Midi with 3/8" Shaft

\$72.75

9550000070

Super Midi 10mm



Strain Relief Midi Miller/Super Midi

\$76.05

9550000034

Super Midi 12mm & Midi Miller



Strain Relief Maxi Miller

\$95.18

9560000034
Maxi Miller



Safety Clutch Upgrade Kit for Mini Miller

\$472.00

9530000041
Mini Miller
Upgrade older style Mini Millers to include the latest Safety Clutch.



Mini Miller Safety Clutch

\$367.00

900000856
Mini Miller



Mini Cleaner Safety Clutch

\$400.00

900001204
Mini Cleaner



Spare Axle Package for Safety Clutches

\$65.70

9530000047
Mini Miller & Mini Cleaner
Includes 6pcs.



Silicone Spring for Mini Miller (White)

\$78.00

900000920
Mini Miller
Replacement Silicone Spring (white) for Mini Miller (5 pieces).



Silicone Spring for Mini Cleaner (Red)

\$82.50

900001205
Mini Cleaner
Replacement Silicone Spring (red) for Mini Cleaner (5 pieces).



Standard Battery for Mini Cleaner & Mini Miller

\$1,656.00

9540004013

Battery Mini Miller & Mini Cleaner
Comes with Battery Mini Cleaner & Battery Mini Miller.
Standard Battery provides up to 3 hours of continuous work.
Weight: 8lbs



High Output Battery for Mini Cleaner & Mini Miller

\$1,998.00

9540004035

Battery Mini Miller & Mini Cleaner
Comes with Battery Mini Cleaner & Battery Mini Miller.
High Output Battery provides up to 4 hours of continuous work.
Weight: 9 lbs



Spare Charger for Mini Cleaner & Mini Miller Batteries

\$292.50

9540004013US

Battery Mini Miller & Mini Cleaner
Suitable for charging Standard and High Output Batteries.



Mini Reel Brake Upgrade Package

\$195.00

9540000075

Mini Miller & Mini Cleaner
For all Mini Miller and Mini Cleaner models.
With Mini Reel Brake, easily lock your Miller's reel securely in position providing Miller users additional convenience and security during transportation.

MINI CLEANER TOOLS



Check out our video of the Smart Sweeper at:
[YouTube.com/PicoteSolutions](https://www.youtube.com/PicoteSolutions)



Smart Cutter™

For descaling and general cleaning. Also for smoothing down connections after reinstatements.



Cleaning Chain or Brush

For descaling and general cleaning. Cleaning Brushes are suitable for very fragile pipes.



Special Drill Head

For cleaning and reinstatements.

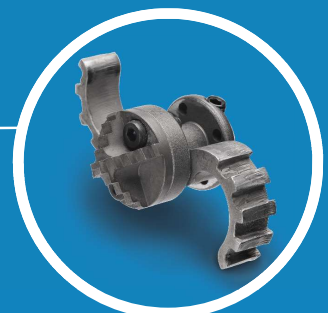

Mini Smart Sweeper

For removing hard scale or breaking up FOGs from inside the pipe.



Twister Mini Flexi

Open lateral connections fast, even through P-traps. Available for 2" or 3" pipes.



Mini Cleaner US

\$3,997.00

3540000816US (Cleaning Package) 3540000818US (Cutting Package)

Cleaning & Cutting (1/3" Shaft)

High Speed Cleaning 1 1/4"-3", Cutting 1 1/4"-3" & Brush Coating 1 1/4"-3".

Max Range: 50ft (no extension recommended). Weight: 59lbs. 500-2900rpm.



Cleaning Tools Package

\$311.00

3540000818CL

Cleaning (1/3" Shaft)

Includes 1x Smart Cleaner Hub for 1 1/4 - 1.5" (1000818025), 1x Side Grinding Panel 1 1/4" Package (1201030045), 1x Side Grinding Panel 1.5" Package (1201030050), 1x Cleaning Chain 1 1/4" (1381084032), 1x Cleaning Chain 1.5" (1381084040) & 1x Front Drill Head 1" for 2" pipes (1300212025).



Cutting Tools Package

\$813.00

3540000818CU

Cutting (1/3" Shaft)

Includes 1x Smart Sweeper Head 1.57"-2" (1360080051), 1x Smart Cleaner Hub 1.25"-1.57" (1000818025), 1x Side Grinding Panel 1.57" Package (1201030050) & Twister Mini Flexi 2" (1230000054).



Smart Cleaner Hub 1 1/4"-1.57" - 1/3" Shaft

\$42.98

1000818025

Cleaning & Cutting (1/3" Shaft)

Use with Side Grinding, Polishing and Cleaning Panels with no wedge.



Cleaning Panel 1 1/4" Package (1.37x1.77" No Wedge)

\$19.19

1241035045

Cleaning (1/3" Shaft)

Panels for Mini Cleaner. More gentle option for cleaning plastic pipes.

Sold in packages of 12 panels.



Cleaning Panel 1 1/2" Package (1.57x2" No Wedge)

\$23.87

1241040050

Cleaning (1/3" Shaft)

Panels for Mini Cleaner. More gentle option for cleaning plastic pipes.

Sold in packages of 12 panels.



Cleaning Chain 1 1/4" - 1/3" Shaft

\$14.70

1381084032

Cleaning (1/3" Shaft)

No carbides. For Mini Cleaner.



Cleaning Chain 1.5" - 1/3" Shaft

\$14.85

1381084040
Cleaning (1/3" Shaft)
No carbides. For Mini Cleaner.



Cleaning Brush 1 1/4" - 1/3" Shaft

\$19.80

2125000032CL
Cleaning (1/3" Shaft)
Custom designed, high-quality and long lasting brush with nylon bristles for brush coating and cleaning PVC pipes.



Cleaning Brush 1 1/2" - 1/3" Shaft

\$19.80

2125000040CL
Cleaning (1/3" Shaft)
Custom designed, high-quality and long lasting brush with nylon bristles for brush coating and cleaning PVC pipes.



Mini Cleaner Replacement Shaft & Casing 54ft

\$337.50

131203108517
Mini Cleaner Spare Part
Replacement shaft and flexible spring outer casing for Mini Cleaner.



Mini Cleaner Shaft Spring Casing 54ft

\$247.50

9311713099
Mini Cleaner Spare Part
Replacement spring outer spring casing for Mini Cleaner.



Silicone Spring Package for Mini Cleaner

\$82.50

900001205
Mini Cleaner Spare Part
Replacement silicone spring (Red) for Mini Cleaner (5 pieces).



Cyclone PVC Chain 3" - 1/3" Shaft

\$46.80

1381084070P
Cleaning (1/3" Shaft)
No carbides. Self-centering, general cleaning chain for descaling and removing light roots in fragile pipes such as plastic, copper and clay.



Cyclone PVC Chain 4" - 1/3" Shaft

\$62.40

1381084100P

Cleaning (1/3" Shaft)

No carbides. Self-centering, general cleaning chain for descaling and removing light roots in fragile pipes such as plastic, copper and clay.



Original PVC Chain 2" - 1/3" Shaft

\$37.44

1380084050P

Cleaning (1/3" Shaft)

No carbides. Self-centering, general cleaning chain for descaling and removing light roots in fragile pipes such as plastic, copper and clay.



Tiger Original Chain 2" - 1/3" Shaft

\$100.50

1380084050V

Cleaning (1/3" Shaft)

Developed for aggressive cleaning and liner removal jobs. Equipped with extra-hard carbide teeth, they shred through tough obstacles.



Tiger Drill Chain 3" - 1/3" Shaft

\$142.50

1380084070VP

Cleaning (1/3" Shaft)

Original Tiger Chain with an integrated front drill head featuring the long lasting carbides to help cut through roots and lightly collapsed liners.



Tiger Cyclone Chain 3" - 1/3" Shaft

\$139.50

1381084075V

Cleaning (1/3" Shaft)

A gentle, lightweight option for cleaning cast iron pipes, with extra-hard, long lasting carbide teeth. Centrifugal force centers the tool inside the pipe, providing greater protection for damaged or fragile pipes.

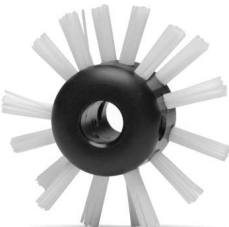

Coating/Cleaning Brush 2" - 1/3" Shaft

\$23.93

2120000075

Cleaning (1/3" Shaft)

Custom designed, high-quality and long lasting brush with nylon bristles for brush coating and cleaning PVC pipes.



Coating/Cleaning Brush 3" - 1/3" Shaft

\$24.68

2120000100

Cleaning (1/3" Shaft)

Custom designed, high-quality and long lasting brush with nylon bristles for brush coating and cleaning PVC pipes.



Coating/Cleaning Brush 4" - 1/3" Shaft

\$26.63

2120000125

Cleaning (1/3" Shaft)

Custom designed, high-quality and long lasting brush with nylon bristles for brush coating and cleaning PVC pipes.



Side Grinding Panel 1 1/4" (1x1.57" No Wedge)

\$23.40

1202025040

Cleaning & Cutting (1/3" Shaft)

Sold in packages of 12 panels.



Side Grinding Panel 1 1/2" (1.18x2" No Wedge)

\$27.00

1202030050

Cleaning & Cutting (1/3" Shaft)

Sold in packages of 12 panels.



Mini Smart Sweeper 1 1/2 - 2" - 1/3" Shaft

\$307.00

1360080050

Cleaning (1/3" Shaft)

Game changer for 1 1/2-2" pipes. Versatile tool for tough cleaning scenarios including tuberculation, roots, calcite, & mineral/uranic scale in cast iron, concrete, clay, & PVC pipes. Includes 1x Front Drill Head 1" & Hub Disc 2".



Mini Smart Sweeper 3" - 1/3" Shaft

\$397.00

1360080075

Cleaning (1/3" Shaft)

Versatile tool for tough cleaning scenarios including tuberculation, roots, calcite, & mineral/uranic scale in cast iron, concrete, clay, & PVC pipes. Includes 1x Front Drill Head 1.57" & Hub Disc 3".



Front Drill Head 1" for Smart Sweeper 2"

\$99.84

1300212025

Cleaning (1/3" Shaft)

For 2" Smart Sweeper



Front Drill Head 4 Flat 1.57"-2" for Smart Sweeper 3"

\$148.60

1300214042

Cleaning (1/3" Shaft)

For 3" Smart Sweeper (Flat 1.4"- 1.6" No Thread).

Can also be used with a 4" Smart Sweeper and 4" and 6" Smart Spiders.

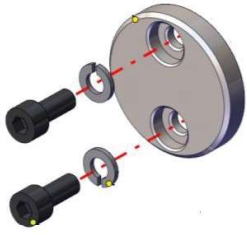

Hub Disc 0x25x4 for Smart Sweeper 2"

\$19.11

1000200025
Sweeper Spare Part
Hub Disc (0x25x4) with Screws.

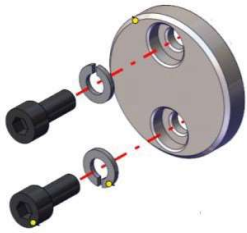

Hub Disc for Smart Sweeper 3"

\$22.23

1360080002
Sweeper Spare Part
Hub Disc for 3" Smart Sweeper.



Mini Sweeper Leg 2"

\$48.35

900000935
Cleaning (1/3" Shaft)
Price per Leg. (2 needed).



Mini Sweeper Leg 3"

\$67.88

900000942
Sweeper Spare Part
Price per Leg. (2 needed).



Twister Mini Flexi 2" - 1/3" Shaft

\$682.50

1230000054
Cutting (1/3" Shaft)
For reinstatements through problematic bends, multiple bends or P-traps.
Spare Drill Head: 1230000053.



Twister Mini Flexi 3" - 1/3" Shaft

\$766.50

1230000074
Cutting (1/3" Shaft)
For reinstatements through problematic bends, multiple bends or P-traps.
Spare Drill Head: 1230000073.



Special Drill Head Cutter 1"

\$209.40

1310820029
Cleaning & Cutting (1/3" Shaft)
For use in cast iron pipes for initial liner opening and blockages. Square design/side blades allows the cutter to tumble on obstacles/connections to make hole larger than the physical size of drill head.

A POWERFUL COMBINATION FOR THE TOUGHEST JOBS

With 3-phase 400v power behind it the Maxi Power+ is a beast of a machine that gets the job done with a range of specially designed tools for:

- **Heavy Descaling**
- **Root Cutting**
- **Reinstatements**
- **Unblocking**
- **Removing:**
 - Intruding Connections & Displaced Joints
 - Concrete & Failed CIPP Linings
 - Metal Rebar
 - Pipe Bungs & Foreign Objects
- **Specialized Cleaning**
 - Silicate Deposits, Welds, Wax, Coatings

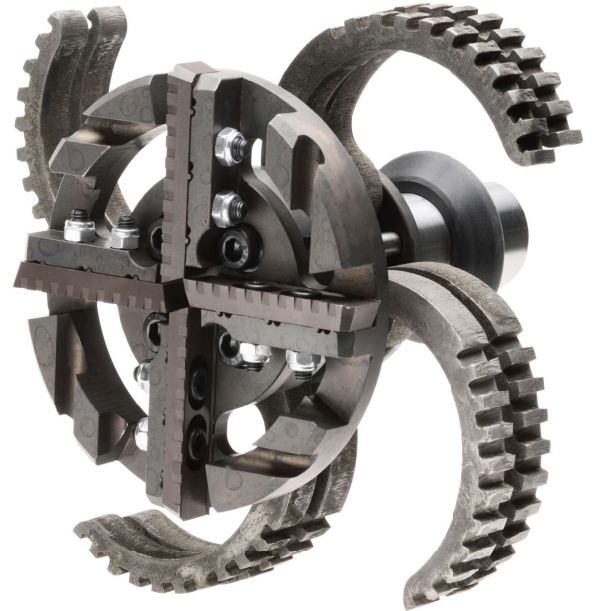

MAXI POWER+ TOOLS

AGGRESSIVE LINER & CONCRETE REMOVAL

The Maxi Power+ has a range of innovative tools to power through concrete or failed CIPP Linings. From 4" in straight pipes and 6" to 12" for pipes with multiple bends.

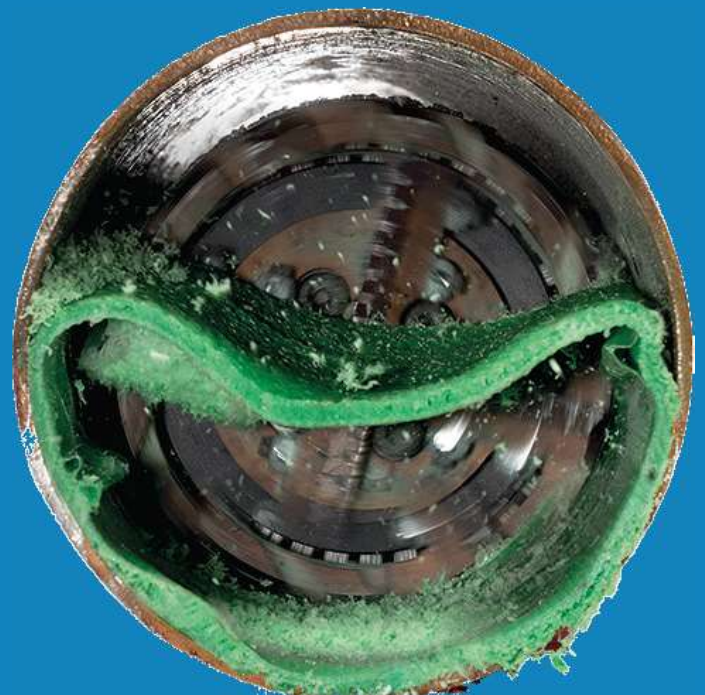



Maxi Miller Power+ US

\$17,940.00

3570032018US

3/4" Shaft

High speed cleaning 4-12" & cutting 3-12" (3" & 4" only for straight pipes). 400v/3-phase/30amp. Range 60ft. Add 2x36ft extensions: max range 132ft. Extension sold separately (1312021180011 Shaft 3/4" 36ft). 500-1500rpm. Weight 249lbs.

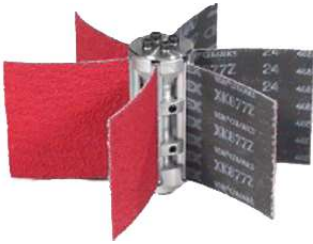

Smart Cutter™ Hub 4 & 6" (6-Panel) - 1/2 Shaft

\$384.72

1001250100A

Smart Cutter™

6-Panel Hub, aluminum. Hub Disc XL included (1000200050)

When used with Maxi Power+ Specialized Shaft Connector 3/4"-1/2" (1313001812) is needed. 12(S)x50(D)x100(L).



Specialized Shaft Connector 3/4"/1/2"

\$142.74

1313001812

Smart Cutter™

For connecting to 3/4" to 1/2" Shaft.

Use inside 6-Panel Hub (above) to connect the Hub to Maxi Power+.

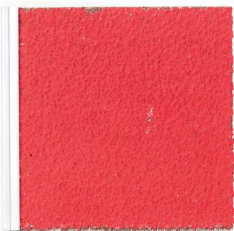

Side Grinding Panel 4"x4" for 6 Panel Hub

\$65.76

1202100100

Smart Cutter™

Sold in packages of 12 panels.



Smart Cutter™ Hub Disc 2" XL (6-panel)

\$31.84

1000200050

Smart Cutter™

For Hub 12.5x50x100 (1001250100A).

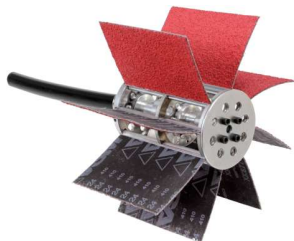

Smart Cutter™ Hub 6" (6-panel)

\$560.43

1001870150A

Smart Cutter™

A cleaning & fine-tuning tool. For reinstatements make the first initial cut with a Twister+ and follow up by grinding remaining edges with the Smart Cutter+. Also, removes inconsistencies, wrinkles and remains of failed liner. Use in cast iron, concrete, clay and PVC pipes.



Side Grinding Panel 6x6"

\$79.20

1202150150

Smart Cutter™

Sold in packages of 12 panels.



Smart Cutter™ Hub Disc 2.75" XXL (6 Panel)

\$52.26

1000200070

Smart Cutter™

For Hub 18.5x70x150 (1001870150A). Hub Disc diameter 2.75" (1000200070).

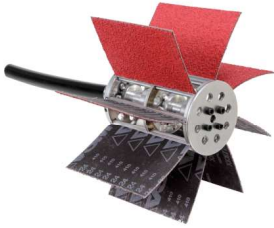

Smart Cutter™ Hub 8-9" (8-panel)

\$663.00

1021800200

Smart Cutter™

A cleaning & fine-tuning tool. For reinstatements make the first initial cut with a Twister+ and follow up by grinding remaining edges with the Smart Cutter+. Also, removes inconsistencies, wrinkles and remains of failed liner. Use in cast iron, concrete, clay and PVC pipes.



Side Grinding Panel 6x8" for 8-9" Pipe

\$92.40

1202150200

Smart Cutter™

Sold in packages of 12 panels.

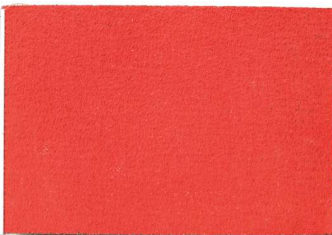

Side Grinding Panel 6x10" for 10-12" Pipe

\$139.20

1202150250

Smart Cutter™

Sold in packages of 12 panels.



Hub Disk 4" XXXL (8-Panel)

\$58.11

1000200100

Smart Cutter™

For Hub 18.5x100x150 (1021800200). Hub Disc diameter 4" (1000200100).



Smart Crusher 3" - 3/4" Shaft

\$1,012.00

1370180070

Liner Remover

Diameter of the Drill Head: 2.36". Only for straight pipes.

For cast iron pipes only.



Smart Crusher 4" - 3/4" Shaft

\$2,197.00

1370180100

Liner Remover

For situations where the collapse is in the center or fully collapsed. Makes the initial removal, follow up with Cyclone Premium or Smart Cutter™.

Front Drill Head can be used for liner that has sagged from the top (sold separately 1300215085). For cast iron pipes only.

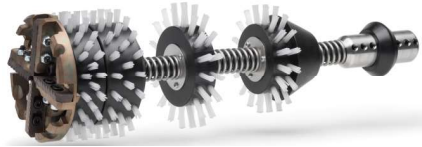

Smart Crusher 6" - 3/4" Shaft

\$2,727.00

1370180150

Liner Remover

For situations where the collapse is in the center or fully collapsed. Makes the initial removal, follow up with Cyclone Premium or Smart Cutter™.

Front Drill Head can be used for liner that has sagged from the top (sold separately 1300215130). For cast iron pipes only.

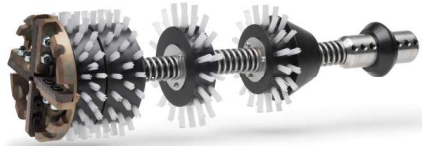

Smart Crusher 8" - 3/4" Shaft

\$3,525.00

1370180200

Liner Remover

For situations where the collapse is in the center or fully collapsed. Makes the initial removal, follow up with Cyclone Premium or Smart Cutter™.

Front Drill Head can be used for liner that has sagged from the top (sold separately 1300215175). For cast iron pipes only.



Smart Crusher 9" - 3/4" Shaft

\$3,742.00

1370180225

Liner Remover

For situations where the collapse is in the center or fully collapsed. Makes the initial removal, follow up with Cyclone Premium or Smart Cutter™.

Front Drill Head can be used for liner that has sagged from the top (sold separately 1300215200). For cast iron pipes only.



Smart Crusher Front Drill Head 4"

\$1,162.00

1300218100

Smart Crusher Spare Part

Includes 4 Blades & 4 Screws. Diameter of the Drill Head 3.3".



Smart Crusher Front Drill Head 6"

\$1,312.00

1300218150

Smart Crusher Spare Part

Includes 4 Blades & 4 Screws. Diameter of the Drill Head 5.1".



Smart Crusher Front Drill Head 8"

\$1,552.00

1300218200

Smart Crusher Spare Part

Includes 4 Blades & 4 Screws. Diameter of the Drill Head: 7".



Smart Crusher Front Drill Head 9"

\$1,642.00

1300218225

Smart Crusher Spare Part

Includes 4 Blades & 4 Screws. Diameter of the Drill Head: 8".



Smart Crusher Blade 4"

\$429.00

900000713

Smart Crusher Spare Part
4pcs per package. Includes screws and nuts.



Smart Crusher Blade 6"

\$444.60

900000663

Smart Crusher Spare Part
4pcs per package. Includes screws and nuts.



Smart Crusher Blade 8"

\$538.20

900000709

Smart Crusher Spare Part
4pcs per package. Includes screws and nuts.



Smart Crusher Blade 9"

\$589.68

900000710

Smart Crusher Spare Part
4pcs per package. Includes screws and nuts.

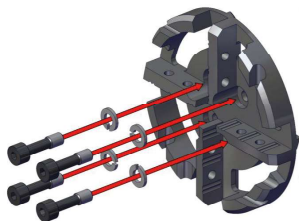

Screws 4": DIN912 M5x18

\$5.25

9990700026

Smart Crusher Spare Part
Includes 8pcs.

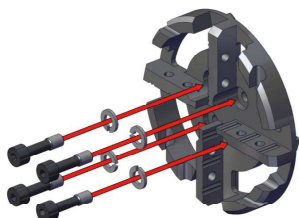

Screws 6, 8 & 9": DIN912 M6x20

\$7.27

1350000140

Smart Crusher Spare Part
Includes 8pcs.



Front Drill Head 3"

\$232.50

1300215060

Spare Drill Head
Can be used with a Smart Crusher body for liner removal, Twister+ body for reinstatements and in the front of the Smart Sweepers. Diameter of the Drill Head: 2.3".



Front Drill Head 4"

\$413.40

1300215085

Spare Drill Head

Can be used with a Smart Crusher body for liner removal, Twister+ body for reinstatement sand in the front of the Smart Sweepers. Diameter of the Drill Head: 3.3".



Front Drill Head 6"

\$491.40

1300215130

Spare Drill Head

Can be used with a Smart Crusher body for liner removal, Twister+ body for reinstatement sand in the front of the Smart Sweepers. Diameter of the Drill Head: 5.1".



Front Drill Head 8"

\$1,014.00

1300215175

Spare Drill Head

Can be used with a Smart Crusher body for liner removal, Twister+ body for reinstatement sand in the front of the Smart Sweepers. Diameter of the Drill Head: 7".



Front Drill Head 9"

\$1,084.20

1300215200

Spare Drill Head

Can be used with a Smart Crusher body for liner removal, Twister+ body for reinstatement sand in the front of the Smart Sweepers. Diameter of the Drill Head: 8".

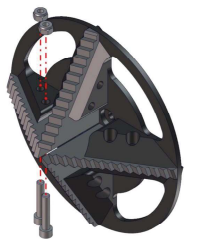

Screws 8-9": DIN912 M6x30

\$7.27

900000723

Front Drill Head Spare Part

Includes 8x DIN912 M6x30 screws.

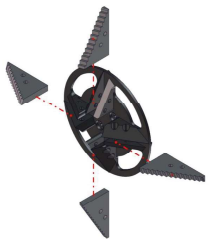

Front Drill Head Blade 8"

\$366.60

900000694

Front Drill Head Spare Part

4x Blades per package. Includes screws and nuts.

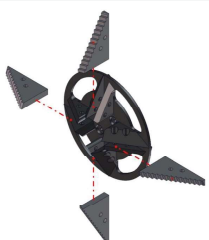

Front Drill Head Blade 9"

\$382.20

900000716

Front Drill Head Spare Part

4x Blades per package. Includes screws and nuts.



Smart Sweeper+ 6" - 3/4" Shaft

\$3,003.00

1360180150

Smart Sweeper+

A self-centralizing and sideways grinding tool for challenging liner removal situations where the collapsed material is around the wall of the pipe. Use with the Front Drill Head to remove collapsed liner, or for situations where too big of a liner has been installed in the pipe.



Smart Sweeper+ 8" - 3/4" Shaft

\$3,510.00

1360180200

Smart Sweeper+

A self-centralizing and sideways grinding tool for challenging liner removal situations where the collapsed material is around the wall of the pipe. Use with the Front Drill Head to remove collapsed liner, or for situations where too big of a liner has been installed in the pipe.



Smart Sweeper+ 9" - 3/4" Shaft

\$3,705.00

1360180225

Smart Sweeper+

A self-centralizing and sideways grinding tool for challenging liner removal situations where the collapsed material is around the wall of the pipe. Use with the Front Drill Head to remove collapsed liner, or for situations where too big of a liner has been installed in the pipe.



Smart Hub Disc 6-9"

\$30.81

1000200059

Smart Sweeper+ Spare Part
Includes screws.



Smart Sweeper+ 6-9" Spare Legs

\$422.50

1360180001

Smart Sweeper+ Spare Part
8x Legs per package. 8 needed.

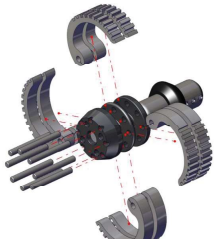

Smart Sweeper+ 6-9" Spare Axle

\$84.00

1390180004

Smart Sweeper+ Spare Part
8x Spare Axles per package. 8 needed.



Twister+ 6" - 3/4" Shaft

\$2,082.60

1230130150

Lateral Cutter

Make the first initial cut with a Twister+ and follow up by grinding remaining edges with the right size Smart Cutter+.



Twister+ 8" - 3/4" Shaft

\$2,441.40

1230175200

Lateral Cutter

Make the first initial cut with a Twister+ and follow up by grinding remaining edges with the right size Smart Cutter+.



Twister+ 9" - 3/4" Shaft

\$2,566.20

1230200225

Lateral Cutter

Make the first initial cut with a Twister+ and follow up by grinding remaining edges with the right size Smart Cutter+.



Twister+ 10" - 3/4" Shaft

\$2,644.20

1230225250

Lateral Cutter

Make the first initial cut with a Twister+ and follow up by grinding remaining edges with the right size Smart Cutter+.

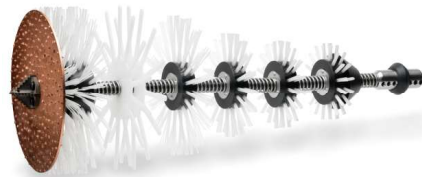

Twister+ 12" - 3/4" Shaft

\$2,698.80

1230275300

Lateral Cutter

Make the first initial cut with a Twister+ and follow up by grinding remaining edges with the right size Smart Cutter+.

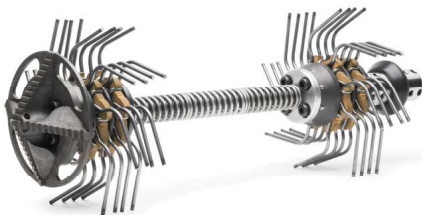

Smart Spider+ 6" - 3/4" Shaft

\$1,537.00

1390180150

Cleaning

For descaling damaged pipes with missing bottoms or holes where typical chains or other descaling methods may be too aggressive, can get stuck in the missing sections or holes or can come out from the pipe. Also good for Fats, Oil & Grease (FOGs).

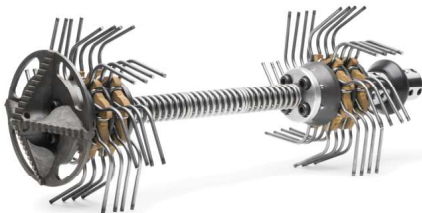

Smart Spider+ 8" - 3/4" Shaft

\$1,942.00

1390180200

Cleaning

For descaling damaged pipes with missing bottoms or holes where typical chains or other descaling methods may be too aggressive, can get stuck in the missing sections or holes or can come out from the pipe. Also good for Fats, Oil & Grease (FOGs).

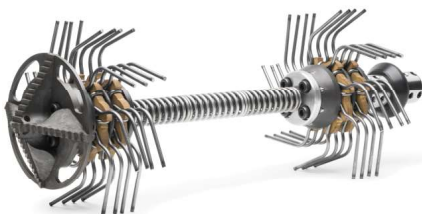

Smart Spider+ 9" - 3/4" Shaft

\$2,145.00

1390180225

Cleaning

For descaling damaged pipes with missing bottoms or holes where typical chains or other descaling methods may be too aggressive, can get stuck in the missing sections or holes or can come out from the pipe. Also good for Fats, Oil & Grease (FOGs).

Smart Hub Disc 6-9"

\$30.81



1000200059
Smart Spider+ Spare Part
Includes screws.

Smart Hub Disc with Hole 6-9"

\$30.81



1000210059
Smart Spider+ Spare Part
Includes screws
Used when the shaft needs to be pushed through the Smart Spider+ hub.

6" Spare Smart Spider Legs

\$66.75



1390180001
Smart Spider+ Spare Part
16 pieces per package.

8" Spare Smart Spider Legs

\$70.10



1390180002
Smart Spider+ Spare Part
16 pieces per package.

9" Spare Smart Spider Legs

\$75.45



1390180003
Smart Spider+ Spare Part
16 pieces per package.

6-9" Spare Smart Spider Axle

\$84.00

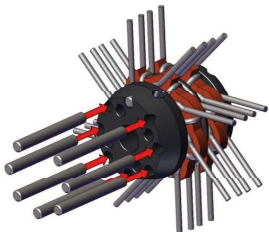

1390180004
Smart Spider+ Spare Part
8 pieces per package. 8 needed.

Smart Spider Rubber Flex

\$95.94

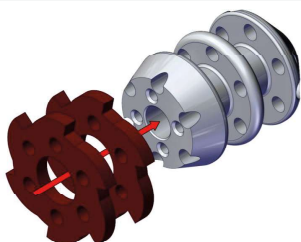

1390180005
Smart Spider+ Spare Part
4 pieces per package. 4 needed.

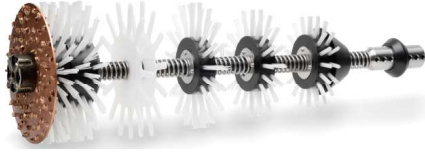

Twister Concrete Remover+ 6"

\$2,238.00

1234130150

Concrete Remover (3/4" Shaft)

For efficient concrete, grout, slurry, & rock removal.



Twister Concrete Remover+ 8"

\$2,597.00

1234175200

Concrete Remover (3/4" Shaft)

For efficient concrete, grout, slurry, & rock removal.



Twister Concrete Remover+ 9"

\$2,722.00

1234200225

Concrete Remover (3/4" Shaft)

For efficient concrete, grout, slurry, & rock removal.

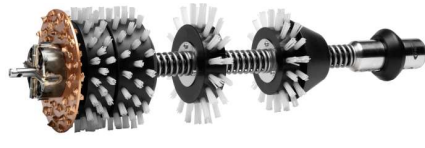

Twister Concrete Remover+ 6" w/Steering Axle

\$2,262.00

1234130150SA

Concrete Remover (3/4" Shaft)

For efficient concrete, grout & slurry removal where pipe is less than 50% full of material and you have access points from both ends. Feed a pulling cable through the pipe and attach it to steering axle on the Twister.

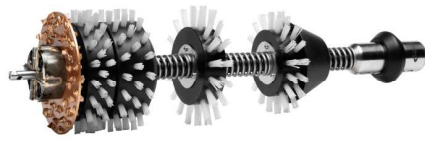

Twister Concrete Remover+ 8" w/Steering Axle

\$2,580.00

1234175200SA

Concrete Remover (3/4" Shaft)

For efficient concrete, grout & slurry removal where pipe is less than 50% full of material and you have access points from both ends. Feed a pulling cable through the pipe and attach it to steering axle on the Twister.

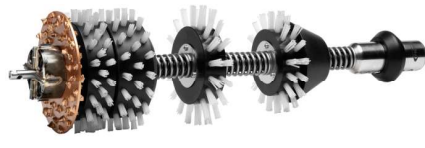

Twister Concrete Remover+ 9" w/Steering Axle

\$2,699.00

1234200225SA

Concrete Remover (3/4" Shaft)

For efficient concrete, grout & slurry removal where pipe is less than 50% full of material and you have access points from both ends. Feed a pulling cable through the pipe and attach it to steering axle on the Twister.



Front Drill Head 60 for Concrete Remover+

\$328.00

1300215057

Concrete Remover (3/4" Shaft)

Used with Concrete Remover+ with Front Metal Panels
Diameter of the drill head is 2.36".



Front Metal Panel 5.1" - Twister Concrete Remover+

\$247.50

1210510130

Concrete Remover (3/4" Shaft)
Spare part. Panel thickness: 3mm. Grit 6.
For Twister Concrete Remover+ 6".



Front Metal Panel 6.9" - Twister Concrete Remover+

\$283.50

1210510175

Concrete Remover (3/4" Shaft)
Spare part. Panel thickness: 3mm. Grit 6.
For Twister Concrete Remover+ 8".



Front Metal Panel 8" - Twister Concrete Remover+

\$322.50

1210510200

Concrete Remover (3/4" Shaft)
Spare part. Panel thickness: 3mm. Grit 6.
For Twister Concrete Remover+ 9".



Original Premium Chain 4" - 3/4" Shaft

\$191.45

1380185100U

Premium (3/4" Shaft)
Larger and heavier U carbide (7-ridge) makes it stronger and faster than any other chain on the market. A versatile tool for cast iron pipes. For tough descaling, hard deposits and removing residual concrete or failed liner, including inconsistencies, wrinkles and remains.



Original Premium Chain 5-6" - 3/4" Shaft

\$234.40

1380185150U

Premium (3/4" Shaft)
Larger and heavier U carbide (7-ridge) makes it stronger and faster than any other chain on the market. A versatile tool for cast iron pipes. For tough descaling, hard deposits and removing residual concrete or failed liner, including inconsistencies, wrinkles and remains.



Original Premium Chain 8" - 3/4" Shaft

\$277.90

1380185200U

Premium (3/4" Shaft)
Larger and heavier U carbide (7-ridge) makes it stronger and faster than any other chain on the market. A versatile tool for cast iron pipes. For tough descaling, hard deposits and removing residual concrete or failed liner, including inconsistencies, wrinkles and remains.



Original Premium Chain 9-10" - 3/4" Shaft

\$369.15

1380185250U

Premium (3/4" Shaft)
Larger and heavier U carbide (7-ridge) makes it stronger and faster than any other chain on the market. A versatile tool for cast iron pipes. For tough descaling, hard deposits and removing residual concrete or failed liner, including inconsistencies, wrinkles and remains.



Original Premium Chain 12" - 3/4" Shaft

\$428.60

1380185300U

Premium (3/4" Shaft)

Larger and heavier U carbide (7-ridge) makes it stronger and faster than any other chain on the market. A versatile tool for cast iron pipes. For tough descaling, hard deposits and removing residual concrete or failed liner, including inconsistencies, wrinkles and remains.



Cyclone Premium Chain 4" - 3/4" Shaft

\$251.16

1381185100U

Premium (3/4" Shaft)

Larger and heavier U carbide (7-ridge) makes it stronger and faster than any other chain in the market. No need to adjust, the centrifugal force centers the tool inside the pipe. For tough descaling, hard deposits and removing residual concrete or failed liner.



Cyclone Premium Chain 5" - 3/4" Shaft

\$275.34

1381185125U

Premium (3/4" Shaft)

Larger and heavier U carbide (7-ridge) makes it stronger and faster than any other chain in the market. No need to adjust, the centrifugal force centers the tool inside the pipe. For tough descaling, hard deposits and removing residual concrete or failed liner.



Cyclone Premium Chain 6" - 3/4" Shaft

\$287.25

1381185150U

Premium (3/4" Shaft)

Larger and heavier U carbide (7-ridge) makes it stronger and faster than any other chain in the market. No need to adjust, the centrifugal force centers the tool inside the pipe. For tough descaling, hard deposits and removing residual concrete or failed liner.



Cyclone Premium Chain 8" - 3/4" Shaft

\$327.00

1381185200U

Premium (3/4" Shaft)

Larger and heavier U carbide (7-ridge) makes it stronger and faster than any other chain in the market. No need to adjust, the centrifugal force centers the tool inside the pipe. For tough descaling, hard deposits and removing residual concrete or failed liner.



Cyclone Premium Chain 9" - 3/4" Shaft

\$378.20

1381185225U

Premium (3/4" Shaft)

Larger and heavier U carbide (7-ridge) makes it stronger and faster than any other chain in the market. No need to adjust, the centrifugal force centers the tool inside the pipe. For tough descaling, hard deposits and removing residual concrete or failed liner.



Cyclone Premium Chain 10" - 3/4" Shaft

\$431.60

1381185250U

Premium (3/4" Shaft)

Larger and heavier U carbide (7-ridge) makes it stronger and faster than any other chain in the market. No need to adjust, the centrifugal force centers the tool inside the pipe. For tough descaling, hard deposits and removing residual concrete or failed liner.

Cyclone Premium Chain 12" - 3/4" Shaft

\$488.45



1381185300U

Premium (3/4" Shaft)

Larger and heavier U carbide (7-ridge) makes it stronger and faster than any other chain in the market. No need to adjust, the centrifugal force centers the tool inside the pipe. For tough descaling, hard deposits and removing residual concrete or failed liner.

Tornado Original Chain 4" - 3/4" Shaft

\$117.00



1380185100T

Tornado (3/4" Shaft)

Standard Chains for use with the Maxi Power+. With strong hardened stainless steel links instead of carbides these chains are long-lasting and ideal for descaling and removing hard deposits inside cast iron pipes.

Tornado Original Chain 5-6" - 3/4" Shaft

\$130.00



1380185150T

Tornado (3/4" Shaft)

Standard Chains for use with the Maxi Power+. With strong hardened stainless steel links instead of carbides these chains are long-lasting and ideal for descaling and removing hard deposits inside cast iron pipes.

Tornado Original Chain 8" - 3/4" Shaft

\$139.00



1380185200T

Tornado (3/4" Shaft)

Standard Chains for use with the Maxi Power+. With strong hardened stainless steel links instead of carbides these chains are long-lasting and ideal for descaling and removing hard deposits inside cast iron pipes.

Tornado Original Chain 9-10" - 3/4" Shaft

\$151.00



1380185250T

Tornado (3/4" Shaft)

Standard Chains for use with the Maxi Power+. With strong hardened stainless steel links instead of carbides these chains are long-lasting and ideal for descaling and removing hard deposits inside cast iron pipes.

Tornado Original Chain 12" - 3/4" Shaft

\$171.00



1380185300T

Tornado (3/4" Shaft)

Standard Chains for use with the Maxi Power+. With strong hardened stainless steel links instead of carbides these chains are long-lasting and ideal for descaling and removing hard deposits inside cast iron pipes.

Tornado Cyclone Chain 6" - 3/4" Shaft

\$154.00



1381185150T

Tornado (3/4" Shaft)

Standard Chains for use with the Maxi Power+. With strong hardened stainless steel links instead of carbides these chains are long-lasting and ideal for descaling and removing hard deposits inside cast iron pipes.



Tornado Cyclone Chain 8" - 3/4" Shaft

\$167.25

1381185200T

Tornado (3/4" Shaft)

Standard Chains for use with the Maxi Power+. With strong hardened stainless steel links instead of carbides these chains are long-lasting and ideal for descaling and removing hard deposits inside cast iron pipes.



Tornado Cyclone Chain 9" - 3/4" Shaft

\$180.60

1381185225T

Tornado (3/4" Shaft)

Standard Chains for use with the Maxi Power+. With strong hardened stainless steel links instead of carbides these chains are long-lasting and ideal for descaling and removing hard deposits inside cast iron pipes.



Tornado Cyclone Chain 10" - 3/4" Shaft

\$192.00

1381185250T

Tornado (3/4" Shaft)

Standard Chains for use with the Maxi Power+. With strong hardened stainless steel links instead of carbides these chains are long-lasting and ideal for descaling and removing hard deposits inside cast iron pipes.



Tornado Cyclone Chain 12" - 3/4" Shaft

\$212.00

1381185300T

Tornado (3/4" Shaft)

Standard Chains for use with the Maxi Power+. With strong hardened stainless steel links instead of carbides these chains are long-lasting and ideal for descaling and removing hard deposits inside cast iron pipes.



Shaft Connector 3/4" to 3/4"

\$121.68

1313002185

Maxi Power+ Spare Part



Strain Relief Spring Maxi Power+

\$123.24

9570000034-2

Maxi Power+ Spare Part



Maxi Power+ Replacement Shaft 67ft

\$1,192.50

1312021180020

Maxi Power+ Spare Part



Maxi Power+ Shaft Extension 36ft

\$640.00

1312021180011
Maxi Power+ Spare Part



Sleeve for 3/4" Shaft Outer Casing

\$97.50

93212520180SB
Maxi Power+ Spare Part

DON'T LIMIT YOURSELF! GO FURTHER WITH PICOTE ROBO TOOLS

Larger pipes require bigger tools and a longer reach. When this is the case, Picote has a robotic tool range that is designed to be fitted to the world renowned Schwalm Talpa Robot. Together with Schwalm's engineering team, Picote has created tools that can perform challenging tasks such as grinding, cutting and cleaning. It is also possible to grab lost items or remove obstructions with the Grabber pincher jaws mounted on board with an HD camera for precision work.

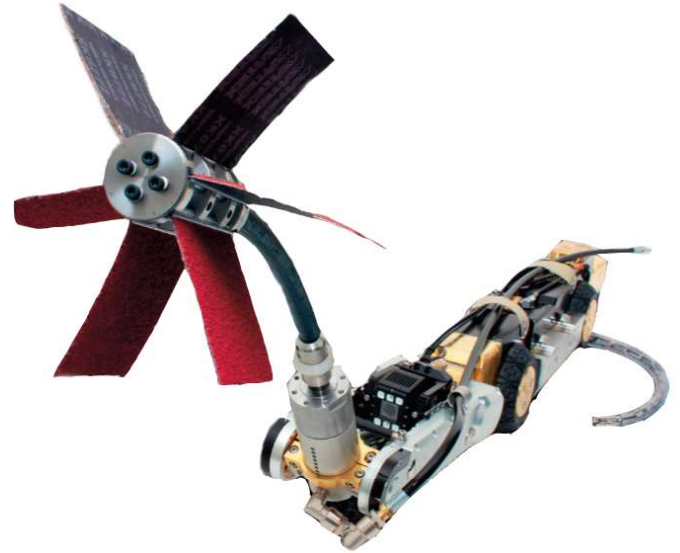

PICOTE ROBOT TOOLS FOR SCHWALM ROBOTS

PICOTE ROBO TOOLS

- Robo Smart Cutter™
- Robo Cyclone
- Robo Spider
- Robo Grabber





Robo Shaft Connector M14 / 1/2"

\$151.32

1313004125

Shaft Connector

Combine Picote tools with the Schwalm Robotic System to create a powerful and versatile solution. Go further in distance: 1200ft. Provide specialty services to the oil industry and for water & sewer mains.



Robo Shaft Connector M14 / 3/4"

\$168.48

1313004185

Shaft Connector

Combine Picote tools with the Schwalm Robotic System to create a powerful and versatile solution. Go further in distance: 1200ft. Provide specialty services to the oil industry and for water & sewer mains.



Robo Cyclone 6"

\$620.88

1420125150

Cleaning Chain

Descale pipe for long distances.
Mount the Robo Cyclone on a robot for efficient cleaning and grinding.



Robo Cyclone 8"

\$694.20

1420125200

Cleaning Chain

Descale pipe for long distances.
Mount the Robo Cyclone on a robot for efficient cleaning and grinding.



Robo Cyclone 10"

\$769.08

1420125250

Cleaning Chain

Descale pipe for long distances.
Mount the Robo Cyclone on a robot for efficient cleaning and grinding.



Robo Cyclone 12"

\$862.68

1420125300

Cleaning Chain

Descale pipe for long distances.
Mount the Robo Cyclone on a robot for efficient cleaning and grinding.

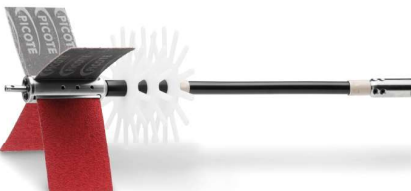

Robo Smart Cutter 6"

\$538.20

1421125150

Smart Cutter™

Use the robot cutting ball and then follow up with the Smart Cutter™. Grind away seams, welding beads and other inconsistencies in the pipe. Steering option included.

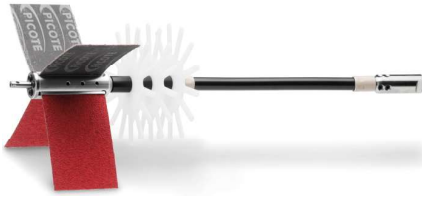

Robo Smart Cutter 8"

\$569.40

1421125200

Smart Cutter™

Use the robot cutting ball and then follow up with the Smart Cutter™. Grind away seams, welding beads and other inconsistencies in the pipe. Steering option included.



Robo Smart Cutter 10"

\$595.92

1421125250

Smart Cutter™

Use the robot cutting ball and then follow up with the Smart Cutter™. Grind away seams, welding beads and other inconsistencies in the pipe. Steering option included.

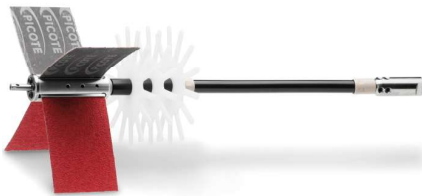

Robo Smart Cutter 12"

\$616.20

1421125300

Smart Cutter™

Use the robot cutting ball and then follow up with the Smart Cutter™. Grind away seams, welding beads and other inconsistencies in the pipe. Steering option included.



Robo Grabber

\$1,477.00

1423125010

Grabber

Add a grabbing capability to your robot to remove items from hard to reach places. Reclaim a tool or item, weighing up to 77lb. Grab lost items or remove obstructions with the Grabber pincher claws mounted on board with a HD camera for precision work.



Robo Smart Spider 6"

\$975.00

1422125150

Smart Spider

Descale fragile pipes with ease with your multi-use robot. Gentle on brass connections in water mains.

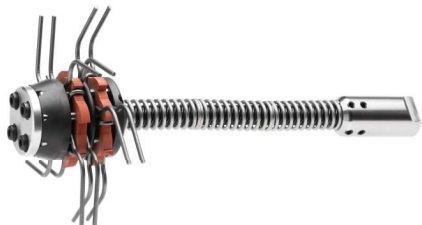

Robo Smart Spider 8"

\$1,131.00

1422125200

Smart Spider

Descale fragile pipes with ease with your multi-use robot. Gentle on brass connections in water mains.



DON'T WASTE TIME AT THE WORKSITE!

Picote offers a range of quality 'Additional Tools' selected for durability and longevity. Each product has been carefully chosen to complement your Picote Miller or Tools. Save time with Sheath Cutters, Hex Keys, Shaft Rounders, Pliers and more to get the job done!



ADDITIONAL TOOLS

SHAFT ROUNDER

The Flexible Shaft should be inspected before every use. If damaged, the Shaft should be trimmed back. The Shaft Rounder is then used to smooth the end of the flexible shaft, preventing the user from being cut by the otherwise sharp metal edge. This also prevents the Shaft from unraveling and ensures good fit for the tools.





Shaft Rounder

\$ 262.50

1350000018

Rounds sharp edges of the shaft after trimming.



Sheath Cutter 1

\$ 95.58

1350000006

Used when there is no shaft in the outer casing.



Sheath Cutter 2 (Shaft inside outer casing)

\$ 68.98

1350000011

Used when there is shaft inside the outer casing.



Cutter for Side Grinding Panels

\$ 52.15

1350000012

Resize panels when needed. Cut off worn edges.



Combo Hex Key 1-6mm

\$ 15.46

1350000013

For safely tightening 1-6mm screws.



Hex Key 4mm, 3mm & 2.5mm

1350000008

For safely tightening 4mm screws.

\$ 23.91

1350000009

For safely tightening 3mm screws.

\$ 23.07

1350000010

For safely tightening 2.5mm screws.

\$ 20.50



HANDS-ON CERTIFICATION COURSES

Picote has a range of face-to-face training options to help you get the most out of your equipment:

- **Cutting and Cleaning (1-2 days)**
- **Maxi Miller Power+ Certification (1 day)**
- **Picote Brush Coating™ Certified Installer (2 days)**
- **Customized Training Courses** which can be tailored to suit your needs. Get the most out of your Picote Miller and learn the full range of tools and possibilities.

Our new Training Center in Phoenix, Arizona has a 2 story structure with a pipework configuration designed to replicate real-life scenarios.

TRAINING CENTERS

PHOENIX, AZ | CUSTOMER LOCATIONS

VIRTUAL COURSES

Our Team of Technical Experts are available wherever you are in the world! We can offer a range of virtual training programs to meet your needs. With a balanced program of presentations, live demos and an in-depth Q&A, you can learn to get the most out of your Picote equipment in the convenience of your own location.





**For
More
information,
please
contact:**

Jetter Depot

866-553-8837 or 866-5-JETTER

sales@JetterDepot.com

Follow Picote on

