



Off Grid Solar Inverter User Manual

RS-H3000-24
RS-H3000-48

TABLE OF CONTENTS

1. INFORMATION ON THIS MANUAL.....	01
2. INTRODUCTION.....	01
3. INSTALLATION.....	03
4. OPERATION.....	09
5. PARALLEL INSTALLATION GUIDE.....	20
6. FAULT REFERENCE CODE.....	30
7. WARNING INDICATOR.....	31
8. BATTERY EQUALIZATION.....	32
9. SPECIFICATIONS.....	33
10. TROUBLE SHOOTING.....	36

INFORMATION ON THIS MANUAL

Validity

This manual is valid for the following devices:

- RS-H3000-24
- RS-H3000-48

Scope

This manual describes the assembly, installation, operation and troubleshooting of this unit. Please read this manual carefully before installations and operations.

Target Group

This document is intended for qualified persons and end users. Tasks that do not require any particular qualification can also be performed by end users. Qualified persons must have the following skills:

- Knowledge of how an inverter works and is operated
- Training in how to deal with the dangers and risks associated with installing and using electrical devices and installations
- Training in the installation and commissioning of electrical devices and installations
- Knowledge of the applicable standards and directives
- Knowledge of and compliance with this document and all safety information

Safety Instructions

⚠ WARNING: This chapter contains important safety and operating instructions. Read and keep this manual for future reference.

1. Before using the unit, read all instructions and caution marks on the unit, understand the batteries and all appropriate sections of this manual.
2. Do not disassemble the unit. Take it to a qualified service center when service or repair is required. Incorrect re-assembly may result in a risk of electric shock or fire.
3. To reduce risk of electric shock, disconnect all wiring before attempting any maintenance or cleaning. Turning off the unit will not reduce this risk.
4. Be very cautious when working with metal tools on or around batteries. A potential risk, such as dropping a tool to spark or short circuit batteries or other electrical parts, could cause an explosion.
5. For optimum operation of this off grid solar inverter, please follow required spec to select appropriate cable size. It's very important to correctly operate this off grid solar inverter.
6. Please strictly follow installation procedure when you want to disconnect AC or DC terminals. Please refer to INSTALLATION section of this manual for the details.
7. GROUNDING INSTRUCTIONS -This off grid solar inverter should be connected to a permanent grounded wiring system. Be sure to comply with local requirements and regulation to install this inverter.
8. Fuses with provided standard are provided as over-current protection for the battery supply.

⚠ CAUTION: Only qualified personnel can install this device with battery.

⚠ Never cause AC output and DC input short circuited. Do not connect to the mains when DC input short circuits. Never charge a frozen battery.

⚠ Warning!! Only qualified service persons are able to service this device. If errors still persist after following troubleshooting table, please send this off grid solar inverter back to local dealer or service center for Maintenance.

INTRODUCTION



This is a multifunctional off grid solar inverter, integrated with a MPPT solar charge controller, a high frequency pure sine wave inverter and a UPS function module in one machine, which is perfect for off grid backup power and self-consumption applications. The transformerless design provides reliable power conversion in compact size.

The whole system also need other devices to achieve complete running such as PV modules, generator, or utility grid. Please consult with your system integrator for other possible system architectures depending on your requirements. The WiFi/GPRS module is a plug-and-play monitoring device to be installed on the inverter. With this device, users can monitor the status of the PV system from the mobile phone or from the website anytime anywhere.

Features

- 24V/48V battery system
- Pure sine wave output 3KW
- Inbuilt MPPT 80A
- High frequency inverter with small size and light weight
- Overload, short circuit and deep discharge protection
- Compatible to mains voltage or generator power
- Parallel operation up to 6 unit
- With CAN/RS485 for BMS communication
- WIFI / GPRS remote monitoring (optional)

Product Overview

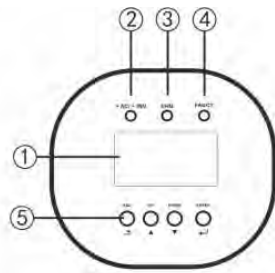
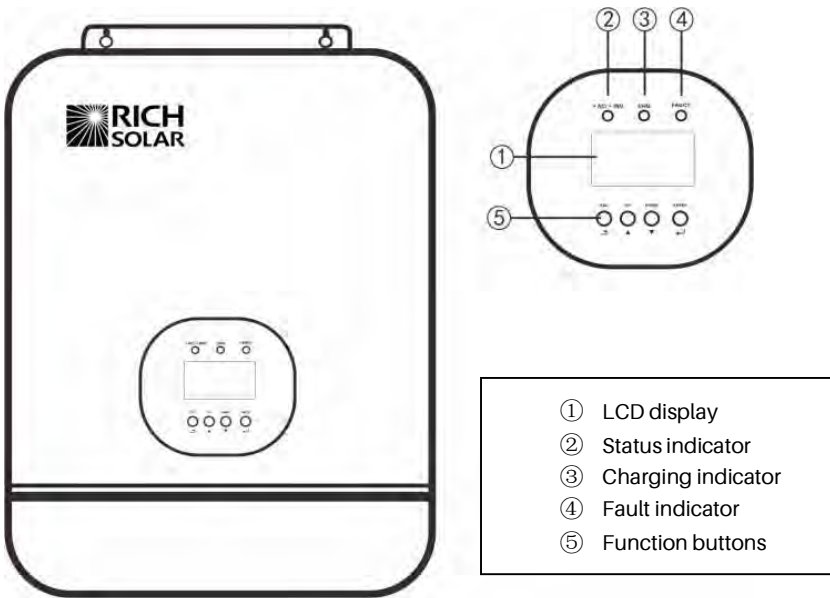

- ① LCD display
- ② Status indicator
- ③ Charging indicator
- ④ Fault indicator
- ⑤ Function buttons

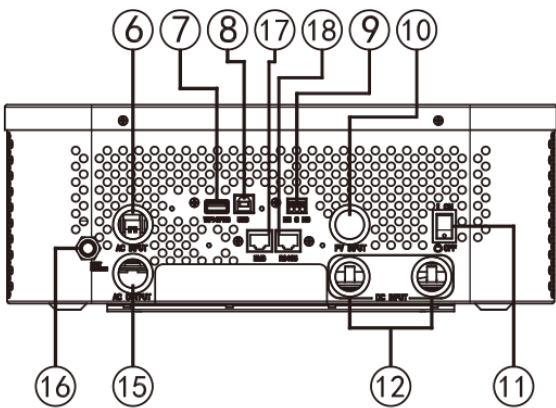

Single Model

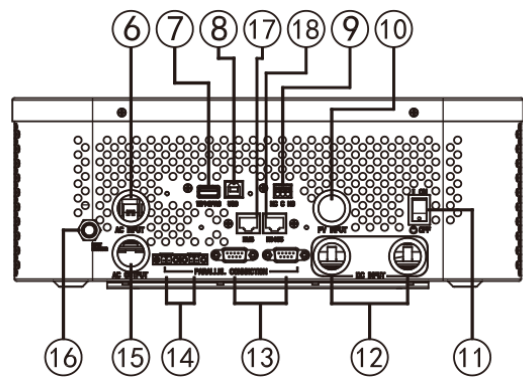

Parallel Model

- ⑥ AC input
- ⑧ USB communication port
- ⑩ PV input
- ⑫ Battery input
- ⑭ Current sharing ports (only for parallel model)
- ⑯ Circuit breaker
- ⑰ RS485 communication port (for expansion)

- ⑦ WiFi/GPRS communication port
- ⑨ Dry contact
- ⑪ Power on/off switch
- ⑬ Parallel communication ports (only for parallel model)
- ⑮ AC output
- ⑰ BMS communication port (support CAN/RS485 protocol)

INSTALLATION

Unpacking and Inspection

Before installation, please inspect the unit. Be sure that nothing inside the package is damaged. You should have received the following items in the package:

- The unit x 1
- User manual x 1
- USB Communication cable x 1
- Software CD x 1
- Current sharing cable (parallel model available)
- Parallel communication cable (parallel model available)

Preparation

Before connecting all wiring, please take off bottom cover by removing two screws as shown below.

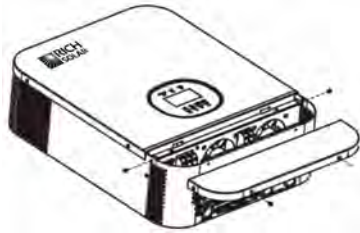

Mounting the Unit

Consider the following points before selecting where to install:

- Do not mount the inverter on flammable construction materials.
- Mount on a solid surface
- Install this inverter at eye level in order to allow the LCD display to be read at all times.
- The ambient temperature should be between 0°C and 55°C to ensure optimal operation.
- The recommended installation position is to be adhered to the wall vertically.
- Be sure to keep other objects and surfaces as shown in the right diagram to guarantee sufficient heat dissipation and to have enough space for removing wires.

⚠ SUITABLE FOR MOUNTING ON CONCRETE OR OTHER NON-COMBUSTIBLE SURFACE ONLY.

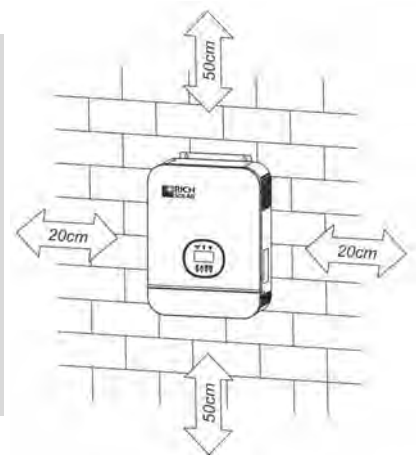

Install the unit by screwing three screws. It's recommended to use M4 or M5 screws.

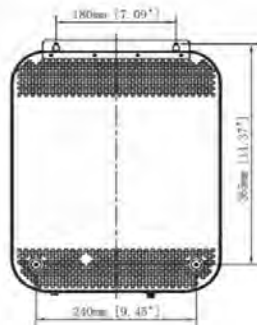
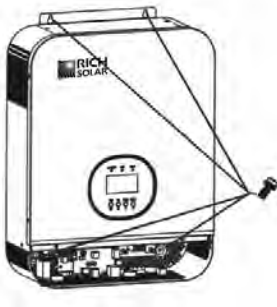

Battery Connection

Lead-acid Battery Connection

User can choose proper capacity lead acid battery with a nominal voltage at 48V for 48V model and at 24V for 24V model. You need to choose battery type as "AGM(default) or FLD".

⚠ CAUTION: For safety operation and regulation compliance, it's requested to install a separate DC over-current protector or disconnect device between battery and inverter. It may not be requested to have a disconnect device in some applications, however, it's still requested to have over-current protection installed. Please refer to typical amperage in below table as required fuse or breaker size.

⚠ WARNING! All wiring must be performed by a qualified person.

⚠ WARNING! It's very important for system safety and efficient operation to use appropriate cable for battery connection. To reduce risk of injury, please use the proper recommended cable and terminal size as below.

Ring terminal:

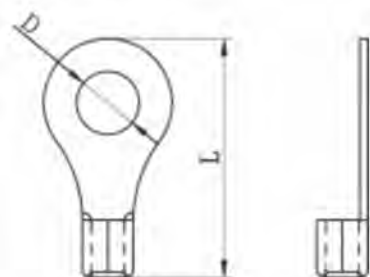

Recommended battery cable and terminal size:

Model	Maximum Amperage	Battery capacity	Wire Size	Ring Terminal			Torque value
				Cable mm ²	Dimensions		
					D (mm)	L (mm)	
RS-H3000-24	141A	200AH	1*2AWG	38	6.4	39.2	2~ 3 Nm
			2*6AWG	28	6.4	33.2	
RS-H3000-48	71A	100AH	1*4AWG	22	6.4	39.2	2~ 3 Nm
		200AH	2*8AWG	16	6.4	33.2	

Note: for lead acid battery, the recommended charge current is 0.2C(C→battery capacity)

Please follow below steps to implement battery connection:

1. Assemble battery ring terminal based on recommended battery cable and terminal size.
2. Connect all battery packs as units requires. It's suggested to connect at least 100Ah capacity battery for 3KVA/48V model and at least 200Ah capacity battery for 3KVA/24V model.
3. Insert the ring terminal of battery cable flatly into battery connector of inverter and make sure the bolts are tightened with torque of 2-3 Nm. Make sure polarity at both the battery and the inverter/charge is correctly connected and ring terminals are tightly screwed to the battery terminals.

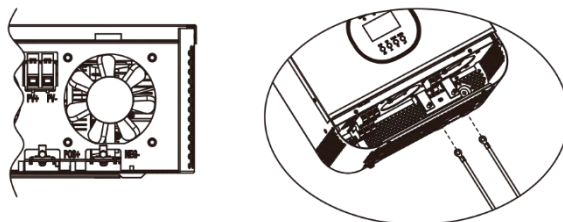

WARNING: Shock Hazard

Installation must be performed with care due to high battery voltage in series.



CAUTION!! Do not place anything between the flat part of the inverter terminal and the ring terminal. Otherwise overheating may occur.

CAUTION!! Do not apply anti-oxidant substance on the terminals before terminals are connected tightly.

CAUTION!! Before making the final DC connection or closing DC breaker/disconnector, be sure positive (+) must be connected to positive (+) and negative (-) must be connected to negative (-).

Lithium Battery Connection

If choosing lithium battery for the inverter, you are allowed to use the lithium battery only which have configured. There're two connectors on the lithium battery, RJ45 port of BMS and power cable.

Please follow below steps to implement lithium battery connection:

1. Assemble battery ring terminal based on recommended battery cable and terminal size (same as Lead acid, see section Lead-acid Battery connection for details).
2. Insert the ring terminal of battery cable flatly into battery connector of inverter and make sure the bolts are tightened with torque of 2-3Nm. Make sure polarity at both the battery and the inverter/charge is correctly connected and ring terminals are tightly screwed to the battery terminals.
3. Connect the end of RJ45 of battery to BMS communication port(RS485 or CAN) of inverter.

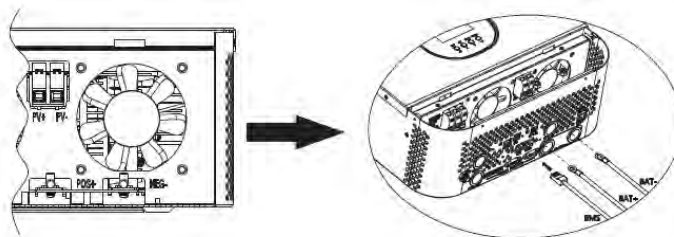

4. The other end of RJ45 insert to battery communication port(RS485 or CAN).

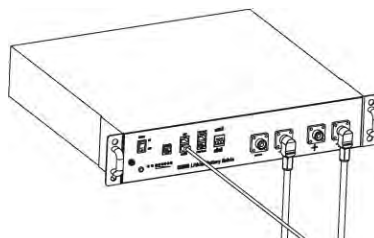

Note: If choosing lithium battery, make sure to connect the BMS communication cable between the battery and the inverter. You need to choose battery type as "lithium battery".

Lithium battery communication and setting

In order to communicate with battery BMS, you should set the battery type to "LI" in Program 5. Then the LCD will switch to Program 36, which is to set the protocol type. There are several protocols in the inverter. Please consult with supplier first before you choosing the battery model.

1. Connect the end of RJ45 of battery to BMS communication port of inverter

Make sure the lithium battery BMS port connects to the inverter is Pin to Pin, the inverter BMS port and RS485 port pin assignment shown as below:

Pin number	BMS port	RS485 port (for expansion)
1	RS485B	RS485B
2	RS485A	RS485A
3	--	--
4	CANH	--
5	CANL	--
6	--	--
7	--	--
8	--	--

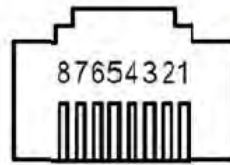

2. LCD setting

To connect battery BMS, need to set the battery type as "LI" in Program 05.

After set "LI" in Program 05, it will switch to Program 36 to choose battery type. There will be some options under Program 36.

05	Battery type	AGM (default) AGM 05	Flooded FLD 05
		Lithium (only suitable when communicated with BMS) LI 05	
		User-Defined USE 05 If "User-Defined" is selected, battery charge voltage and low DC cut-off voltage can be set up in program 19, 20 and 21.	
		User-Defined 2 (suitable when lithium battery without BMS communication) US2 05 If "User-Defined 2" is selected, battery charge voltage and low DC cut-off voltage can be set up in program 19, 20 and 21. It is recommended to set to the same voltage in program 19 and 20 (full charging voltage point of lithium battery). The inverter will stop charging when the battery voltage reaches this setting.	

36	RS485 Communication protocol	Protocol 1	PtC LO1 36
		Protocol 2	PtC LO2 36
		⋮	⋮

	CAN Communication protocol	Protocol 50	PtC L50 36
		Protocol 51	PtC L51 36
		Protocol 52	PtC L52 36
		⋮ ⋮ ⋮	⋮ ⋮ ⋮
		Protocol 99	PtC L99 36

Note: When the battery type set to Li, the setting option 12, 13, 21 will change to display percent.

Note: When the battery type set as "LI", the Maximum charge current can't be modified by the user. When the communication fail, the inverter will cut off output.

12	Setting SOC point back to utility source when selecting "SBU priority" or "Solar first" in program 01	50% 12 Default 50%, 6%~95% Settable
13	Setting SOC point back to battery mode when selecting "SBU priority" or "Solar first" in program 01	95% 13 Default 95%, 10%~100% Settable
21	Low DC Cut-off SOC. If self-defined is selected in program 5, this program can be set up	20% 21 Default 20%, 5%~50% Settable

Note: Any questions about communicating with BMS, please consult with manufacturer.

3. Communicating with battery BMS in parallel system

If need to use communicate with BMS in a parallel system, you should make sure to connect the BMS communication cable between the battery and one inverter of the parallel system. It's recommended to connect to the master inverter of the parallel system.

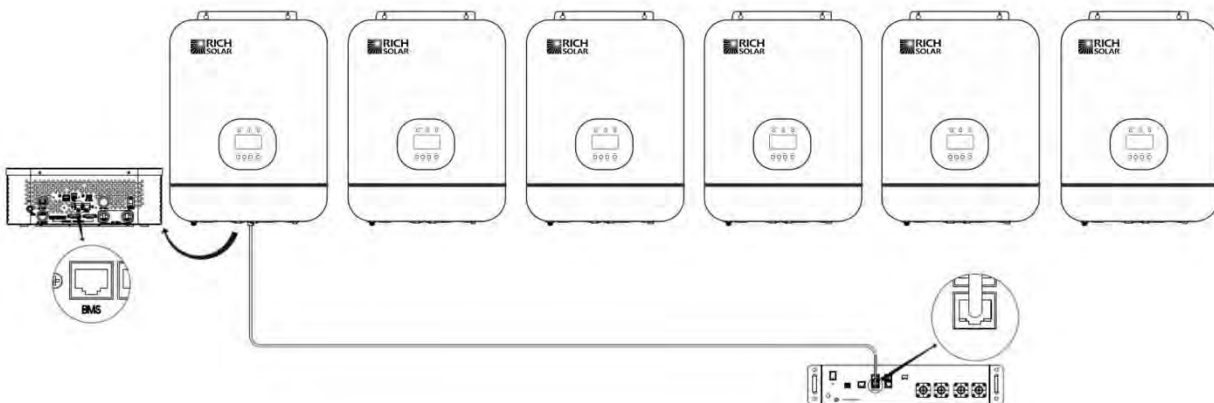

AC Input/Output Connection

CAUTION!! Before connecting to AC input power source, please install a separate AC breaker between inverter and AC input power source. This will

ensure the inverter can be securely disconnected during maintenance and fully protected from over current of AC input. The recommended spec of AC breaker is 40A for 3KVA.

CAUTION!! There are two terminal blocks with "IN" and "OUT" markings. Please do NOT mis-connect input and output connectors.

WARNING! All wiring must be performed by a qualified personnel.

WARNING! It's very important for system safety and efficient operation to use appropriate cable for AC input connection. To reduce risk of injury, please use the proper recommended cable size as below.

Suggested cable requirement for AC wires

Model	Gauge	Torque Value
RS-H3000	8 AWG	1.4~ 1.6 Nm

Please follow below steps to implement AC input/output connection:

1. Before making AC input/output connection, be sure to open DC protector or disconnecter first.
2. Remove insulation sleeve 10mm for six conductors. And shorten phase L and neutral conductor N 3 mm.
3. Insert AC input wires according to polarities indicated on terminal block and tighten the terminal screws. Be sure to connect PE protective conductor  first.

 → **Ground (yellow-green)**

L → **LINE (brown or black)**

N → **Neutral (blue)**

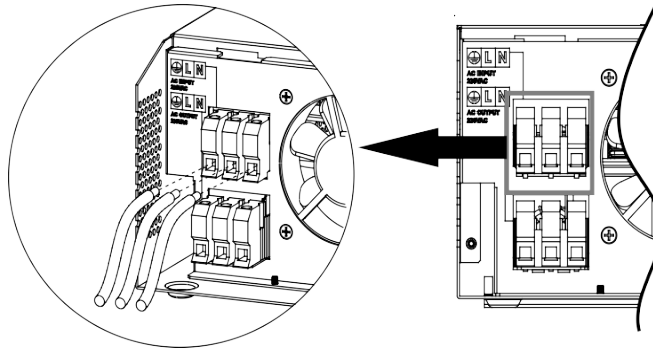

 **WARNING:** Be sure that AC power source is disconnected before attempting to hardwire it to the unit.

4. Then, insert AC output wires according to polarities indicated on terminal block and tighten terminal screws. Be sure to connect PE protective conductor  first.

 → **Ground (yellow-green)**

L → **LINE (brown or black)**

N → **Neutral (blue)**

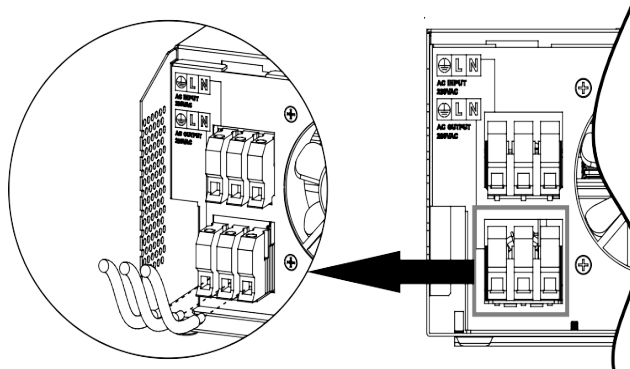

5. Make sure the wires are securely connected.

CAUTION: Important

Be sure to connect AC wires with correct polarity. If L and N wires are connected reversely, it may cause utility short-circuited when these inverters are worked in parallel operation.

CAUTION: Appliances such as air conditioner are required at least 2~3 minutes to restart because it's required to have enough time to balance refrigerant gas inside of circuits. If a power shortage occurs and recovers in a short time, it will cause damage to your connected appliances. To prevent this kind of damage, please check with manufacturer of air conditioner that if it's equipped with time-delay function before installation. Otherwise, this off grid solar inverter will trig overload fault and cut off output to protect your appliance but sometimes it still causes internal damage to the air conditioner.

PV Connection

CAUTION: Before connecting to PV modules, please install separately a DC circuit breaker between inverter and PV modules.

WARNING! All wiring must be performed by a qualified personnel.

WARNING! It's very important for system safety and efficient operation to use appropriate cable for PV module connection. To reduce risk of injury, please use the proper recommended cable size as below.

Model	Typical Amperage	Cable Size	Torque
RS-H3000	80A	6 AWG	1.4~1.6 Nm

PV Module Selection:

When selecting proper PV modules, please be sure to consider below parameters:

1. Open circuit Voltage (Voc) of PV modules not exceeds max. PV array open circuit voltage of inverter.
2. Open circuit Voltage (Voc) of PV modules should be higher than min. battery voltage.

Solar Charging Mode		
INVERTER MODEL	RS-H3000-24	RS-H3000-48
Max. PV Array Open Circuit Voltage	145Vdc	145Vdc
PV Array MPPT Voltage Range	30~115Vdc	60~115Vdc
Min. battery voltage for PV charge	17Vdc	34Vdc

Please follow below steps to implement PV module connection:

1. Remove insulation sleeve 10 mm for positive and negative conductors.
2. Check correct polarity of connection cable from PV modules and PV input connectors. Then, connect positive pole (+) of connection cable to positive pole (+) of PV input connector. Connect negative pole (-) of connection cable to negative pole (-) of PV input connector.

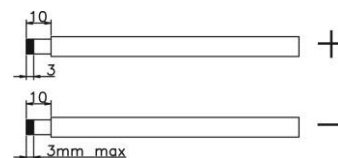
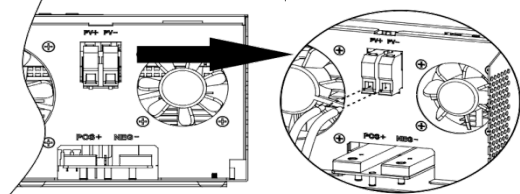

3. Make sure the wires are securely connected.

Final Assembly

After connecting all wiring, please put bottom cover back by screwing two screws as shown below.

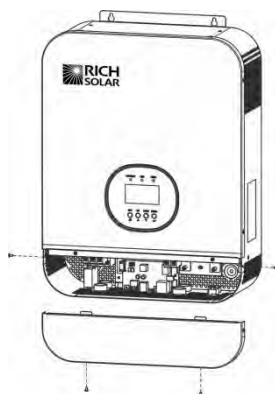

Communication Connection

Please use supplied communication cable to connect to inverter and PC. Insert bundled CD into a computer and follow on-screen instruction to install the monitoring software. For the detailed software operation, please check user manual of software inside of CD.

Dry Contact Signal

There is one dry contact(3A/250VAC) available on the rear panel. It could be used to deliver signal to external device when battery voltage reaches warning level.

Unit Status	Condition		Dry contact port:		
			NC & C	NO & C	
Power Off	Unit is off and no output is powered		Close	Open	
Power On	Output is powered from Utility		Close	Open	
	Output is powered from Battery or Solar	Program 01 set as Utility first	Battery voltage (SOC) < Low DC warning voltage(SOC)	Open	Close
		Program 01 set as SBU or Solar first	Battery voltage (SOC) > Setting value in Program 12	Open	Close
		Program 01 set as Utility first	Battery voltage(SOC) > Setting value in Program 13 or battery charging reaches floating stage	Close	Open
	Program 01 is set as SBU or Solar first	Battery voltage (SOC) > Setting value in Program 13 or battery charging reaches floating stage	Close	Open	

OPERATION

Power ON/OFF

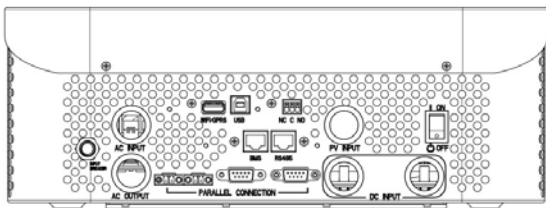

Once the unit has been properly installed and the batteries are connected well, simply press On/Off switch (located on the button of the case) to turn on the unit.

Operation and Display Panel

The operation and display panel, shown in below chart, is on the front panel of the inverter. It includes three indicators, four function keys and a LCD display, indicating the operating status and input/output power information.

- ① LCD display
- ② Status indicator
- ③ Charging indicator
- ④ Fault indicator
- ⑤ Function buttons

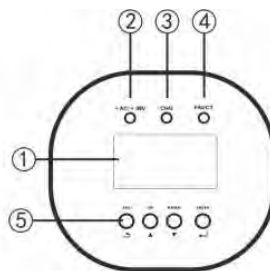

LED Indicator

LED Indicator		Messages	
	Green	Solid On	Output is powered by utility in Line mode.
		Flashing	Output is powered by battery or PV in battery mode.
	Green	Solid On	Battery is fully charged.
		Flashing	Battery is charging.
	Red	Solid On	Fault occurs in the inverter.
		Flashing	Warning condition occurs in the inverter.

Function Buttons

Button	Description
ESC	To exit setting mode
UP	To go to previous selection
DOWN	To go to next selection
ENTER	To confirm the selection in setting mode or enter setting mode

LCD Display Icons

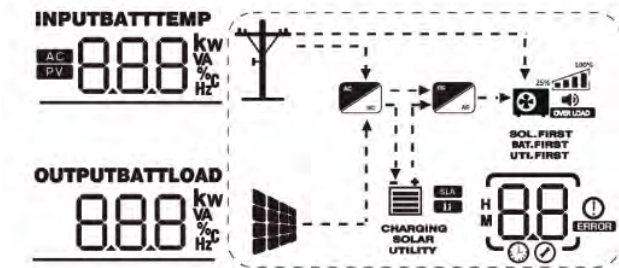

Icon	Function Description
Input Source Information	
	Indicates the AC input.
	Indicates the PV input
	Indicate input voltage, input frequency, PV voltage, battery voltage and charger current.
Configuration Program and Fault Information	
	Indicates the setting programs.
	Warning: flashing with warning code.
	Fault: lighting with fault code
Output Information	
	Indicate output voltage, output frequency, load percent, load in VA, load in Watt and discharging current.
Battery Information	
	Indicates battery level by 0-24%, 25-49%, 50-74% and 75-100% in battery mode and charging status in line mode.
	These two signs indicate the charge priority. "SOLAR" indicates solar first. "UTILITY" indicate utility first. "SOLAR" blinking indicates solar only; "SOLAR" and "UTILITY" both on indicates combined charging.

In AC mode, it will present battery charging status.

Status	Battery voltage	LCD display
Constant current mode/ Constant voltage mode	<2V/cell	4 bars will flash in turns.
	2~2.083V/cell	Bottom bar will be on and the other three bars will flash in turns.
	2.083~2.167V/cell	Bottom two bars will be on and the other two bars will flash in turns.
	>2.167V/cell	Bottom three bars will be on and the top bar will flash.
Floating mode Batteries are fully charged		4 bars will be on.

In battery mode, it will present battery capacity

Load Percentage	Battery Voltage	LCD Display
Load > 50%	< 1.717V/cell	
	1.717V/cell ~ 1.8V/cell	
	1.8 ~ 1.883V/cell	
	> 1.883 V/cell	
50% > Load > 20%	< 1.817V/cell	
	1.817V/cell ~ 1.9V/cell	
	1.9 ~ 1.983V/cell	
	> 1.983	
Load < 20%	< 1.867V/cell	
	1.867V/cell ~ 1.95V/cell	
	1.95 ~ 2.033V/cell	
	> 2.033	

Load Information

	Indicates overload.			
	Indicates the load level by 0-24%, 25-49%, 50-74% and 75-100%.			
	0%~24%	25%~49%	50%~74%	75%~100%

Mode Operation Information

	Indicates unit connects to the mains.
	Indicates unit connects to the PV panel.
	Indicates load is supplied by utility power.
	Indicates the utility charger circuit is working.
	Indicates the DC/AC inverter circuit is working.
	These three signs indicate the output priority. "SOL.FIRST" indicates solar first. "BAT.FIRST" indicates battery first. "UTI.FIRST" indicates utility first.

Mute Operation















	Indicates unit alarm is Enabled.
--	----------------------------------

LCD Setting



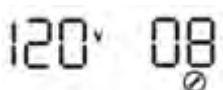
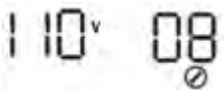
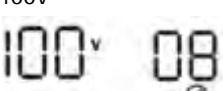

















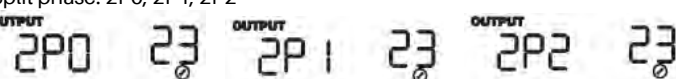

After pressing and holding ENTER button for 3 seconds, it will enter setting mode. Press "UP" or "DOWN" button to select setting programs. Then press "ENTER" button to confirm the selection or ESC button to exit.

Setting Programs:

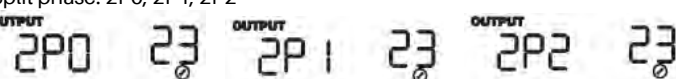
Program	Description	Setting Option	
01	Output source priority: To configure load power source priority	Solar first	SOL 01
		Solar energy provides power to the loads as first priority. If solar energy is not sufficient to power all connected loads, battery energy will supply power the loads at the same time. Utility provides power to the loads only when any one condition happens: - Solar energy is not available - Battery voltage drops to either low-level warning voltage or the setting point in program 12.	
		Utility first (default)	UTI 01
		Utility will provide power to the loads as first priority. Solar and battery energy will provide power to the loads only when utility power is not available.	
02	Maximum charging current: To configure total charging current for solar and utility chargers. (Max. charging current = utility charging current + solar charging current)	SBU priority	SBU 01
		Solar energy provides power to the loads as first priority. If solar energy is not sufficient to power all connected loads, battery energy will supply power to the loads at the same time. Utility provides power to the loads only when battery voltage drops to either low-level warning voltage or the setting point in program 12.	
02		80 ^A	02
		24V model: default 60A, 10A~140A settable 48V model: default 60A, 10A~120A settable (If Li is selected in Program 5, this program can't be set up)	
03	AC input voltage range	APL 03	If selected, acceptable AC input voltage range will be within 65~140VAC
		UPS 03	If selected, acceptable AC input voltage range will be within 95~140VAC
		GEN 03	If selected, acceptable AC input voltage range will be within 65~140VAC. In this mode, the Max. charging current is 30A. Note: When connecting generator, the generator should be no less than 10KVA(no less than 20KVA for three phase parallel system), and the inverters should be no more than 2 units in one phase.
		Appliance (default)	
		Generator (Only diesel generators allowed)	

04	Power saving mode enable/disable	 Saving mode disable [Ⓢ] (default)	If disabled, no matter connected load is low or high, the on/off status of inverter output will not be effected.
		 Saving mode enable	If enabled, the output of inverter will be off when connected load is pretty low or not detected.
05	Battery type	AGM (default) 	User-Defined  If "User-Defined" is selected, battery charge voltage and low DC cut-off voltage can be set up in program 19, 20 and 21.
		Flooded 	
		Lithium  (Only suitable when communicated with BMS)	
		User-Defined 2 (suitable when lithium battery without BMS communication)  If "User-Defined 2" is selected, battery charge voltage and low DC cut-off voltage can be set up in program 19, 20 and 21. It is recommended to set to the same voltage in program 19 and 20(full charging voltage point of lithium battery). The inverter will stop charging when the battery voltage reaches this setting.	
06	Auto restart when overload occurs	Restart disable (default) 	Restart enable 
		Restart disable (default) 	Restart enable 
08	Output voltage	120V (default) 	110V 
		100V 	
09	Output frequency	50Hz 	60Hz (default) 
		 (e.g. Showing batteries are connected in 4 series)	

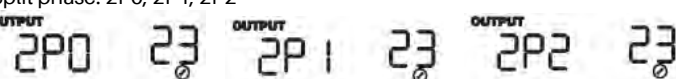
11	Maximum utility charging current Note: If setting value in Program 02 is smaller than that in Program 11, the inverter will apply charging current from Program 02 for utility charger	30 [^] 11 24V model: default 30A, 0A~60A Settable 48V model: default 30A, 0A~40A Settable (If Li is selected in Program 5, this program can't be set up)
12	Setting voltage point back to utility source when selecting "SBU priority" or "Solar first" in program 01	46.0 ^v 12 24V model: default 23.0V, 22.0V~25.6V Settable 48V model: default 46.0V, 44.0V~51.2V Settable
13	Setting voltage point back to battery mode when selecting "SBU priority" or "Solar first" in program 01	54.0 ^v 13 24V model: default 27.0V, 24.0V~29.0V Settable 48V model: default 54.0V, 48.0V~58.0V Settable
14	Charger source priority: To configure charger source priority	If this off grid solar inverter is working in Line, Standby or Fault mode, charger source can be programmed as below:
		Solar first CS0 14 Solar energy will charge battery as first priority. Utility will charge battery only when solar energy is not available.
		Utility first CUE 14 Utility will charge battery as first priority. Solar energy will charge battery only when utility power is not available.
		Solar and Utility SNU 14 Solar energy and utility will both charge battery.
		Only Solar OSO 14 Solar energy will be the only charger source no matter utility is available or not.
		If this off grid solar inverter is working in Battery mode or Power saving mode, only solar energy can charge battery. Solar energy will charge battery if it's available and sufficient.
15	Alarm control	Alarm on (default) 60N 15 Alarm off 60F 15
16	Backlight control	Backlight on (default) LON 16 Backlight off LOF 16
17	Beeps while primary source is interrupted	Alarm on (default) RON 17 Alarm off ROF 17
18	Overload bypass: When enabled, the unit will transfer to line mode if overload occurs in battery mode.	Bypass disable (default) byd 18
		Bypass enable byE 18

19	C.V. charging voltage. If self-defined is selected In program 5, this program can be set up	 <p>24V model: default 28.2V, 24.0V~29.2V Settable 48V model: default 56.4V, 48.0V~58.4V Settable</p>								
20	Floating charging voltage. If self-defined is selected in program 5, this program can be set up	 <p>24V model: default 27.0V, 24.0V~29.2V Settable 48V model: default 54.0V, 48.0V~58.4V Settable</p>								
21	Low DC cut-off voltage. 1. If battery power is only power source available, inverter will shut down. 2. If PV energy and battery power are available, inverter will charge battery without AC output. 3. If PV energy, battery power and utility are all available, inverter will transfer to line mode and provide output power to loads, and charge the battery at the same time.	 <p>24V model: default 21.0V, 20.0V~24.0V Settable 48V model: default 42.0V, 40.0V~48.0V Settable</p> <p>If self-defined is selected in program 5, this program can be set up. Low DC cut-off voltage will be fixed to setting value no matter what percentage of load is connected.</p>								
22	Solar power balance. When enabled, solar input power will be automatically adjusted according to connected load power.	<table border="1" style="width: 100%; border-collapse: collapse;"> <tr> <td style="width: 50%; padding: 5px;"> Solar power balance enable (Default):  </td> <td style="width: 50%; padding: 5px;"> If selected, solar input power will be automatically adjusted according to the following formula: Max. input solar power = Max. battery charging power + Connected load power. </td> </tr> <tr> <td style="padding: 5px;"> Solar power balance disable  </td> <td style="padding: 5px;"> If selected, the solar input power will be the same to max. battery charging power no matter how much loads are connected. The max. battery charging power will be based on the setting current in program 2. (Max. solar power = Max. battery charging power) </td> </tr> </table>	Solar power balance enable (Default): 	If selected, solar input power will be automatically adjusted according to the following formula: Max. input solar power = Max. battery charging power + Connected load power.	Solar power balance disable 	If selected, the solar input power will be the same to max. battery charging power no matter how much loads are connected. The max. battery charging power will be based on the setting current in program 2. (Max. solar power = Max. battery charging power)				
Solar power balance enable (Default): 	If selected, solar input power will be automatically adjusted according to the following formula: Max. input solar power = Max. battery charging power + Connected load power.									
Solar power balance disable 	If selected, the solar input power will be the same to max. battery charging power no matter how much loads are connected. The max. battery charging power will be based on the setting current in program 2. (Max. solar power = Max. battery charging power)									
23	AC output mode *This setting is only available when the inverter is in standby mode (Switch off). Power saving function will be automatically disabled when in parallel operation.	<table border="1" style="width: 100%; border-collapse: collapse;"> <tr> <td style="width: 60%; padding: 5px;"> Single mode  </td> <td style="width: 40%; padding: 5px;">When not in parallel operation</td> </tr> <tr> <td style="padding: 5px;"> Single phase  </td> <td style="padding: 5px;">When the units are used in parallel with single phase</td> </tr> <tr> <td style="padding: 5px;"> Three phase: 3P1, 3P2, 3P3  </td> <td style="padding: 5px;"> It requires at least 3 inverters to support three-phase equipment, 1 inverter in each phase. Please select "3P1" for the inverters connected to L1 phase, "3P2" for the inverters connected to L2 phase and "3P3" for the inverters connected to L3 phase. Do NOT connect share current cable between units on different phases. </td> </tr> <tr> <td style="padding: 5px;"> Split phase: 2P0, 2P1, 2P2  </td> <td style="padding: 5px;"> Select "2P0" for the inverters connected to L1 phase; If connect split phase 120V/208V, select "2P1" for inverters connected to L2 phase; If connect split phase 120V/240V, select "2P2" for inverters connected to L2 phase Do NOT connect share current cable between units on different phases. </td> </tr> </table>	Single mode 	When not in parallel operation	Single phase 	When the units are used in parallel with single phase	Three phase: 3P1, 3P2, 3P3 	It requires at least 3 inverters to support three-phase equipment, 1 inverter in each phase. Please select "3P1" for the inverters connected to L1 phase, "3P2" for the inverters connected to L2 phase and "3P3" for the inverters connected to L3 phase. Do NOT connect share current cable between units on different phases.	Split phase: 2P0, 2P1, 2P2 	Select "2P0" for the inverters connected to L1 phase; If connect split phase 120V/208V, select "2P1" for inverters connected to L2 phase; If connect split phase 120V/240V, select "2P2" for inverters connected to L2 phase Do NOT connect share current cable between units on different phases.
Single mode 	When not in parallel operation									
Single phase 	When the units are used in parallel with single phase									
Three phase: 3P1, 3P2, 3P3 	It requires at least 3 inverters to support three-phase equipment, 1 inverter in each phase. Please select "3P1" for the inverters connected to L1 phase, "3P2" for the inverters connected to L2 phase and "3P3" for the inverters connected to L3 phase. Do NOT connect share current cable between units on different phases.									
Split phase: 2P0, 2P1, 2P2 	Select "2P0" for the inverters connected to L1 phase; If connect split phase 120V/208V, select "2P1" for inverters connected to L2 phase; If connect split phase 120V/240V, select "2P2" for inverters connected to L2 phase Do NOT connect share current cable between units on different phases.									
28	Address setting	 <p>24V model: default 1, 1~255 Settable 48V model: default 1, 1~255 Settable</p>								

43	Battery equalization	Battery equalization enable E9	Battery equalization disable(default) E9
		E9A 43	d15 43
If "Flooded" or "User-Defined" is selected in program 05, this program can be set up.			
44	Battery equalization Voltage	E9V	
		58.4V 44	
24V model: default 29.2V, 24.0V~29.2V Settable 48V model: default 58.4V, 48.0V~58.4V Settable			
45	Battery equalized time	E9t	
		60 45	
46	Battery equalized timeout	E90	
		120 46	
47	Equalization interval	E9i	
		30 47	
48	Equalization activated immediately	Equalization activated immediately on E9	Equalization activated immediately off(default) E9
		tOn 48	tOf 48
If equalization function is enabled in program 43, this program can be setup. If "On" is selected in this program, it's to activate battery equalization immediately and LCD main page will shows "E9". If "Off" is selected, it will cancel equalization function until next activated equalization time arrives based on program 47setting. At this time, "E9" will not be shown in LCD main page.			

Display Setting

The LCD display information will be switched in turns by pressing "UP" or "DOWN" key. The selectable information is switched as below order: input voltage, input frequency, PV voltage, MPPT charging current, MPPT charging power, battery voltage, output voltage, output frequency, load percentage, load in VA, load in Watt, DC discharging current, main CPU Version and second CPU Version.

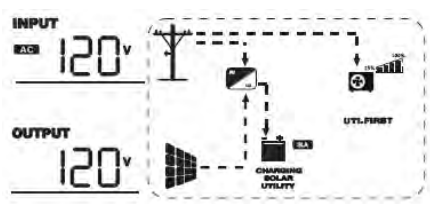

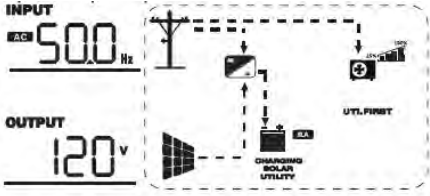
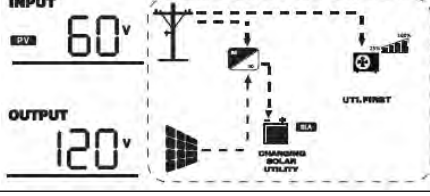
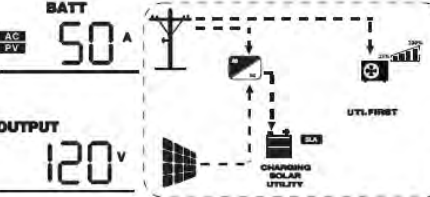
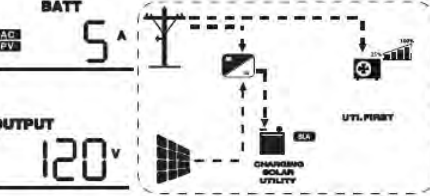
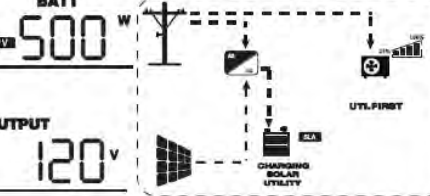
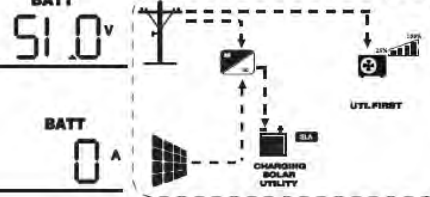
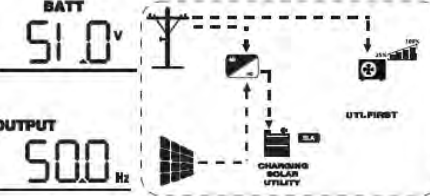

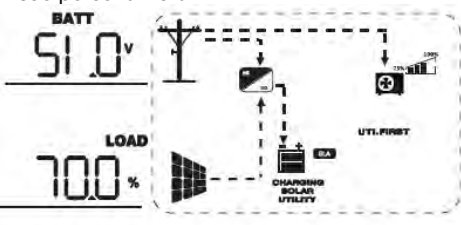
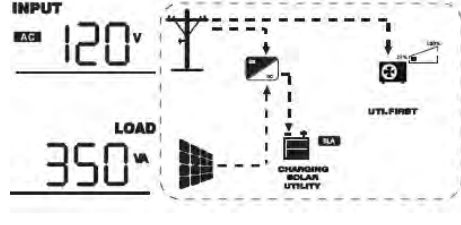
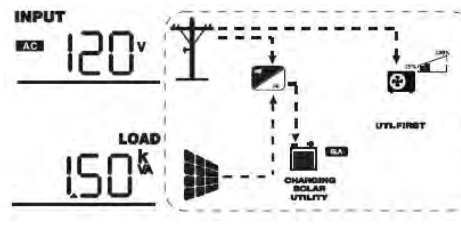
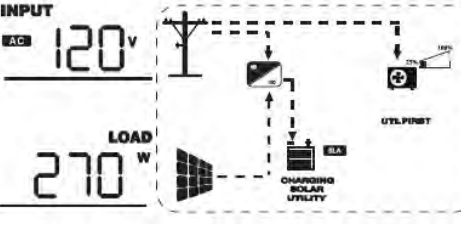
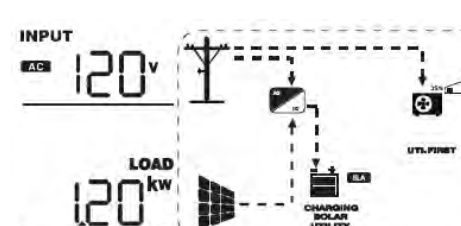
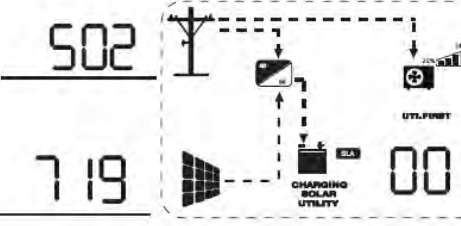
Setting Information	LCD display
Input voltage/Output voltage (Default Display Screen)	Input Voltage= 120V, output voltage=120V 

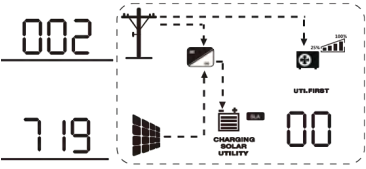
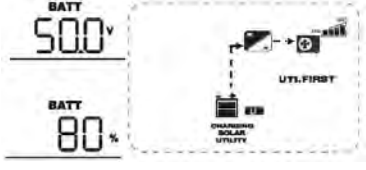
Input frequency	<p>Input frequency=50Hz</p> 
PV voltage	<p>PV voltage=60V</p> 
Charging current	<p>Current $\geq 10A$</p>  <p>Current < 10A</p> 
MPPT Charging power	<p>MPPT charging power=500W</p> 
Battery voltage/ DC discharging current	<p>Battery voltage=51.0V, discharging current=0A</p> 
Output frequency	<p>Output frequency=50Hz</p> 

<p>Load percentage</p>	<p>Load percent=70%</p> 
<p>Load in VA</p>	<p>When connected load is lower than 1kVA, load in VA will present xxx VA like below chart.</p>  <p>When load is larger than 1kVA ($\geq 1kVA$), load in VA will present x.x kVA like below chart.</p> 
<p>Load in Watt</p>	<p>When load is lower than 1kW, load in W will present xxx W like below chart.</p>  <p>When load is larger than 1kW ($\geq 1kW$), load in W will present x.x kW like below chart.</p> 
<p>Main CPU version checking</p>	<p>Main CPU version 502-00-719</p> 

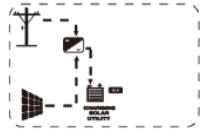
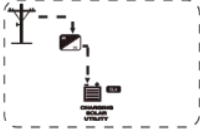
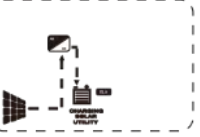
Secondary CPU version checking	Secondary CPU version 002-00-719 
Battery SOC	Battery SOC=80% 

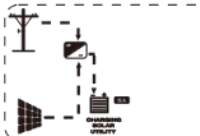
Operating Mode Description

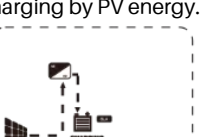
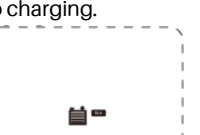
Operation mode	Description	LCD display
Standby mode / Power saving mode Note: *Standby mode: The inverter is not turned on yet but at this time, the inverter can charge battery without AC output. *Power saving mode: If enabled, the output of inverter will be off when connected load is pretty low or not detected.	No output is supplied by the unit but it still can charge batteries.	Charging by utility and PV energy.  Charging by utility.  Charging by PV energy.  No charging. 
Fault mode Note: *Fault mode: Errors are caused by inside circuit error or external reasons such as over temperature, output short circuited and so on.	PV energy and utility can charge batteries.	Charging by utility and PV energy.  Charging by utility.  Charging by PV energy.  No charging. 

PARALLEL INSTALLATION GUIDE

Introduction

This inverter can be used in parallel with three different operation modes.

1. Parallel operation in single phase with up to 6 units.
2. Maximum 6 units work together to support three-phase equipment. Four units support one phase maximum.
3. Maximum 6 units work together to support split-phase equipment. Five units support one phase maximum.

Note: If the package includes share current cable and parallel cable, the inverter is default supported parallel operation. You may skip section 3. If not, please purchase parallel kit and install this unit by following instruction from professional technical personnel in local dealer.

Package Contents

In parallel kit, you will find the following items in the package:

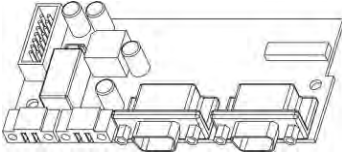

Parallel board



Parallel communication cable



Current sharing cable

Parallel Board Installation

Step 1: Remove wire cover by unscrewing all screws

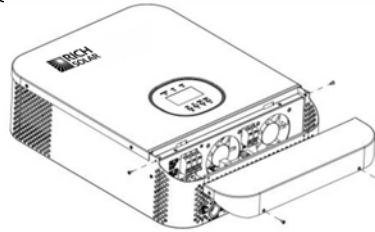

Step 2: Remove communication board by unscrewing two screws as below chart.

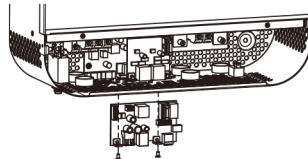

Step 3: Remove Rs485 communication board by unscrewing two screws as below chart.(BMS model)

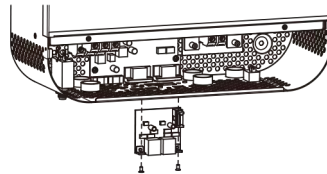

Step 4: Remove two screws as below chart and remove 2-pin and 14-pin cables. Take out the board under the communication board.

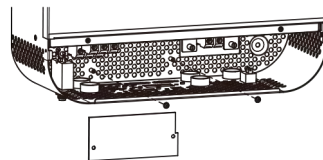

Step 5: Remove two screws as below chart to take out cover of parallel communication.

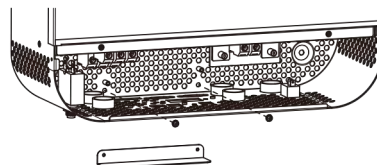

Step 6: Install new parallel board with 2 screws tightly.

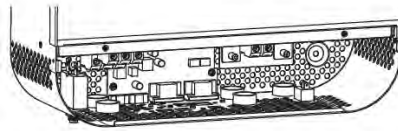

Step 7: Re-connect 2-pin and 14-pin to original position.

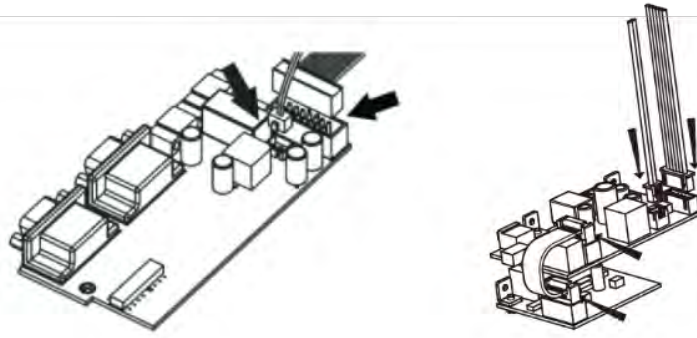

Parallel board

Communication board

Step 8: Put communication board back to the unit.

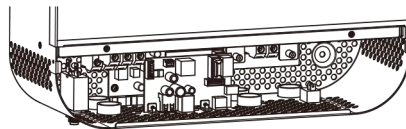

Step 9: Put wire cover back to the unit. Now the inverter is providing parallel operation function.

Mounting the Unit

When installing multiple units, please follow below chart.

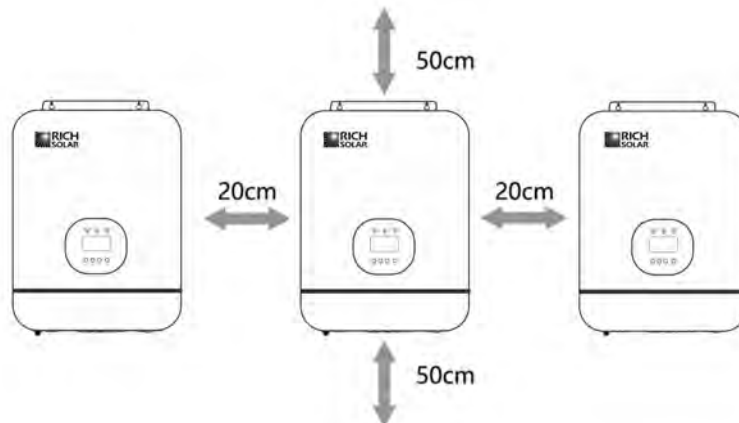

Note: For proper air circulation to dissipate heat, allow a clearance of approx. 20cm to the side and approx. 50 cm above and below the unit. Be sure to install each unit in the same level.

Wiring Connection

The cable size of each inverter is shown as below:

Recommended battery cable and terminal size for each inverter:

Model	Wire Size	Ring Terminal			Torque value
		Cable mm ²	Dimensions		
			D(mm)	L(mm)	
RS-H3000-24	1*2AWG	38	6.4	39.2	2~3 Nm
	2*6AWG	28	6.4	39.2	
RS-H3000-48	1*4AWG	22	6.4	39.2	2~3 Nm
	2*8AWG	16	6.4	39.2	

Ring terminal:

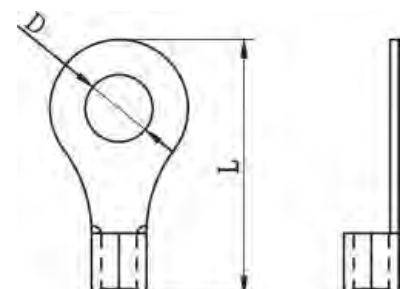

WARNING: Be sure the length of all battery cables is the same. Otherwise, there will be voltage difference between inverter and battery to cause parallel inverters not working.

Recommended AC input and output cable size for each inverter:

Model	AWG no.	Torque
RS-H3000	8 AWG	1.4~1.6Nm

You need to connect the cables of each inverter together. Take the battery cables for example: You need to use a connector or bus-bar as a joint to connect the battery cables together, and then connect to the battery terminal. The cable size used from joint to battery should be X times cable size in the tables above. "X" indicates the number of inverters connected in parallel.

Regarding AC input and output, please also follow the same principle.

CAUTION!! Please install the breaker at the battery and AC input side. This will ensure the inverter can be securely disconnected during maintenance and fully protected from over current of battery or AC input.

Recommended breaker specification of battery for each inverter:

Model	1 unit
RS-H3000-24	150A/32VDC
RS-H3000-48	100A/60VDC

*If you want to use only one breaker at the battery side for the whole system, the rating of the breaker should be X times current of 1 unit. "X" indicates the number of inverters connected in parallel.

Recommended breaker specification of AC input with single phase:

Model	2 units	3 units	4 units	5 units	6 units
RS-H3000	100A/120VAC	150A/120VAC	200A/120VAC	250A/120VAC	300A/120VAC

Note1: Also, you can use 50A breaker for only 1 unit, and each inverter has a breaker at its AC input.

Note2: Regarding three phase system, you can use 4 poles breaker, the rating is up to the current of the phase which has the maximum units. Or you can follow the suggestion of note 1.

Recommended battery capacity

Inverter parallel numbers	2	3	4	5	6
Battery Capacity	400AH	600AH	800AH	1000AH	1200AH

WARNING! Be sure that all inverters will share the same battery bank. Otherwise, the inverters will transfer to fault mode.

Parallel Operation in Single phase

Two inverters in parallel:

Power Connection

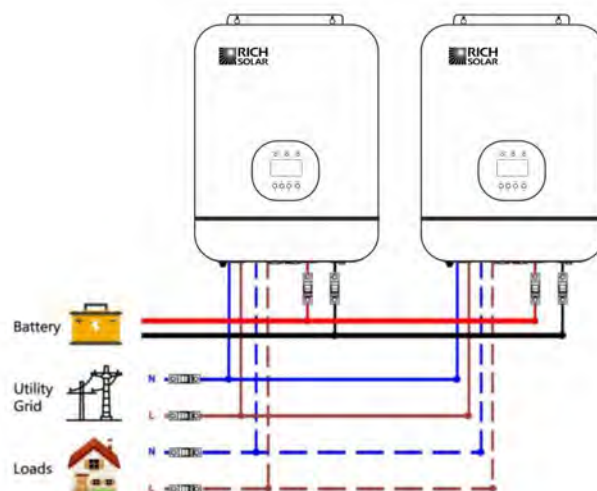

Communication Connection

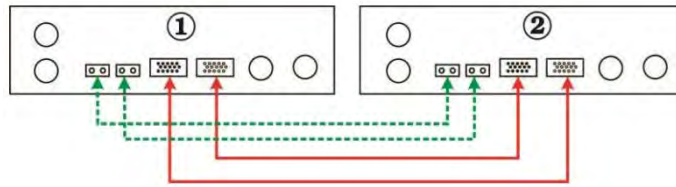

Three inverters in parallel:

Power Connection

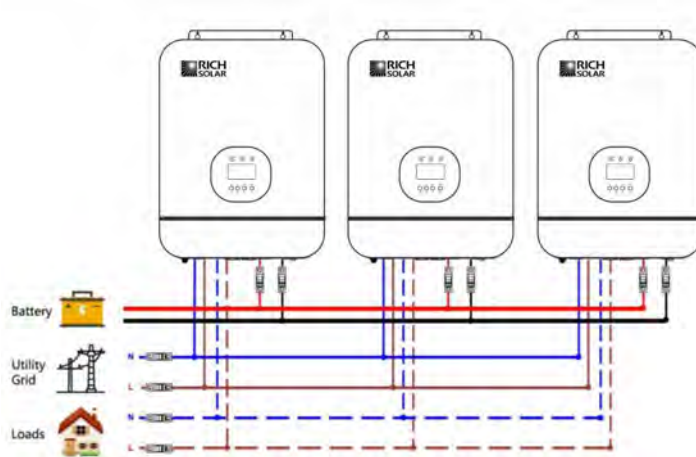

Communication Connection

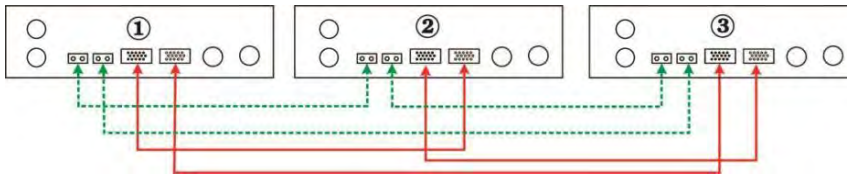

Four inverters in parallel:

Power Connection

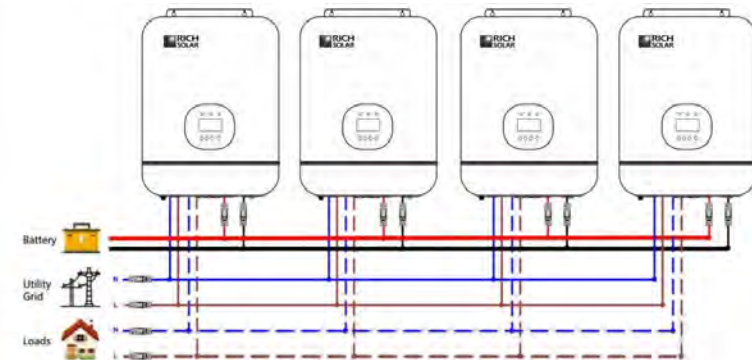

Communication Connection

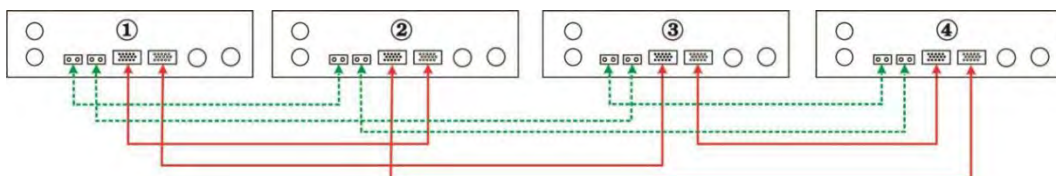

Five inverters in parallel:

Power Connection

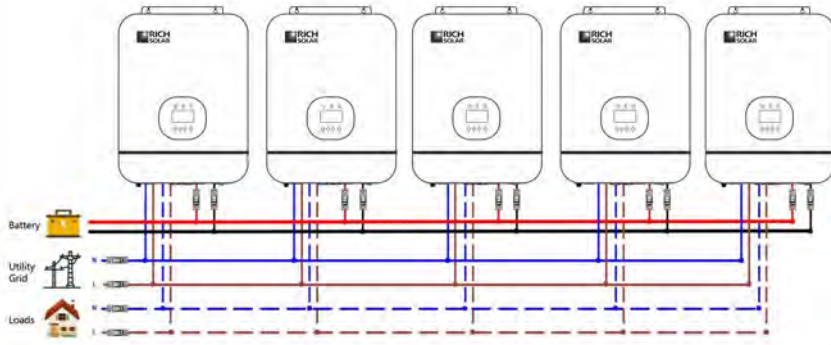

Communication Connection

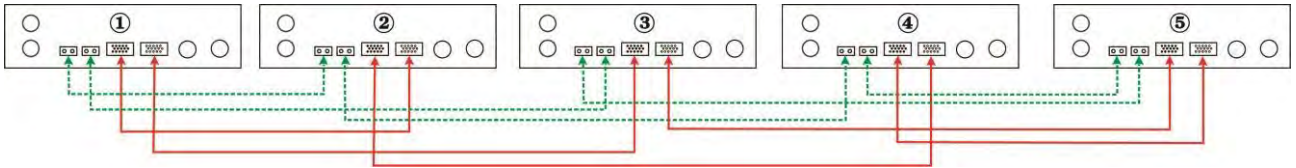

Six inverters in parallel:

Power Connection

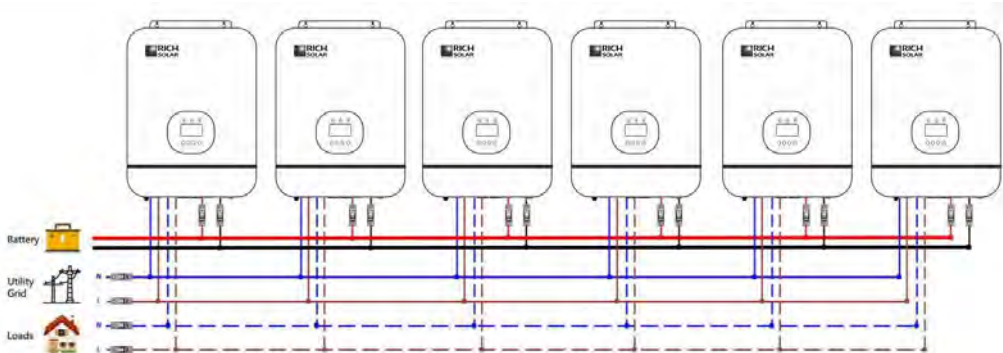

Communication Connection

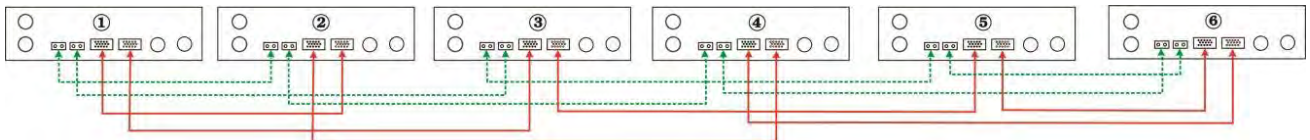

Parallel Operation in Three Phase

One inverter in each phase:

Power Connection

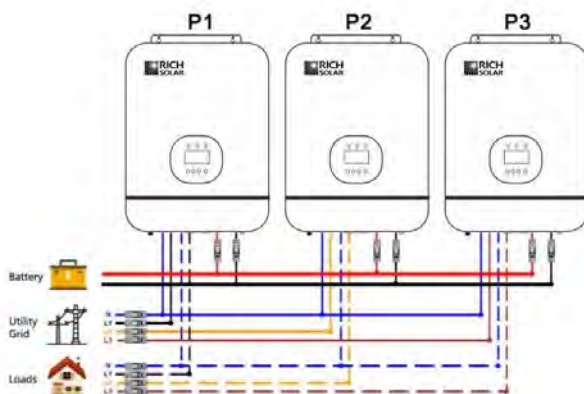

Communication Connection

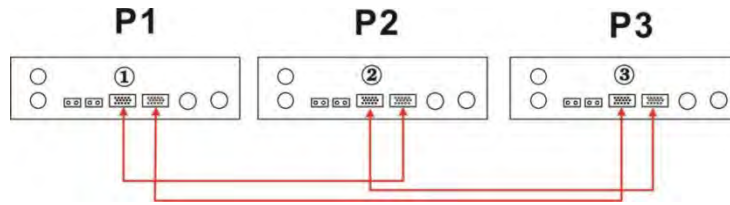

Two inverters in one phase and only one inverter for the remaining phases:

Power Connection

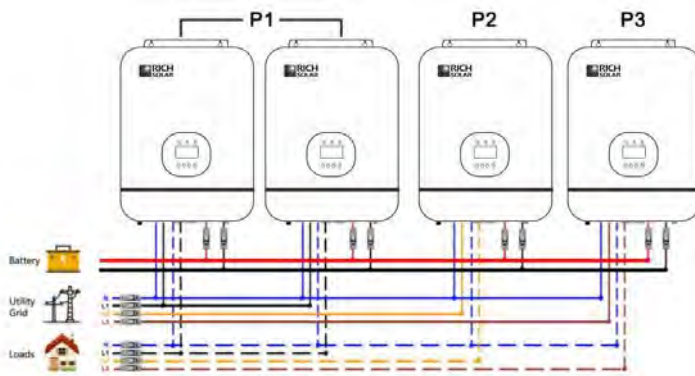

Communication Connection

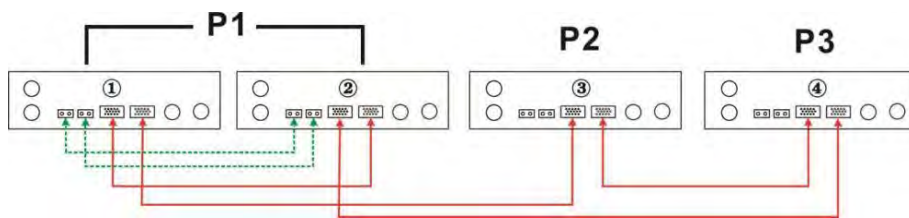

Two inverters in two phases and only one inverter for the remaining phase:

Power Connection

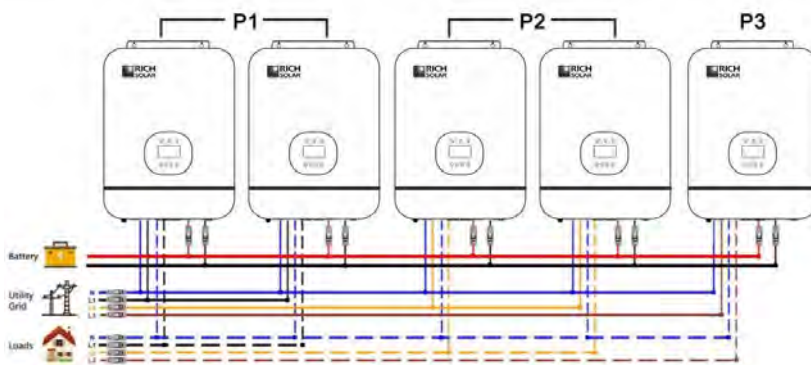

Communication Connection

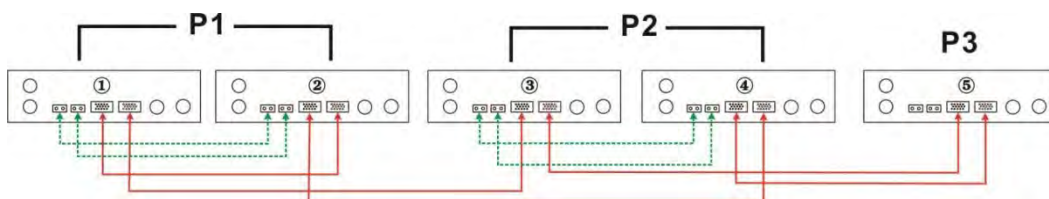

Three inverters in one phase and only one inverter for the remaining two phases:

Power Connection

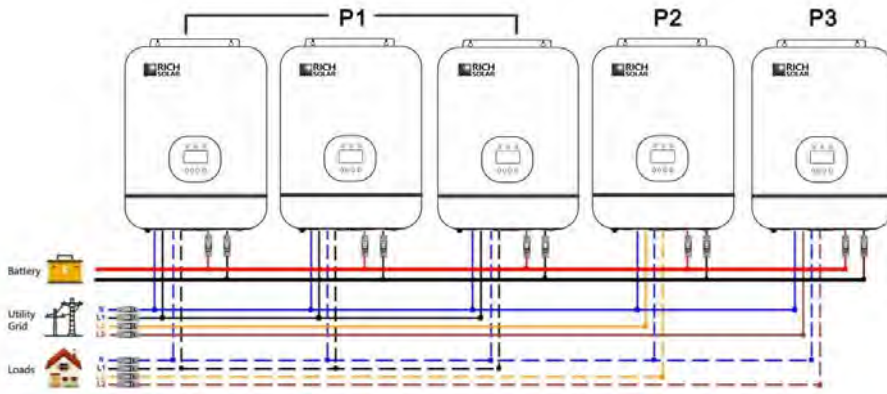

Communication Connection

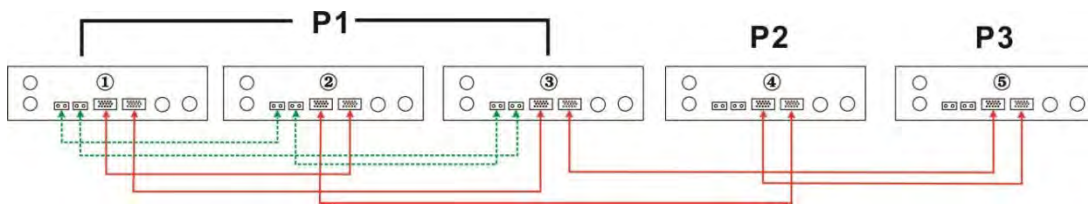

Two inverters in each phase:

Power Connection

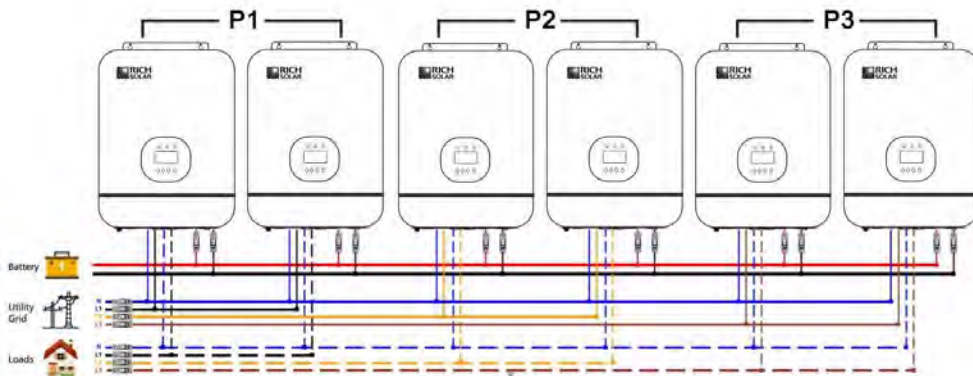

Communication Connection

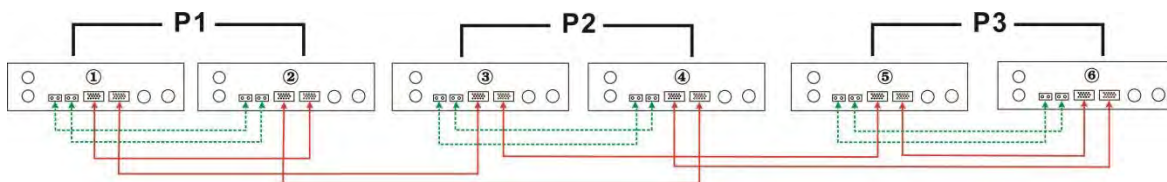

Three inverters in one phase, two inverters in second phase and one inverter for the third phase:

Power Connection

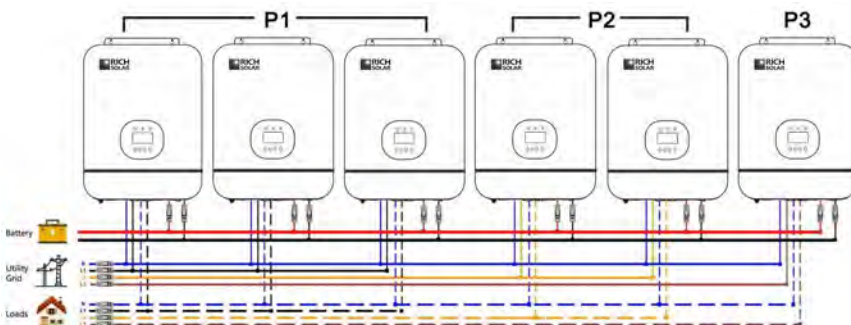

Communication Connection

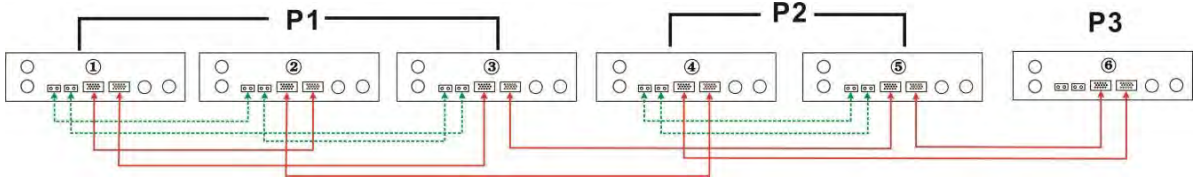

Four inverters in one phase and one inverter for the other two phases:

Power Connection

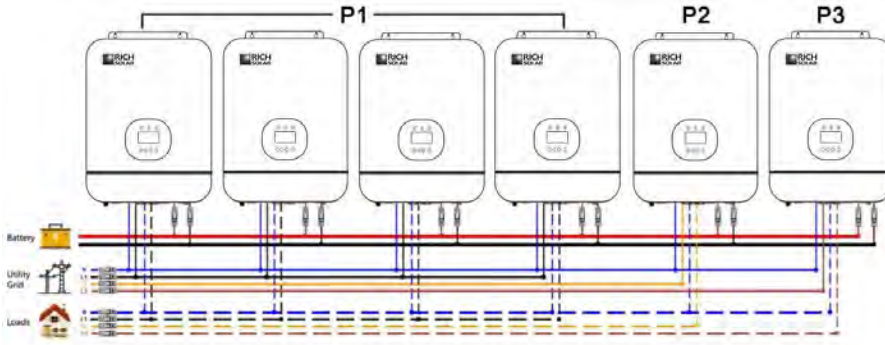

Communication Connection

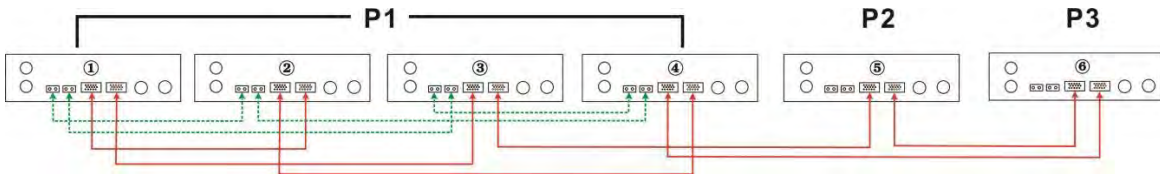

WARNING: Do not connect the current sharing cable between the inverters which are in different phases. Otherwise, it may damage the inverters.

Parallel Operation in Split Phase

One inverter in each phase:

Power Connection

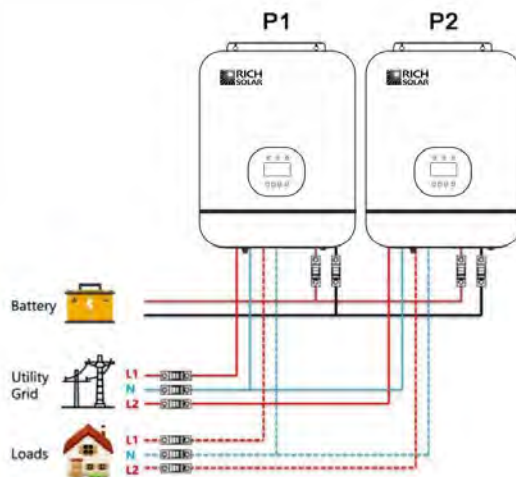

Communication Connection

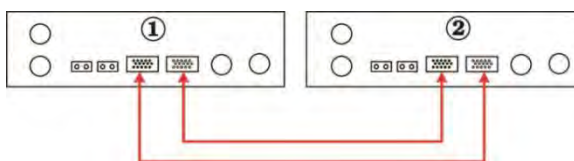

Two inverters in each phase:

Power Connection

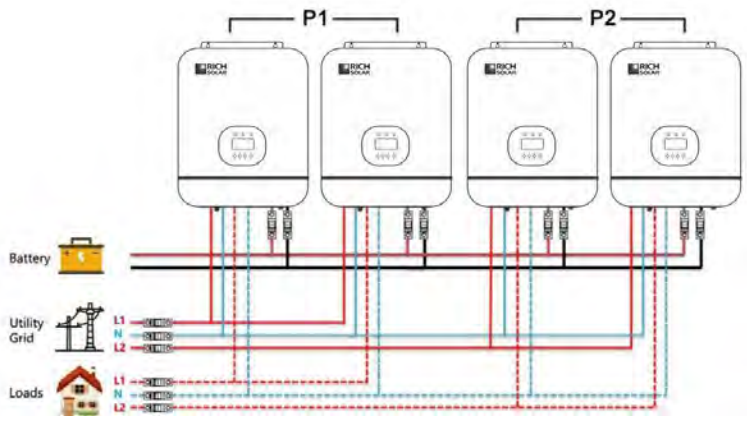

Communication Connection

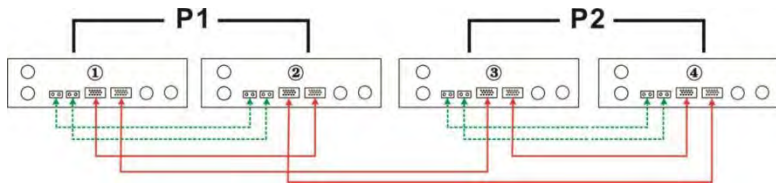

Three inverters in each phase:

Power Connection

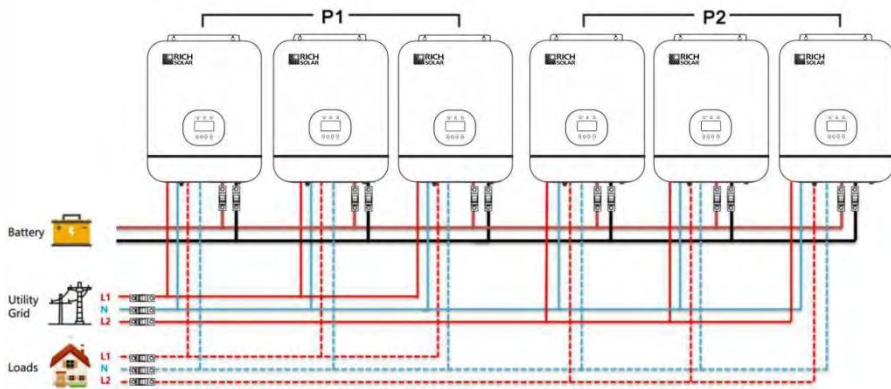

Communication Connection

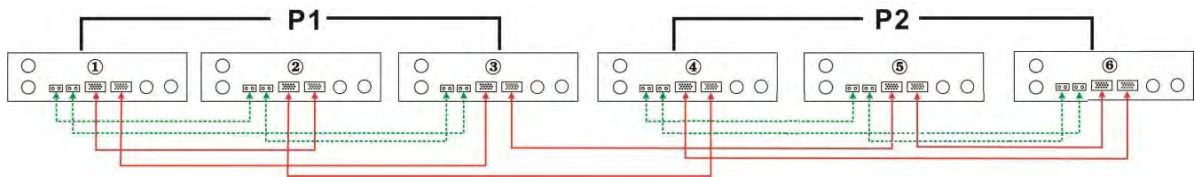

WARNING: Do not connect the current sharing cable between the inverters which are in different phases. Otherwise, it may damage the inverters.

PV Connection

Please refer to user manual of single unit for PV Connection.

CAUTION: Each inverter should connect to PV modules separate

LCD Setting and Display

Setting Program: Please refer to Program 23

Commissioning

Parallel in single phase

Step 1: Check the following requirements before commissioning:

- ⌘ Correct wire connection
- ⌘ Ensure all breakers in Line wires of load side are open and each Neutral wires of each unit are connected together.

Step 2: Turn on each unit and set "PAL" in LCD setting program 23 of each unit. And then shut down all units.

Note: It's necessary to turn off switch when setting LCD program. Otherwise, the setting can not be programmed.
 Step 3: Turn on each unit.

LCD display in Master unit	LCD display in Slave unit

Note: Master and slave units are randomly defined.

Step 4: Switch on all AC breakers of Line wires in AC input. It's better to have all inverters connect to utility at the same time. If not, it will display warning 15.

LCD display in Master unit	LCD display in Slave unit

Step 5: If there is no more fault alarm, the parallel system is completely installed.

Step 6: Please switch on all breakers of Line wires in load side. This system will start to provide power to the load.

Parallel in three phase

Step 1: Check the following requirements before commissioning:

- ⌘ Correct wire connection
- ⌘ Ensure all breakers in Line wires of load side are open and each Neutral wires of each unit are connected together.

Step 2: Turn on all units and configure LCD program 23 as 3P1, 3P2 and 3P3 sequentially. Then shut down all units.

Note: It's necessary to turn off switch when setting LCD program. Otherwise, the setting can not be programmed.

Step 3: Turn on all units sequentially. Please turn on HOST inverter first, then turn on the rest one by one.

LCD display in L1-phase unit	LCD display in L2-phase unit	LCD display in L3-phase unit

Step 4: Switch on all AC breakers of Line wires in AC input. If AC connection is detected and three phases are matched with unit setting, they will work normally. Otherwise, they will display warning 15/16 and will not work in the line mode.

LCD display in L1-phase unit	LCD display in L2-phase unit	LCD display in L3-phase unit

Step 5: If there is no more fault alarm, the system to support 3-phase equipment is completely installed.

Step 6: Please switch on all breakers of Line wires in load side. This system will start to provide power to the load.

Note 1: If there's only one inverter in L1-phase, the LCD will show as "HS". If there is more than one inverter in L1-phase, the LCD of the HOST inverter will show as "HS", the rest of L1-phase inverters will show as "P1".

Note 2: To avoid overload occurring, before turning on breakers in load side, it's better to have whole system in operation first.

Note 3: Transfer time for this operation exists. Power interruption may happen to critical devices, which cannot bear transfer time.

Parallel in split phase

Step 1: Check the following requirements before commissioning:

- ⌘ Correct wire connection
- ⌘ Ensure all breakers in Line wires of load side are open and each Neutral wires of each unit are connected together.

Step 2: Turn on all units and configure LCD program 23 as 2P0 on phase1 units, then set as 2P2 (or 2P1) on phase2 units.

2P0 + 2P1: split phase 120V/208V

2P0 + 2P2: split phase 120V/240V

Note: It's necessary to turn off switch when setting LCD program. Otherwise, the setting can not be programmed.

Step 3: Turn on all units sequentially. Please turn on HOST inverter first, then turn on the rest one by one.

LCD display in L1-phase unit	LCD display in L2-phase unit

Step 4: Switch on all AC breakers of Line wires in AC input. If AC connection is detected and split phases are matched with unit setting, they will work normally. Otherwise, they will display warning 15/16 and will not work in the line mode.

LCD display in L1-phase unit	LCD display in L2-phase unit

Step 5: If there is no more fault alarm, the system to support split-phase equipment is completely installed.

Step 6: Please switch on all breakers of Line wires in load side. This system will start to provide power to the load.







Note 1: If there's only one inverter in L1-phase, the LCD will show as "HS". If there is more than one inverter in L1-phase, the LCD of the HOST inverter will show as "HS", the rest of L1-phase inverters will show as "P1".

Note 2: To avoid overload occurring, before turning on breakers in load side, it's better to have whole system in operation first.

Note 3: Transfer time for this operation exists. Power interruption may happen to critical devices, which cannot bear transfer time.

FAULT REFERENCE CODE

Fault Code	Fault Event	Icon on
01	Fan is locked	
02	Over temperature	
03	Battery voltage is too high	
04	Battery voltage is too low	
05	Output short circuited is detected by internal converter components	
06	Output voltage is too high.	
07	Overload time out	
08	Bus voltage is too high	
09	Bus soft start failed	
51	Over current or surge	
52	Bus voltage is too low	
53	Inverter soft start failed	
55	Over DC voltage in AC output	

56	Battery connection is open	
57	Current sensor failed	
58	Output voltage is too low	
60	Negative power fault	
80	CAN fault	
81	Host loss	

WARNING INDICATOR

Warning Code	Warning Event	Audible Alarm	Icon flashing
01	Fan is locked when inverter is on.	Beep three times every second	
02	Over temperature	Beep once every second	
03	Battery is over-charged	Beep once every second	
04	Low battery	Beep once every second	
07	Overload	Beep once every 0.5 second	
10	Output power derating	Beep twice every 3 seconds	
12	Solar charger stops due to low battery	Beep once every second	
13	Solar charger stops due to high PV voltage	Beep once every second	
14	Solar charger stops due to overload	Beep once every second	
15	Parallel input utility grid different	Beep once every second	
16	Parallel input phase error	Beep once every second	
17	Parallel output phase loss	Beep once every second	
20	BMS communication error	Beep once every second	
33	BMS communication loss	Beep once every second	
34	Cell over voltage	Beep once every second	
35	Cell under voltage	Beep once every second	
36	Total over voltage	Beep once every second	
37	Total under voltage	Beep once every second	
38	Discharge over current	Beep once every second	
39	Charge over current	Beep once every second	

40	Discharge over temperature	Beep once every second	[40°]
41	Charge over temperature	Beep once every second	[41°]
42	Mosfet over temperature	Beep once every second	[42°]
43	Battery over temperature	Beep once every second	[43°]
44	Battery under temperature	Beep once every second	[44°]
45	System shut down	Beep once every second	[45°]

BATTERY EQUALIZATION

Equalization function is added into charge controller. It reverses the buildup of negative chemical effects like stratification, a condition where acid concentration is greater at the bottom of the battery than at the top. Equalization also helps to remove sulfate crystals that might have built up on the plates. If left unchecked, this condition, called sulfation, will reduce the overall capacity of the battery. Therefore, it's recommended to equalize battery periodically.

How to Apply Equalization Function

You must enable battery equalization function in monitoring LCD setting program 43 first. Then, you may apply this function in device by either one of following methods:

1. Setting equalization interval in program 47.
2. Active equalization immediately in program 48.

When to Equalize

In float stage, when the setting equalization interval (battery equalization cycle) is arrived, or equalization is active immediately, the controller will start to enter Equalize stage.

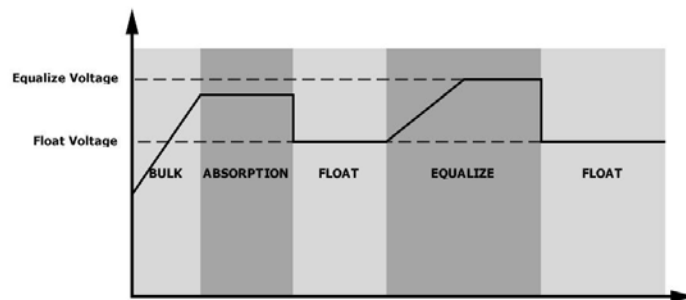

Equalize charging time and timeout

In Equalize stage, the controller will supply power to charge battery as much as possible until battery voltage raises to battery equalization voltage. Then, constant-voltage regulation is applied to maintain battery voltage at the battery equalization voltage. The battery will remain in the Equalize stage until setting battery equalized time is arrived.

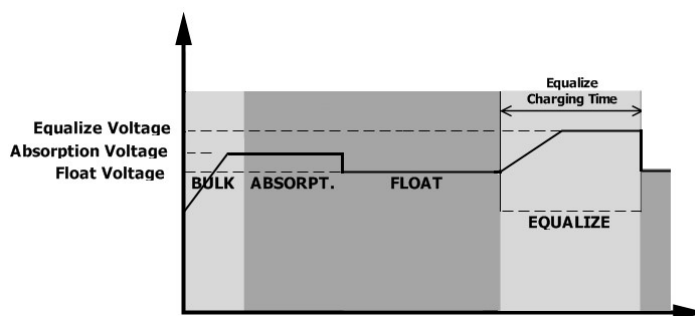

However, in Equalize stage, when battery equalized time is expired and battery voltage doesn't rise to battery equalization voltage point, the charge controller will extend the battery equalized time until battery voltage achieves battery equalization voltage. If battery voltage is still lower than battery equalization voltage when battery equalized timeout setting is over, the charge controller will stop equalization and return to float stage.

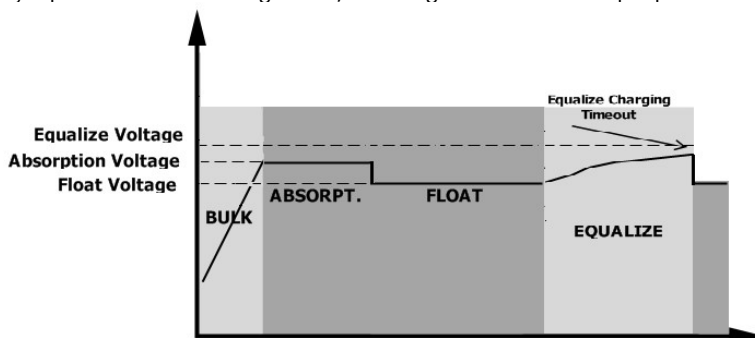

SPECIFICATIONS

Table 1 General Specifications

INVERTER MODEL	RS-H3000
Safety Certification	CE
Operating Temperature Range	0°C ~ 55°C
Storage temperature	-15°C ~ 60°C
Humidity	5% to 95% Relative Humidity (Non-condensing)
Dimension, mm	455 x 350 x 130
Net Weight, kg	11.5
Altitude	<2000m

Table 2 Line Mode Specifications

INVERTER MODEL	RS-H3000
Input Voltage Waveform	Sinusoidal (utility or generator)
Nominal Input Voltage	120Vac
Low Loss Voltage	95Vac±5V (UPS); 65Vac±5V (Appliances)
Low Loss Return Voltage	100Vac±5V (UPS); 70Vac±5V (Appliances)
High Loss Voltage	140Vac±5V
High Loss Return Voltage	135Vac±5V
Max AC Input Voltage	150Vac
Nominal Input Frequency	50Hz / 60Hz (Auto detection)
Low Loss Frequency	40±1Hz
Low Loss Return Frequency	42±1Hz
High Loss Frequency	65±1Hz
High Loss Return Frequency	63±1Hz
Output Short Circuit Protection	Circuit Breaker
Efficiency (Line Mode)	>95% (Rated R load, battery full charged)
Transfer Time	10ms typical, 20ms Max@ Single <30ms @ Parallel
<p>Output power derating: When AC input voltage drops to 95V, the output power will be derated.</p>	

Table 3 Inverter Mode Specifications

INVERTER MODEL	RS-H3000-24	RS-H3000-48
Rated Output Power	3KVA/3KW	
Output Voltage Waveform	Pure Sine Wave	
Output Voltage Regulation	120Vac ±5%	
Output Frequency	50Hz/60Hz(default)	
Peak Efficiency	90%	
Overload Protection	5s@≥150% load; 10s@110%~150% load	
Surge Capacity	2* rated power for 5 seconds	
Nominal DC Input Voltage	24Vdc	48Vdc
Cold Start Voltage (Lead-Acid Mode)	23.0Vdc	46.0Vdc
Cold Start SOC (Li Mode)	Default 30%, Low DC Cut-off SOC +10%	
Low DC Warning Voltage (Lead-Acid Mode)	22.0Vdc @ load < 20% 21.4Vdc @ 20% ≤ load < 50% 20.2Vdc @ load ≥ 50%	44.0Vdc @ load < 20% 42.8Vdc @ 20% ≤ load < 50% 40.4Vdc @ load ≥ 50%
Low DC Warning Return Voltage (Lead-Acid Mode)	23.0Vdc @ load < 20% 22.4Vdc @ 20% ≤ load < 50% 21.2Vdc @ load ≥ 50%	46.0Vdc @ load < 20% 44.8Vdc @ 20% ≤ load < 50% 42.4Vdc @ load ≥ 50%
Low DC Cut-off Voltage (Lead-Acid Mode)	21.0Vdc @ load < 20% 20.4Vdc @ 20% ≤ load < 50% 19.2Vdc @ load ≥ 50%	42.0Vdc @ load < 20% 40.8Vdc @ 20% ≤ load < 50% 38.4Vdc @ load ≥ 50%
Low DC Cut-off Voltage (Li Mode)	21.0Vdc	42.0Vdc
Low DC Warning SOC (Li Mode)	Low DC Cut-off SOC +5%	
Low DC Warning Return SOC (Li Mode)	Low DC Cut-off SOC +10%	
Low DC Cut-off SOC (Li Mode)	Default 20%, 5%~30% settable	
High DC Recovery Voltage	28.2Vdc(C.V. charging voltage)	56.4Vdc(C.V. charging voltage)
High DC Cut-off Voltage	30.4Vdc	60.8Vdc
No Load Power Consumption	<50W	

Table 4 Charge Mode Specifications

Utility Charging Mode		
INVERTER MODEL	RS-H3000-24	RS-H3000-48
Charging Current (UPS) @ Nominal Input Voltage	Default: 30A, max 60A	Default: 30A, max 40A
Bulk Charging Voltage	Flooded Battery	29.2Vdc
	AGM / Gel Battery	28.2Vdc
Floating Charging Voltage	27Vdc	54Vdc
Overcharge Protection	30Vdc	60Vdc
Charging Algorithm	3-Step	
Charging Curve	<p>Battery Voltage, per cell</p> <p>Charging Current, %</p> <p>2.43Vdc (2.35Vdc) 2.25Vdc</p> <p>Voltage</p> <p>100%</p> <p>50%</p> <p>Current</p> <p>Time</p> <p>T0</p> <p>T1</p> <p>T1 = 10 * T0, minimum 10mins, maximum 8hrs</p> <p>Bulk (Constant Current)</p> <p>Absorption (Constant Voltage)</p> <p>Maintenance (Floating)</p>	
Solar Charging Mode		
Efficiency	98.0% max.	
Max. PV Array Open Circuit Voltage	145Vdc	
PV Array MPPT Voltage Range	30~115Vdc	60~115Vdc
Min battery voltage for PV charge	17Vdc	34Vdc
Max PV Charging current	80A	
Battery Voltage Accuracy	+/-0.3%	
PV Voltage Accuracy	+/-2V	
Charging Algorithm	3-Step	
Joint Utility and Solar Charging		
Max Charging Current	140Amp	120Amp
Default Charging Current	60Amp	

TROUBLE SHOOTING

Problem	LCD/LED/Buzzer	Explanation	What to do
Unit shuts down Automatically during startup process.	LCD/LEDs and buzzer will be active for 3 seconds and then complete off.	The battery voltage is too low . (<1.91V/Cell)	1.Re-charge battery. 2.Replace battery.
No response after power on.	No indication.	1.The battery voltage is far too low. (<1.4V/Cell) 2.Battery polarity is connected reversed.	1. Check if batteries and the wiring are connected well. 2.Re-charge battery. 3.Replace battery.
Mains exist but the unit works in battery mode.	Input voltage is 0 on the LCD and green LED is flashing.	Input protector is tripped.	Check if AC breaker is tripped and AC wiring is connected well.
	Green LED is flashing.	Insufficient quality of AC power. (Shore or Generator)	1. Check if AC wires are too thin and/or too long. 2. Check if generator (if applied) is working well or if input voltage range setting is correct. (UPS→Appliance)
	Green LED is flashing.	Set "Battery First" or "Solar First" as the priority of output source.	Change output source priority to Utility first.
When it's turned on, internal relay is switching on and off repeatedly.	LCD display and LEDs are flashing	Battery is disconnected.	Check if battery wires are connected well.
Buzzer beeps continuously and red LED is on.(Fault code) Buzzer beeps once every second, and red LED is flashing. (Warning code)	Fault code 01	Fan fault.	1.Check whether all fans are working properly. 2.Replace the fan.
	Fault code 02	Internal temperature of component is over 100°C.	1.Check whether the air flow of the unit is blocked or whether the ambient temperature is too high. 2.Check whether the thermistor plug is loose.
	Fault code 03	Battery is over-charged.	Restart the unit, if the error happens again, please return to repair center.
		The battery voltage is too high.	Check if spec and quantity of batteries are meet requirements.
	Warning code 04	The battery voltage/SOC is too low.	1.Measure battery voltage in DC input. 2.Check battery SOC in LCD when use Li battery. 3.Recharge the battery.
	Fault code 05	Output short circuited.	Check if wiring is connected well and remove abnormal load.
	Fault code 06/58	Output abnormal (Inverter voltage is higher than 150Vac or less than 40Vac).	1.Reduce the connected load. 2. Restart the unit, if the error happens again, please return to repair center.
	Fault code 07	The inverter is overload 110% and time is up.	Reduce the connected load by switching off some equipment.
	Fault code 08	Bus voltage is too high.	1.If you connect to a lithium battery without communication, check whether the voltage points of the program 19 and 21 are too high for the lithium battery. 2. Restart the unit, if the error happens again, please return to repair center.
	Fault code 09/53/57	Internal components failed.	Restart the unit, if the error happens again, please return to repair center.
	Warning code 15	The input status is different in parallel system.	Check if AC input wires of all inverters are connected well.
	Warning code 16	Input phase is not correct.	Change the input phase S and T wiring.
	Warning code 17	The output phase not correct in parallel.	1.Make sure the parallel setting are the same system(single or parallel; 3P1,3P2,3P3). 2.Make sure all phases inverters are power on.
	Warning code 20	Li battery can't communicate to the inverter.	1.Check whether communication line is correct connection between inverter and battery. 2.Check whether BMS protocol type is correct setting.
	Fault code 51	Over current or surge.	Restart the unit, if the error happens again, please return to repair center.
Fault code 52	Bus voltage is too low.		
Fault code 55	Output voltage is unbalanced		
Fault code 56	Battery is not connected well or fuse is burnt.	If the battery is connected well, please return to repair center.	

	Fault code 60	Negative power fault	<ol style="list-style-type: none"> 1. Check whether the AC output connected to the grid input. 2. Check whether Program 8 settings are the same for all parallel inverters 3. Check whether the current sharing cables are connected well in the same parallel phases. 4. Check whether all neutral wires of all parallel units are connected together. 5. If problem still exists, contact repair center.
	Fault code 80	CAN fault	<ol style="list-style-type: none"> 1. Check whether the parallel communication cables are connected well. 2. Check whether Program 23 settings are right for the parallel system.
	Fault code 81	Host loss	<ol style="list-style-type: none"> 3. If problem still exists, contact repair center

Note: To restart the inverter, all power sources need to be disconnected. After the LCD screen light is off, only use the battery to boot.

 1-800-831-9889

 sales@richsolar.com

 www.richsolar.com

 5550 Jurupa St, Ontario, CA 91761