

User Manual

Hybrid LV 12KW PV Inverter 12000W



MODEL: RS-H12K

Table Of Contents

01	Introduction
02	Important Safety Warning
04	Unpacking & Overview Packing List Product Overview
05	Installation Precaution Selecting Mounting Location Mounting Unit
07	Grid (Utility) Connection Preparation Connecting to the AC Utility
08	Generator Connection Preparation Connecting to the Generator Input
09	PV Module (DC) Connection
12	Battery Connection
13	Load (AC Output) Connection Preparation Connecting to the AC output
14	Communication Wi-Fi Connection Pin Assignment for RS 232 Communication Port Pin Assignment for BMS Communication Port Dry Contact Signal
17	Commissioning
18	Initial Setup
31	Operation Interface LCD Information Define Touchable function keys SW ON/OFF Operation (located on the side of the inverter) LCD Setting Query Menu Operation Operation Mode & Display
50	Charging Management
52	Maintenance & Cleaning
53	Trouble Shooting Warning List Fault Reference Codes
57	Specifications
	Appendix I: Parallel Installation Guide
	Appendix II: The Wi-Fi Operation Guide
	Appendix III: The CT Operation Guide
	Appendix IV : The Generator Operation Guide

1. Introduction

This hybrid PV inverter can provide power to connected loads by utilizing PV power, utility power and battery power.

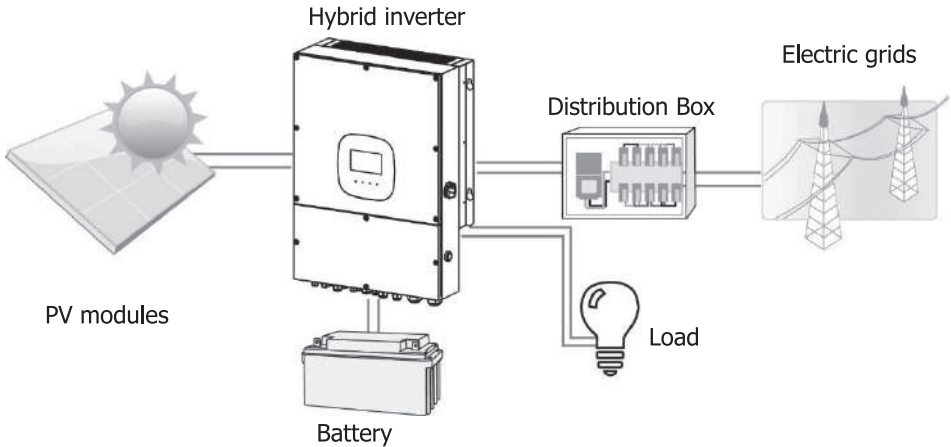

Figure 1 Basic hybrid PV System Overview

Depending on different power situations, this hybrid inverter is designed to generate continuous power from PV solar modules (solar panels), battery, and the utility. When MPP input voltage of PV modules is within acceptable range (see specification for the details), this inverter is able to generate power to feed the grid (utility) and charge battery. This inverter is only compatible with PV module types of single crystalline and poly crystalline. Do not connect any PV array types other than these two types of PV modules to the inverter. Do not connect the positive or negative terminal of the solar panel to the ground. See Figure 1 for a simple diagram of a typical solar system with this hybrid inverter.

2. Important Safety Warning

Before using the inverter, please read all instructions and cautionary markings on the unit and this manual. Store the manual where it can be accessed easily.

This manual is for qualified personnel. The tasks described in this manual may be performed by qualified personnel only.

General Precaution-

Conventions used:

WARNING! Warnings identify conditions or practices that could result in personal injury;

CAUTION! Caution identify conditions or practices that could result in damaged to the unit or other equipment connected.



WARNING! Before installing and using this inverter, read all instructions and cautionary markings on the inverter and all appropriate sections of this guide.



WARNING! Normally grounded conductors may be ungrounded and energized when a ground fault is indicated.



WARNING! This inverter is heavy. It should be lifted by at least two persons.



CAUTION! Authorized service personnel should reduce the risk of electrical shock by disconnecting AC, DC and battery power from the inverter before attempting any maintenance or cleaning or working on any circuits connected to the inverter. Turning off controls will not reduce this risk. Internal capacitors can remain charged for 5 minutes after disconnecting all sources of power.

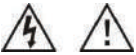

CAUTION! Do not disassemble this inverter yourself. It contains no user-serviceable parts. Attempt to service this inverter yourself may cause a risk of electrical shock or fire and will void the warranty from the manufacturer.

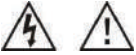

CAUTION! To avoid a risk of fire and electric shock, make sure that existing wiring is in good condition and that the wire is not undersized. Do not operate the Inverter with damaged or substandard wiring.



CAUTION! Under high temperature environment, the cover of this inverter could be hot enough to cause skin burns if accidentally touched. Ensure that this inverter is away from normal traffic areas.



CAUTION! Use only recommended accessories from installer. Otherwise, not-qualified tools may cause a risk of fire, electric shock, or injury to persons.



CAUTION! To reduce risk of fire hazard, do not cover or obstruct the cooling fan.



CAUTION! Do not operate the Inverter if it has received a sharp blow, been dropped, or otherwise damaged in any way. If the Inverter is damaged, please call for an RMA (Return Material Authorization).



CAUTION! AC breaker, DC switch and Battery circuit breaker are used as disconnect devices and these disconnect devices shall be easily accessible.

Before working on this circuit

- Isolate inverter/Uninterruptible Power System (UPS)
- Then check for Hazardous Voltage between all terminals including the protective earth.



Risk of Voltage Backfeed.

Symbols used in Equipment Markings

	Refer to the operating instructions.
	Caution! Risk of danger.
	Caution! Risk of electric shock.
	Caution! Risk of electric shock. Energy storage timed discharge for 5 minutes.
	Caution! Hot surface.

3. Unpacking & Overview

3-1. Packing List

Before installation, please inspect the unit. Be sure that nothing inside the package is damaged. You should have received the following items inside of package:

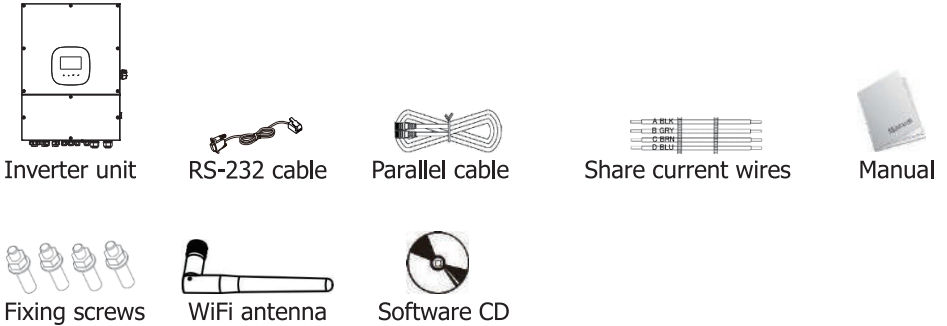

3-2. Product Overview

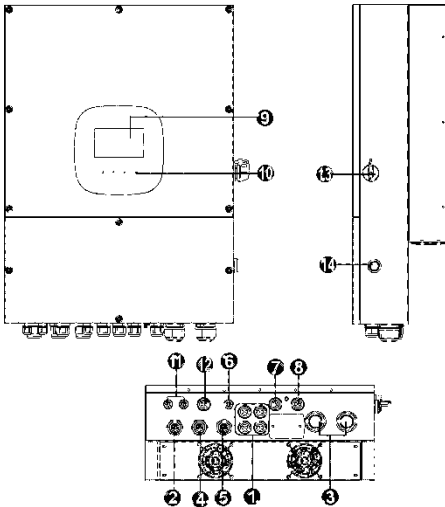

- 1) PV connectors
- 2) AC Grid connectors
- 3) Battery connectors
- 4) AC output connectors (Load connection)
- 5) Generator input
- 6) External sensor port (reserved)
- 7) Dry contact & USB communication port
- 8) BMS & RS-232 communication port
- 9) LCD display panel (Please check section 10 for detailed LCD operation)
- 10) Operation buttons
- 11) Current sharing port
- 12) Parallel communication port
- 13) PV switch
- 14) Power on/off switch

4. Installation

4-1. Precaution

This hybrid inverter is designed for indoor or outdoor use (IP65), please make sure the installation site meets below conditions:

- Not in direct sunlight.
- Not in areas where highly flammable materials are stored.
- Not in potential explosive areas.
- Not in the cool air directly.
- Not near the television Antenna or antenna cable.
- Not higher than altitude of about 2000 meters above sea level.
- Not in environment of precipitation or humidity (>95%).

Please AVOID direct sunlight, rain exposure, snow laying up during installation and operation.

4-2. Selecting Mounting Location

- Please select a vertical wall with load-bearing capacity for installation, appropriate for installation on concrete or other non-flammable surfaces.
- The ambient temperature should be between -25~60°C to ensure optimal operation.
- Be sure to keep other objects and surfaces as shown in the diagram to guarantee sufficient heat dissipation and have enough space for removing wires.
- For proper air ventilation to dissipate heat, allow a clearance of approx. 50cm to the side and approx. 50cm above and below the unit. And 100cm toward the front.

4.3. Mounting Unit

WARNING!! Remember that this inverter is heavy! Please be carefully when lifting out from the package.

Installation to the wall should be implemented with the proper screws. After that, the device should be bolted on securely.

The inverter only can be used in a CLOSED ELECTRICAL OPERATING AREA. Only service person can enter into this area.

WARNING!! FIRE HAZARD.
SUITABLE FOR MOUNTING ON CONCRETE OR OTHER NON-COMBUSTIBLE SURFACE ONLY.

1. Fix four screws as shown in the chart (width: 487mm, height: 350mm). The reference tightening torque is 35 N.m.

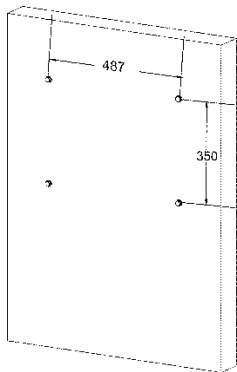

2. Raise the inverter and place it over the four screws.

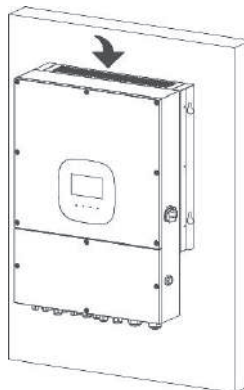

3. Check if the inverter is firmly secured.

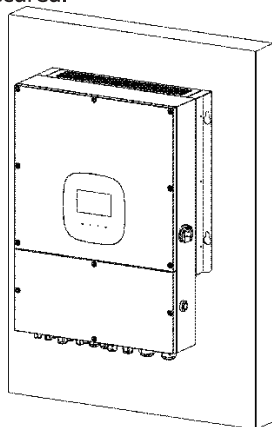

5. Grid (Utility) Connection

5-1. Preparation

NOTE 1: The overvoltage category of the AC input is III. It should be connected to the power distribution.

NOTE 2: Before connecting to grid, please install a separate AC breaker between inverter and grid. This will ensure the inverter can be securely disconnected during maintenance and fully protected from over current. The recommended of AC breaker is 40A/300V.

WARNING! It's very important for system safety and efficient operation to use appropriate cable for grid (utility) connection. To reduce risk of injury, please use the proper recommended cable size as below.

Suggested cable requirement for AC wire

Nominal Grid Voltage	120VAC per phase
Conductor cross-section (mm ²)	10-16
AWG no.	8-6

5-2. Connecting to the AC Utility

Please follow below steps to implement AC input connection:

1. Before making AC input connection, be sure to open DC protector or disconnector first.
2. Remove insulation sleeve 7mm for four conductors.
3. Insert AC input wires according to polarities indicated on terminal block and tighten the terminal screws. Be sure to connect PE protective conductor (⊕) first.

⊕ → **Ground (yellow-green)**

L1 → **LINE (black)**

L2 → **LINE (brown)**

N → **Neutral (blue)**

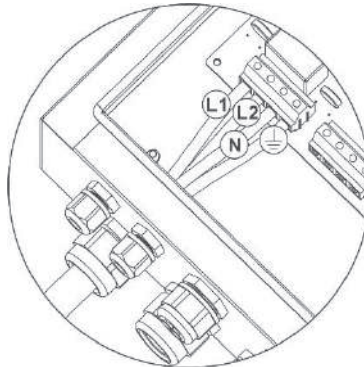

**WARNING:**

Be sure that AC power source is disconnected before attempting to hardwire it to the unit.

6. Generator Connection

6-1. Preparation

NOTE 1: The overvoltage category of the AC input is III. It should be connected to the power distribution.

NOTE 2: Before connecting to grid, please install a separate AC breaker between inverter and grid. This will ensure the inverter can be securely disconnected during maintenance and fully protected from over current. The recommended of AC breaker is 40A/300V.

WARNING! It's very important for system safety and efficient operation to use appropriate cable for generator connection. To reduce risk of injury, please use the proper recommended cable size as below.

Suggested cable requirement

Nominal Grid Voltage	120VAC per phase
Conductor cross-section (mm ²)	10-16
AWG no.	8-6

6-2. Connecting to the Generator Input

Please follow below steps to implement generator input connection:

1. Before making generator input connection, be sure to open DC protector or disconnecter first.
2. Remove insulation sleeve 7mm for four conductors.
3. Insert input wires according to polarities indicated on terminal block and tighten the terminal screws. Be sure to connect PE protective conductor (⊕) first.

L1→LINE (black)

L2→LINE (brown)

N→Neutral (blue)

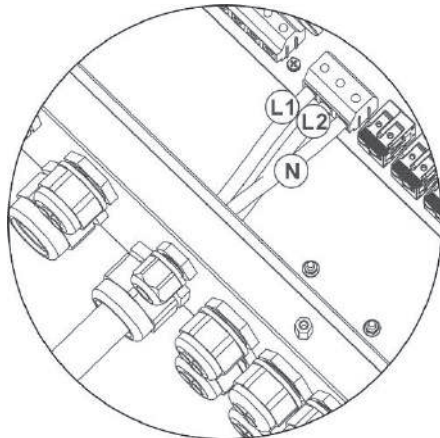

**WARNING:**

Be sure that AC power source is disconnected before attempting to hardwire it to the unit.

7. PV Module (DC) Connection

CAUTION: Before connecting to PV modules, please install **separately** a DC circuit breaker between inverter and PV modules.

NOTE1: Please use 1000VDC/20A circuit breaker.

NOTE2: The overvoltage category of the PV input is II.

Please follow below steps to implement PV module connection:

WARNING: Because this inverter is non-isolated, only two types of PV modules are acceptable: single crystalline and poly crystalline with class A-rated.

To avoid any malfunction, do not connect any PV modules with possibility of leakage current to the inverter. For example, grounded PV modules will cause leakage current to the inverter.

CAUTION: It's requested to have PV junction box with surge protection. Otherwise, it will cause inverter damage when lightning occurs on PV modules.

Step 1: Check the input voltage of PV array modules. The acceptable input voltage of the inverter is 120VDC - 600VDC. This system is applied with two strings of PV array. Please make sure that the maximum current load of each PV input connector is 18A.

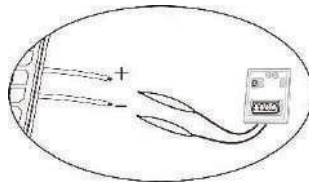

CAUTION: Exceeding the maximum input voltage can destroy the unit!! Check the system before wire connection.

Step 2: Disconnect the circuit breaker and switch off the DC switch.

Step 3: Remove insulation sleeve 7 mm for positive and negative conductors.

Step 4: Check correct polarity of connection cable from PV modules and PV input connectors. Then, connect positive pole (+) of connection cable to positive pole (+) of PV input connector. Connect negative pole (-) of connection cable to negative pole (-) of PV input connector.

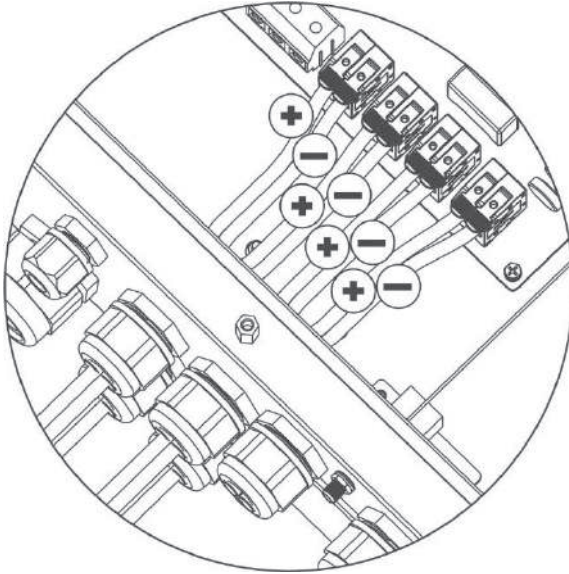

WARNING! It's very important for system safety and efficient operation to use appropriate cable for PV module connection. To reduce risk of injury, please use the proper recommended cable size as below.

Conductor cross-section (mm ²)	AWG no.
4	12

CAUTION: Never directly touch terminals of the inverter. It will cause lethal electric shock.

CAUTION: Do NOT touch the inverter to avoid electric shock. When PV modules are exposed to sunlight, it may generate DC voltage to the inverter.

Recommended Panel Configuration

Specifications	Solar panel			
Nominal Max. Power (Pmax) (W)	520	535	560	580
Opt. Operating Voltage (Vmp) (V)	41.6	41.9	44.31	44.78
Opt. Operating Current (Imp) (A)	12.5	12.77	12.64	12.96
Open Circuit Voltage (Voc) (V)	49.14	49.44	52.90	53.30
Short Circuit Current (Isc) (A)	13.23	13.5	13.50	13.82
For 12KW input recommendation				
Numbers in series of MPPT1	11	11	10	10
Numbers of strings in MPPT1	1	1	1	1
Maximum input voltage of MPPT1 (V)	540.5	543.8	529	533
Input power of MPPT1 (W)	5720	5885	5600	5800
Numbers in series of MPPT2	11	11	10	10
Numbers of strings in MPPT2	1	1	1	1
Maximum input voltage of MPPT1 (V)	540.5	543.8	529	533
Input power of MPPT2 (W)	5720	5885	5600	5800
Total input power (W)	11440	11770	11200	11600
Minimum input recommendation				
Numbers in series of MPPT1	4	4	4	4
Numbers of strings in MPPT1	1	1	1	1
Maximum input voltage of MPPT1 (V)	196.6	197.6	211.6	213.2
Input power of MPPT1 (W)	2080	2140	2240	2320
Numbers in series of MPPT2	4	4	4	4
Numbers of strings in MPPT2	1	1	1	1
Maximum input voltage of MPPT1 (V)	196.6	197.6	211.6	213.2
Input power of MPPT2 (W)	2080	2140	2240	2320
Total input power (W)	4160	4280	4480	4640

8. Battery Connection

CAUTION: Before connecting to batteries, please install **separately** a DC circuit breaker between inverter and batteries.

NOTE1: Please only use sealed lead acid battery, vented and Gel battery. Please check maximum charging voltage and current when first using this inverter. If using Lithium iron or Nicd battery, please consult with installer for the details.

NOTE2: Please use 60VDC/250A circuit breaker.

NOTE3: The overvoltage category of the battery input is II.

Please follow below steps to implement battery connection:

Step 1: Check the nominal voltage of batteries. The nominal input voltage for inverter is 48VDC.

Step 2: Use two battery cables. Remove insulation sleeve 10 mm and insert conductor into cable ring terminal. Refer to right chart.

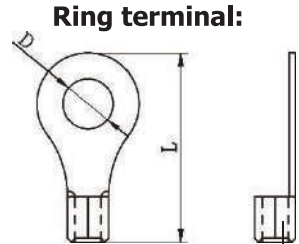

Recommended battery cable and terminal size for each inverter:

Wire Size	Cable mm ²	Ring Terminal Dimensions		Torque value
		D (mm)	L (mm)	
		3/0AWG	85	

WARNING: Be sure the length of all battery cables is the same. Otherwise, there will be voltage difference between inverter and battery to cause parallel inverters not working.

Step 3: Insert battery wires according to polarities indicated on the terminal block and tighten the terminal screws. Make sure polarity at both the battery and the inverter/charge is correctly connected.

RED cable to the positive terminal (+);

BLACK cable to the negative terminal (-).

WARNING! Wrong connections will damage the unit permanently.

Step 4: Make sure the wires are securely connected. The reference tightening torque is 5.5~7.0 N.m.

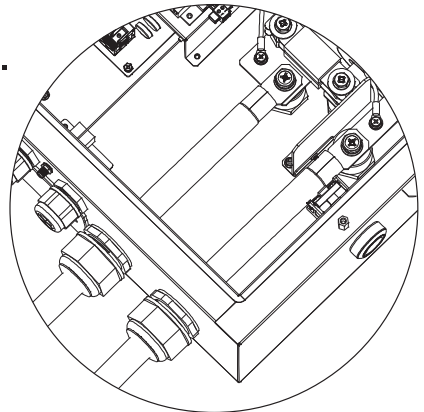

WARNING! It's very important for system safety and efficient operation to use appropriate cable for battery connection. To reduce risk of injury, please use the proper recommended cable size as below.

Nominal Battery Voltage	48V
Conductor cross-section (mm ²)	85
AWG no.	3/0
Protective earthing (battery side)	150mm ² (300kcmil)

9. Load (AC Output) Connection

9-1. Preparation

CAUTION: To prevent further supply to the load via the inverter during any mode of operation, an additional disconnection device should be placed on in the building wiring installation.

WARNING! It's very important for system safety and efficient operation to use appropriate cable for AC connection. To reduce risk of injury, please use the proper recommended cable size as below.

Nominal Grid Voltage	120/208/240 VAC per phase
Conductor cross-section (mm ²)	10-16
AWG no.	8-6

9-2. Connecting to the AC output

Step 1: Before making output connection, be sure to open DC protector or disconnector first.

Step 2: Remove insulation sleeve 7mm for four conductors.

Step 3: Insert AC input wires according to polarities indicated on terminal block and tighten the terminal screws. Be sure to connect PE protective conductor (⊕) first.

⊕ → **Ground (yellow-green)**

L1 → **LINE (black)**

L2 → **LINE (brown)**

N → **Neutral (blue)**

The reference tightening torque is 1.0-1.5 N.m.

Step 4: Make sure the wires are securely connected.

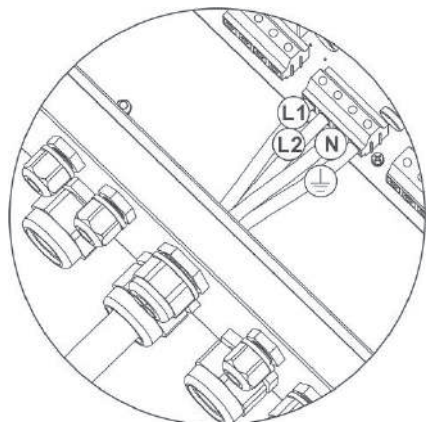

CAUTION: Do NOT connect the utility to “AC Output Connector (Load connector)”.

CAUTION: Be sure to connect L terminal of load to L terminal of “AC Output Connector(Load connector)” and N terminal of load to N terminal of “AC Output Connector(Load connector)”. The G terminal of “AC Output Connector” is connected to grounding of the load. Do NOT mis-connect.

CAUTION: Appliances such as air conditioner are required at least 2~3 minutes to restart because it's required to have enough time to balance refrigerant gas inside of circuits. If a power shortage occurs and recovers in a short time, it will cause damage to your connected appliances. To prevent this kind of damage, please check manufacturer of air conditioner if it's equipped with time-delay function before installation. Otherwise, this inverter/charger will trig overload fault and cut off output to protect your appliance but sometimes it still causes internal damage to the air conditioner.

10. Communication

The inverter is equipped with several communication ports to communicate with a PC with corresponding software. Follow below procedure to connect communication wiring and install the software.

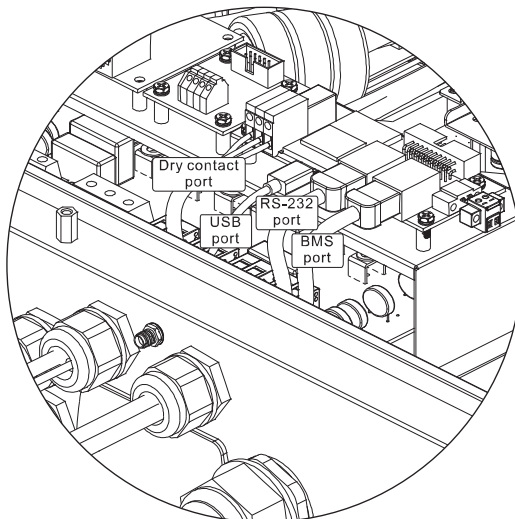

Please install monitoring software in your computer. Detailed information is listed in the next chapter. After software is installed, you may initial the monitoring software and extract data through communication port.

10-1. Wi-Fi Connection

This unit is equipped with a Wi-Fi transmitter. Wi-Fi transmitter can enable wireless communication between off-grid inverters and monitoring platform. Users can access and control the monitored inverter with downloaded APP. You may find "i.Solar" app from the Apple® Store and Google® Play Store. All data loggers and parameters are saved in iCloud. For quick installation and operation, please refer to Appendix II - The Wi-Fi Operation Guide for details.

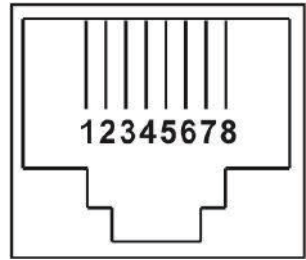

10-2. Pin Assignment for RS-232 Communication Port

	Definition
PIN 1	RS232TX
PIN 2	RS232RX
PIN 3	NC
PIN 4	NC
PIN 5	NC
PIN 6	NC
PIN 7	NC
PIN 8	GND

10-3. Pin Assignment for BMS Communication Port

	Definition
PIN 1	RS232TX
PIN 2	RS232RX
PIN 3	RS485B
PIN 4	NC
PIN 5	RS485A
PIN 6	CANH
PIN 7	CANL
PIN 8	GND

10-4. Dry Contact Signal

There is one dry contact available on the bottom panel. It could be used to remote control for external generator.

Electric Parameter

Parameter	Symbol	Max.	Unit
Relay DC voltage	Vdc	30	V
Relay DC current	Idc	1	A

Note: The application of the dry contact should not exceed the electric parameter shown as above. Otherwise, the internal relay will be damaged.

Function Description

Unit Status	Condition	 Dry contact port: NC C NO	
		NO&C	NC&C
Power Off	Unit is off and no output is powered.	Open	Close
Power On	Battery voltage is lower than setting battery cut-off discharging voltage when grid is available.	Close	Open
	Battery voltage is lower than setting battery cut-off discharging voltage when grid is unavailable.	Close	Open
	Battery voltage is higher than below 2 setting values: 1. Battery re-discharging voltage when grid is available. 2. Battery re-discharging voltage when grid unavailable.	Open	Close

You can set the related parameters in software. Refer to below chart:

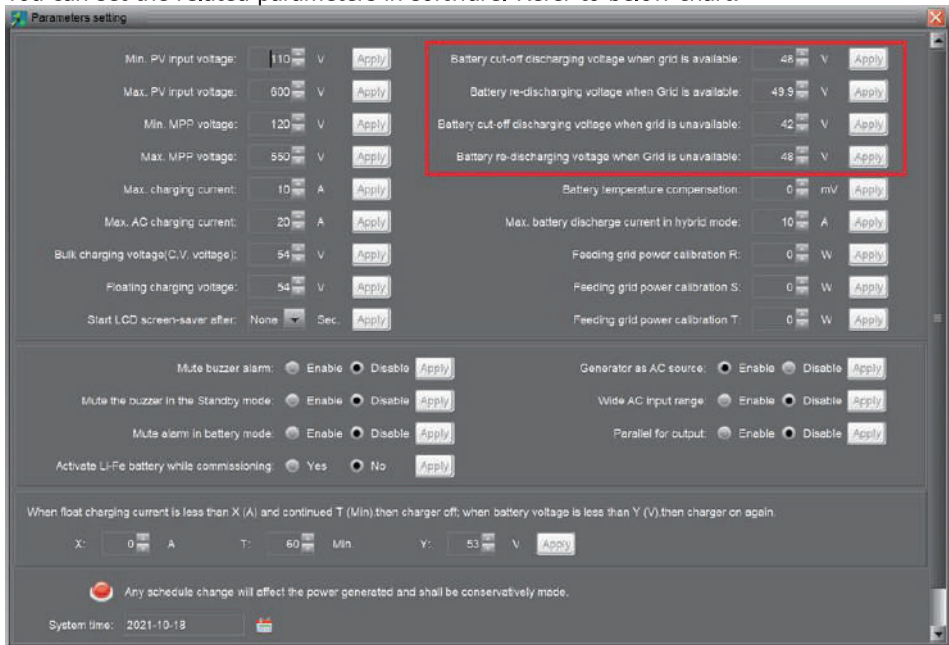

The screenshot shows the 'Parameters setting' window with the following parameters and values:

- Min. PV input voltage: 110 V
- Max. PV input voltage: 600 V
- Min. MPP voltage: 120 V
- Max. MPP voltage: 550 V
- Max. charging current: 10 A
- Max. AC charging current: 20 A
- Bulk charging voltage(C.V. voltage): 54 V
- Floating charging voltage: 54 V
- Start LCD screen-saver after: None Sec.
- Battery cut-off discharging voltage when grid is available: 48 V
- Battery re-discharging voltage when Grid is available: 49.5 V
- Battery cut-off discharging voltage when Grid is unavailable: 42 V
- Battery re-discharging voltage when Grid is unavailable: 48 V
- Battery temperature compensation: 0 mV
- Max. battery discharge current in hybrid mode: 10 A
- Feeding grid power calibration R: 0 W
- Feeding grid power calibration S: 0 W
- Feeding grid power calibration T: 0 W
- Mute buzzer alarm: Enable/Disable
- Mute the buzzer in the Standby mode: Enable/Disable
- Mute alarm in battery mode: Enable/Disable
- Activate Li-Fe battery while commissioning: Yes/No
- Generator as AC source: Enable/Disable
- Wide AC input range: Enable/Disable
- Parallel for output: Enable/Disable
- When float charging current is less than X (A) and continued T (Min) then charger off; when battery voltage is less than Y (V) then charger on again.
 - X: 0 A
 - T: 60 Min
 - Y: 53 V

System time: 2021-10-18

11. Commissionin

Step 1: Check the following requirements before commissioning:

- Ensure the inverter is firmly secured
- Check if the open circuit DC voltage of PV module meets requirement (Refer to Section 6)
- Check if the open circuit utility voltage of the utility is at approximately same to the nominal expected value from local utility company.
- Check if connection of AC cable to grid (utility) is correct if the utility is required.
- Full connection to PV modules.
- AC circuit breaker (only applied when the utility is required), batter circuit breaker, and DC circuit breaker are installed correctly.

Step 2: Switch on the battery circuit breaker and then switch on PV DC breaker. After that, if there is utility connection, please switch on the AC circuit breaker. At this moment, the inverter is turned on already. However, there is no output generation for loads. Then:

- If LCD lights up to display the current inverter status, commissioning has been successfully. After pressing "ON" button for 1 second when the utility is detected, this inverter will start to supply power to the loads. If no utility exists, simply press "ON" button for 3 seconds. Then, this inverter will start to supply power to the loads.
- If a warning/fault indicator appears in LCD, an error has occurred to this inverter. Please inform your installer.

Step 3: Please insert CD into your computer and install monitoring software in your PC. Follow below steps to install software.

1. Follow the on-screen instructions to install the software.
2. When your computer restarts, the monitoring software will appear as shortcut icon located in the system tray, near the clock.

12. Initial Setup

Before inverter operation, it's required to set up "Operation Mode" via software. Please strictly follow below steps to set up. For more details, please check software manual.

Step 1: After turning on the inverter and installing the software, please click "Open Monitor" to enter main screen of this software.

Step 2: Log in into software first by entering default password "administrator".

Step 3: Select Device Control>>MyPower Management. It is to set up inverter operation mode and personalized interface. Refer to diagram below.

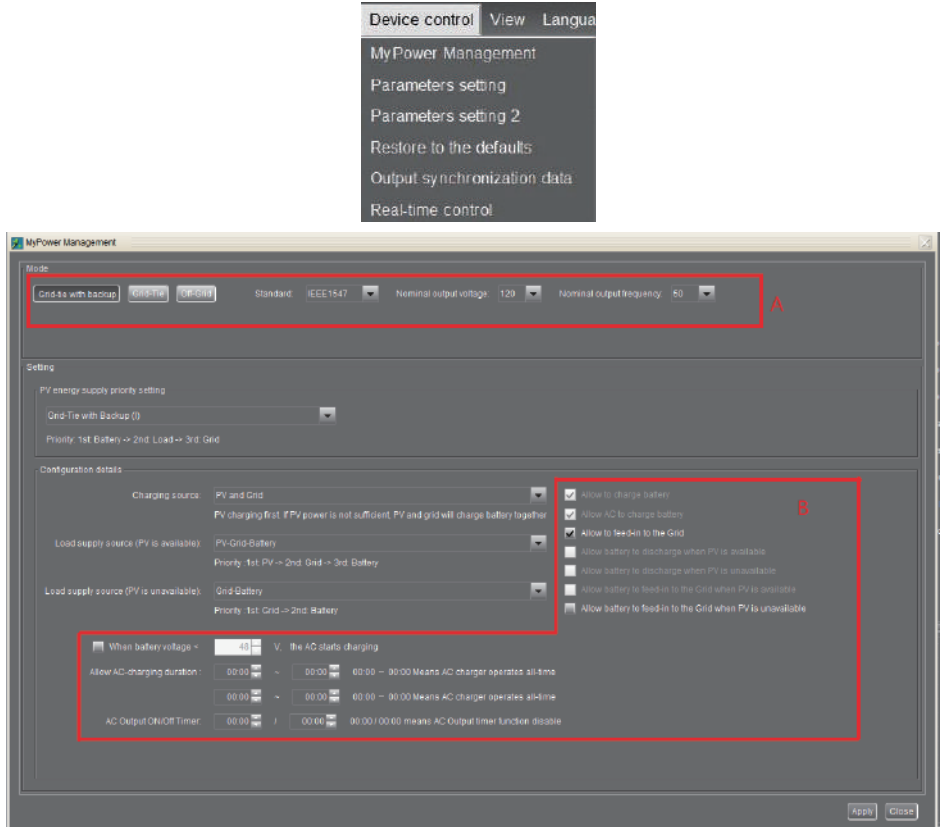

SECTION A:

Mode (Refer to LCD setting 13)

There are three operation modes: Grid-tie with backup, Grid-Tie and Off-Grid.

- Grid-tie with backup: PV power can feed-in back to grid, provide power to the load and charge battery. There are four options available in this mode: Grid-tie with backup I, II, III and IV. In this mode, users can configure PV power supply priority, charging source priority and load supply source priority. However, when Grid-tie with

backup IV option is selected in PV energy supply priority, the inverter is only operated between two working logics based on defined peak time and off-peak time of electricity. Only peak time and off-peak time of electricity are able to set up for optimized electricity usage.

- Grid-Tie: PV power only can feed-in back to grid.
- Off-Grid: PV power only provides power to the load and charge battery. No feed-in back to grid is allowed.

Standard (It can only be modified by software)

It will list local grid standard. It's requested to have factory password to make any modifications. Please check local dealer only when this standard change is requested.

CAUTION: Wrong setting could cause the unit damage or not working.

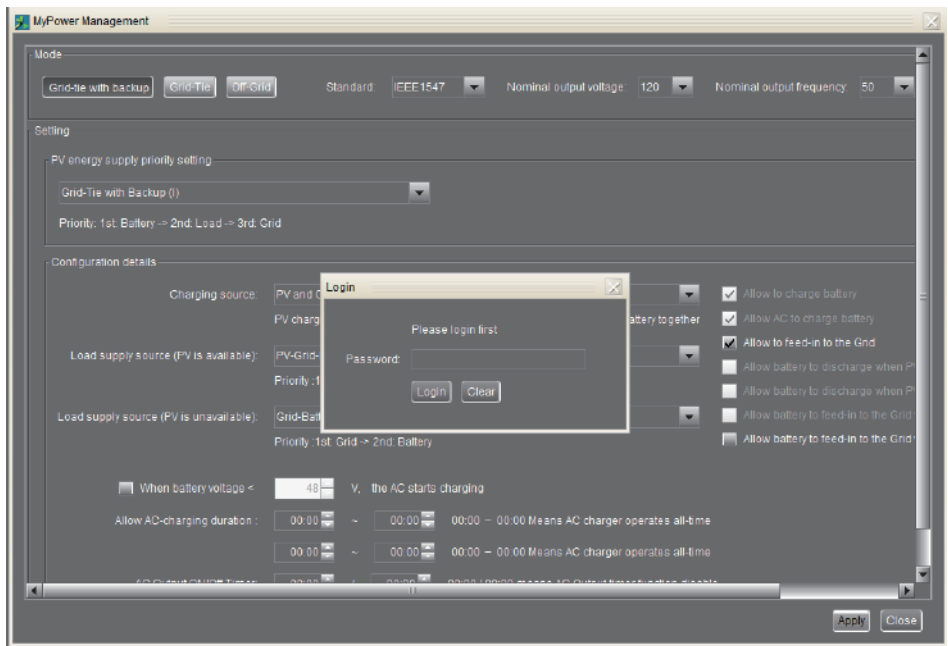

Nominal Output Voltage (Refer to LCD setting 01)

The factory default voltage is 120V. You can select 110V or 120V as required.

Nominal Output Frequency (Refer to LCD setting 02)

The factory default frequency is 60hz. You can select 50Hz or 60Hz as required.

SECTION B: Setting

This section contents may be different based on different selected types of operations.

Allow AC charging duration (Refer to LCD setting 21-24)

It's a period time to allow AC (grid) to charge battery. When the duration is set up as 0:00-00:00, it means no time limitation for AC to charge battery.

AC output ON/Off Timer (Refer to LCD setting 25, 26)

Set up on/off time for AC output of inverter. If setting it as 00:00/00:00, this function is disabled.

Allow to charge battery (Refer to LCD setting 15)

This option is automatically determined by setting in "Charging source". It's not allowed to modify here. When "NONE" is selected in charging source section, this option becomes unchecked as grey text.

Allow AC to charge battery (Refer to LCD setting 15)

This option is automatically determined by setting in "Charging source". It's not allowed to modify here. When "Grid and PV" or "Grid or PV" is selected in charging source section, this option is default selected. Under Grid-tie mode, this option is invalid.

Allow to feed-in to the Grid (Refer to LCD setting 16)

This option is only valid under Grid-tie and Grid-tie with backup modes. Users can decide if this inverter can feed-in to the grid.

Allow battery to discharge when PV is available

This option is automatically determined by setting in "Load supply source (PV is available)". When "Battery" is higher priority than "Grid" in Load supply source (PV is available), this option is default selected. Under Grid-tie, this option is invalid.

Allow battery to discharge when PV is unavailable

This option is automatically determined by setting in "Load supply source (PV is unavailable)". When "Battery" is higher priority than "Grid" in Load supply source (PV is unavailable), this option is default selected. Under Grid-tie mode, this option is invalid.

Allow battery to feed-in to the Grid when PV is available (Refer to LCD setting 17)

This option is only valid in Grid-tie with backup II or Grid-tie with backup III modes.

Allow battery to feed-in to the Grid when PV is unavailable (Refer to LCD setting 16)

This option is only valid in all options of Grid-tie with backup mode.

PV energy support priority setting (Refer to LCD setting 14)

It will affect the selection of "Battery charging source (LCD setting 15)", "Load supply source (LCD setting 19 and 20)".

Grid-tie with backup

- Grid-tie with backup (I) :

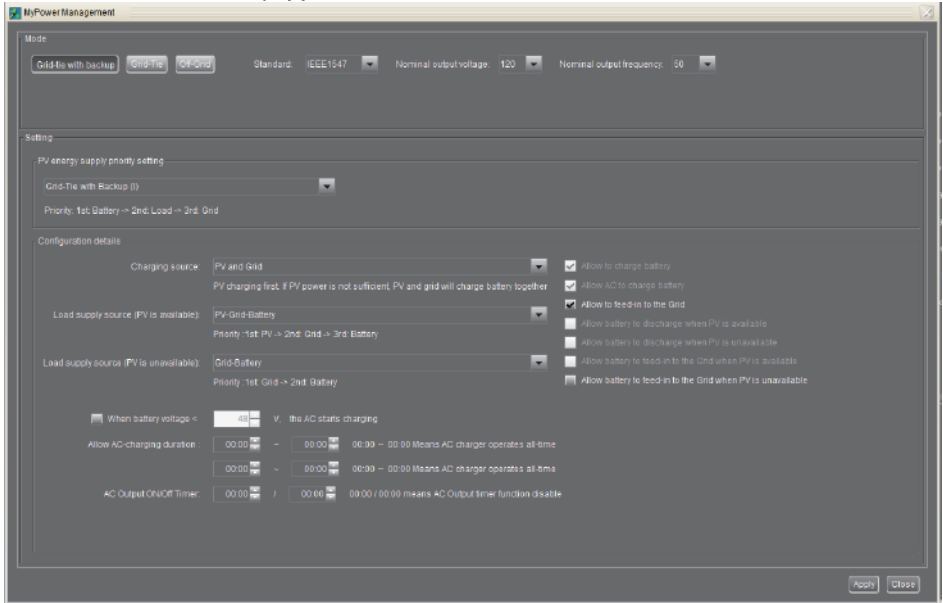

PV energy supply priority setting: 1st Battery, 2nd Load and 3rd Grid.

PV power will charge battery first, then provide power to the load. If there is any remaining power left, it will feed-in to the grid.

Battery charging source:

1. PV and Grid (Default)

It's allowed to charge battery from PV power first. If it's not sufficient, grid will charge battery.

2. PV only

It is only allow PV power to charge battery.

3. None

It is not allowed to charge battery no matter it's from PV power or grid.

Load supply source: (also refer to LCD setting 19 and 20)

When PV power is available: 1st PV, 2nd Grid, 3rd Battery

If battery is not fully charged, PV power will charge battery first. And remaining PV power will provide power to the load. If it's not sufficient, grid will provide power to the load. If grid is not available at the same time, battery power will back up.

When PV power is not available:

1. 1st Grid, 2nd Battery (Default)

Grid will provide power to the load at first. If grid is not available, battery power will provide power backup.

2. 1st Battery, 2nd Grid

Battery power will provide power to the load at first. If battery power is running out, grid will back up the load.

NOTE: This option will become ineffective during AC charging time and the priority will automatically become 1st Grid and 2nd Battery order. Otherwise, it will cause battery damage.

● Grid-tie with backup (II) :

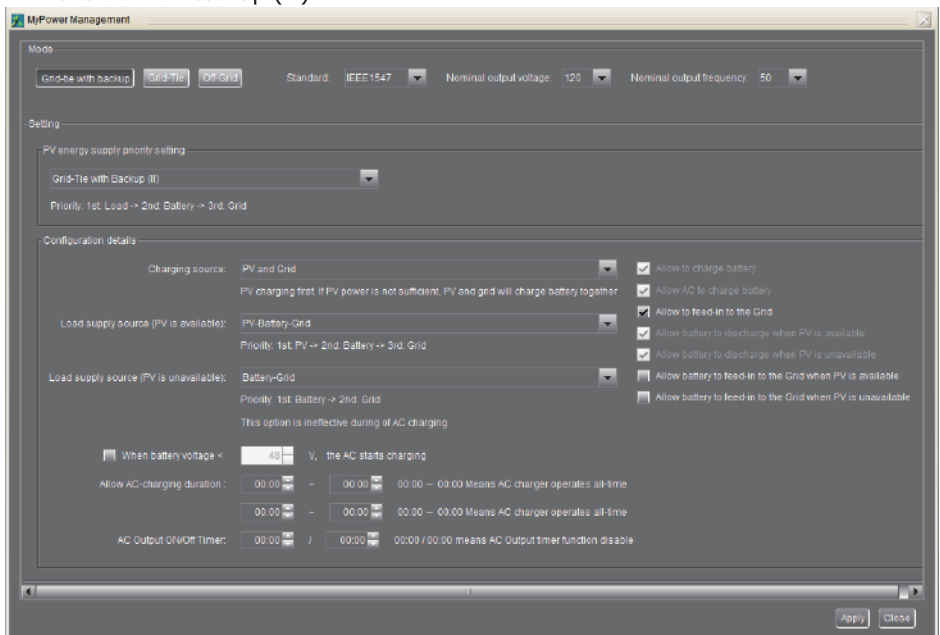

PV energy supply priority setting: 1st Load, 2nd Battery and 3rd Grid.

PV power will provide power to the load first. Then, it will charge battery. If there is any remaining power left, it will feed-in to the grid.

Battery charging source:

1. PV and Grid

It's allowed to charge battery from PV power first. If it's not sufficient, grid will charge battery.

2. PV only

It is only allow PV power to charge battery.

3. None

It is not allowed to charge battery no matter it's PV power or grid.

Load supply source:

When PV power is available:

1. 1st PV, 2nd Battery, 3rd Grid

PV power will provide power to the load first. If it's not sufficient, battery power will provide power to the load. When battery power is running out or not available, grid will back up the load.

NOTE: This option will become ineffective during AC charging time and the priority will automatically become 1st PV, 2nd Grid and 3rd Battery in order. Otherwise, it will cause battery damage.

2. 1st PV, 2nd Grid, 3rd Battery

PV power will provide power to the load first. If it's not sufficient, grid will provide power to the load. If grid is not available at the same time, battery power will back up.

When PV power is not available:

1. 1st Grid, 2nd Battery: Grid will provide power to the load at first. If grid is not available, battery power will provide power backup.
2. 1st Battery, 2nd Grid: Battery power will provide power to the load at first. If battery power is running out, grid will back up the load

NOTE: This option will become ineffective during AC charging time and the priority will automatically become 1st Grid and 2nd Battery order. Otherwise, it will cause battery damage.

● Grid-tie with backup (III):

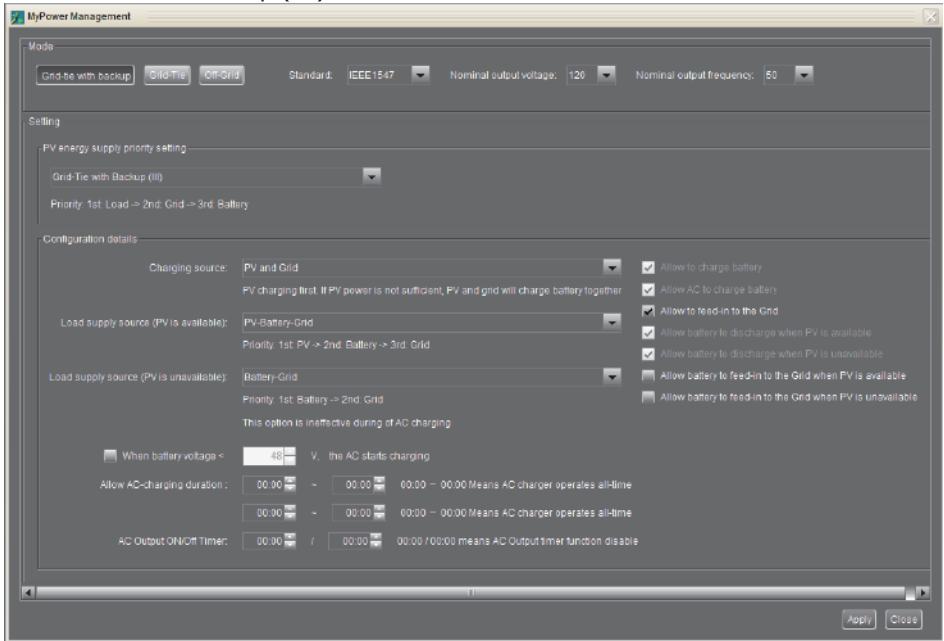

PV energy supply priority setting: 1st Load, 2nd Grid and 3rd Battery

PV power will provide power to the load first. If there is more PV power available, it will feed-in to the grid. If feed-in power reaches max. feed-in power setting, the remaining power will charge battery.

NOTE: The max. feed-in grid power setting is available in parameter setting. Please refer to software manual.

Battery charging source:

1. PV and Grid: It's allowed to charge battery from PV power first. If it's not sufficient, grid will charge battery.
2. PV only: It is only allow PV power to charge battery.
3. None: It is not allowed to charge battery no matter it's PV power or grid.

Load supply source:

When PV power is available:

1. 1st PV, 2nd Battery, 3rd Grid

PV power will provide power to the load first. If it's not sufficient, battery power will provide power to the load. When battery power is running out or not available, grid will back up the load.

NOTE: This option will become ineffective during AC charging time and the priority will automatically become 1st PV, 2nd Grid and 3rd Battery in order. Otherwise, it will cause battery damage.

2. 1st PV, 2nd Grid, 3rd Battery

PV power will provide power to the load first. If it's not sufficient, grid will provide power to the load. If grid is not available at the same time, battery power will back up.

When PV power is not available:

- 1st Grid, 2nd Battery: Grid will provide power to the load at first. If grid is not available, battery power will provide power backup.
- 1st Battery, 2nd Grid: Battery power will provide power to the load at first. If battery power is running out, grid will back up the load.

NOTE: This option will become ineffective during AC charging time and the priority will automatically become 1st Grid and 2nd Battery order. Otherwise, it will cause battery damage.

- Grid-tie with backup (IV): Users are only allowed to set up peak time and off-peak electricity demand.

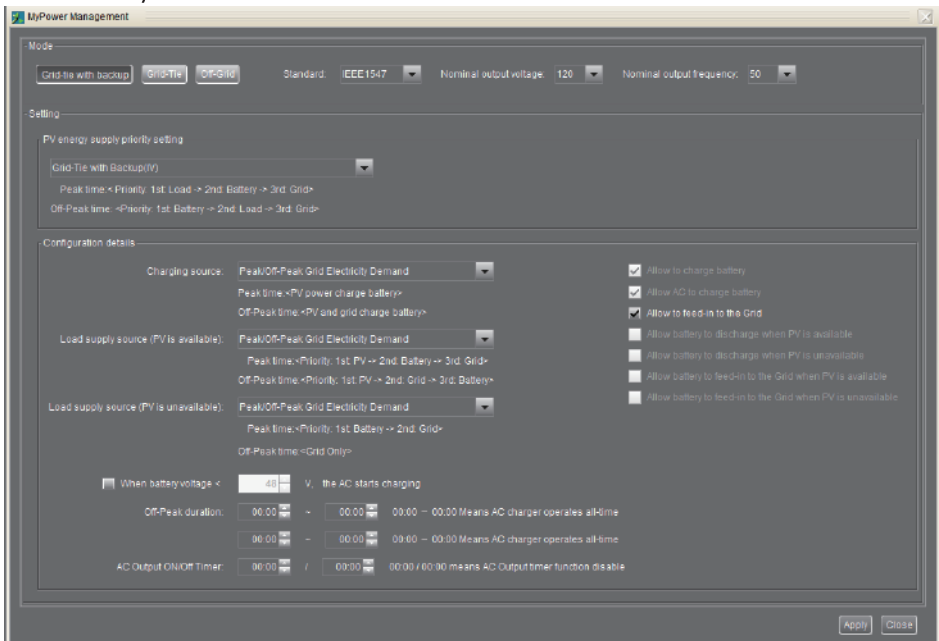

Working logic under peak time:

PV energy supply priority: 1st Load, 2nd Battery and 3rd Grid

PV power will provide power to the load first. If PV power is sufficient, it will charge battery next. If there is remaining PV power left, it will feed-in to the grid. Feed-in to the grid is default disabled.

Battery charging source: PV only

Only after PV power fully supports the load, the remaining PV power is allowed to charge

battery during peak time.

Load supply source: 1st PV, 2nd Battery, 3rd Grid

PV power will provide power to the load first. If PV power is not sufficient, battery power will back up the load. If battery power is not available, grid will provide the load. When PV power is not available, battery power will supply the load first. If battery power is running out, grid will back up the load.

Working logic under off-peak time:

PV energy supply priority: 1st Battery, 2nd Load and 3rd Grid

PV power will charge battery first. If PV power is sufficient, it will provide power to the loads. The remaining PV power will feed to the grid.

NOTE: The max. feed-in grid power setting is available in parameter setting. Please refer to software manual.

Battery charging source: PV and grid charge battery

PV power will charge battery first during off-peak time. If it's not sufficient, grid will charge battery.

Load supply source: 1st PV, 2nd Grid, 3rd Battery

When battery is fully charged, remaining PV power will provide power to the load first. If PV power is not sufficient, grid will back up the load. If grid power is not available, battery power will provide power to the load.

Grid-Tie

Under this operation mode, PV power only feeds-in to the grid. No priority setting is available.

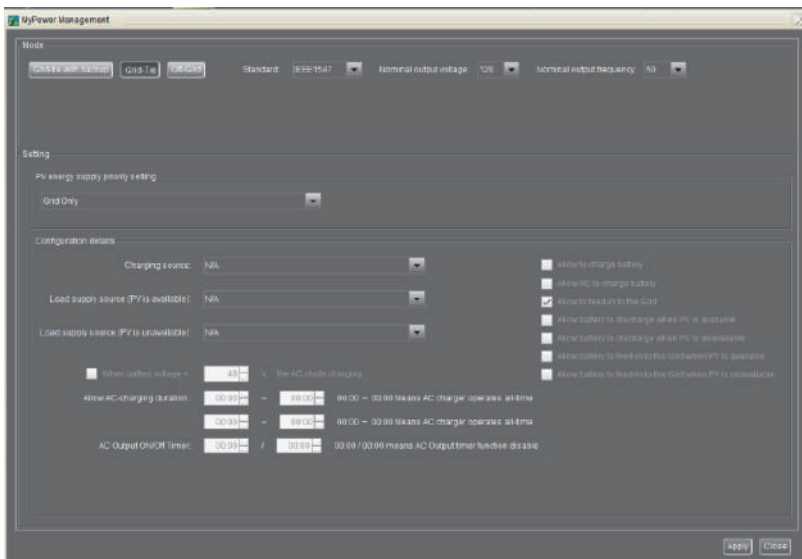

Off-Grid

- Off-Grid (I): Default setting for off-grid mode.

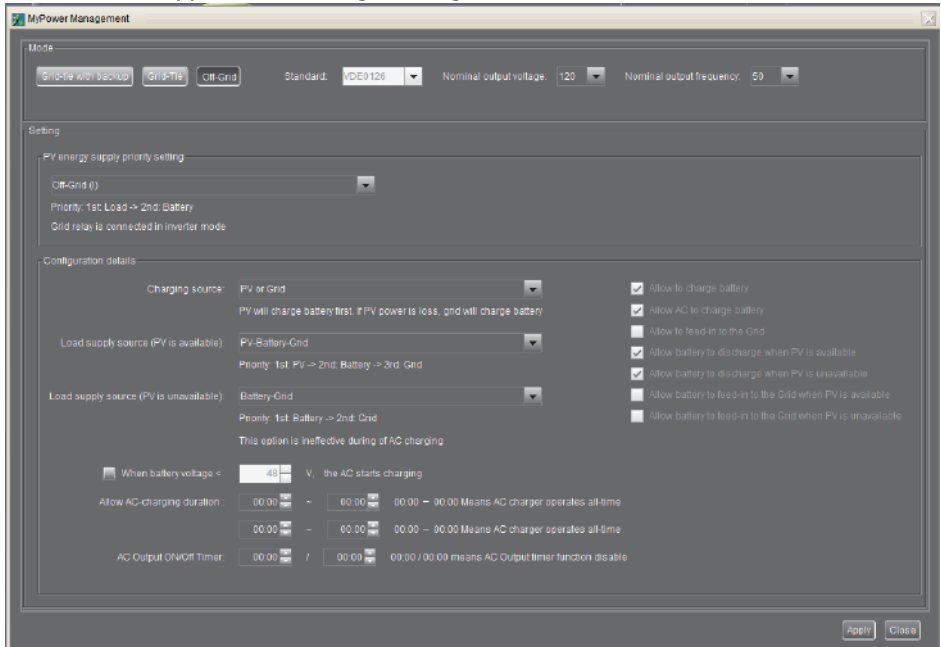

PV energy supply priority setting: 1st Load, 2nd Battery

PV power will provide power to the load first and then charge battery. Feed-in to the grid is not allowed under this mode. At the same time, the grid relay is connected in Inverter mode. That means the transfer time from inverter mode to battery mode will be less than 15ms. Besides, it will avoid overload fault because grid can supply load when connected load is over rated output capacity of the inverter.

Battery charging source:

1. PV or Grid: If there is remaining PV power after supporting the loads, it will charge battery first. Only until PV power is not available, grid will charge battery. (Default)
2. PV only: It is only allow PV power to charge battery.
3. None: It is not allowed to charge battery no matter it's PV power or grid.

Load supply source:

When PV power is available:

1. 1st PV, 2nd Battery, 3rd Grid (Default)
PV power will provide power to the load first. If it's not sufficient, battery power will provide power to the load. When battery power is running out or not available, grid will back up the load.
2. 1st PV, 2nd Grid, 3rd Battery
PV power will provide power to the load first. If it's not sufficient, grid will provide power to the load. If grid is not available at the same time, battery power will back up.

When PV power is not available:

1. 1st Grid, 2nd Battery

Grid will provide power to the load at first. If grid is not available, battery power will provide power backup.

2. 1st Battery, 2nd Grid (Default)

Battery power will provide power to the load at first. If battery power is running out, grid will back up the load.

NOTE: This option will become ineffective during AC charging time and the priority will automatically become 1st Grid and 2nd Battery order. Otherwise, it will cause battery damage.

● Off-Grid (II)

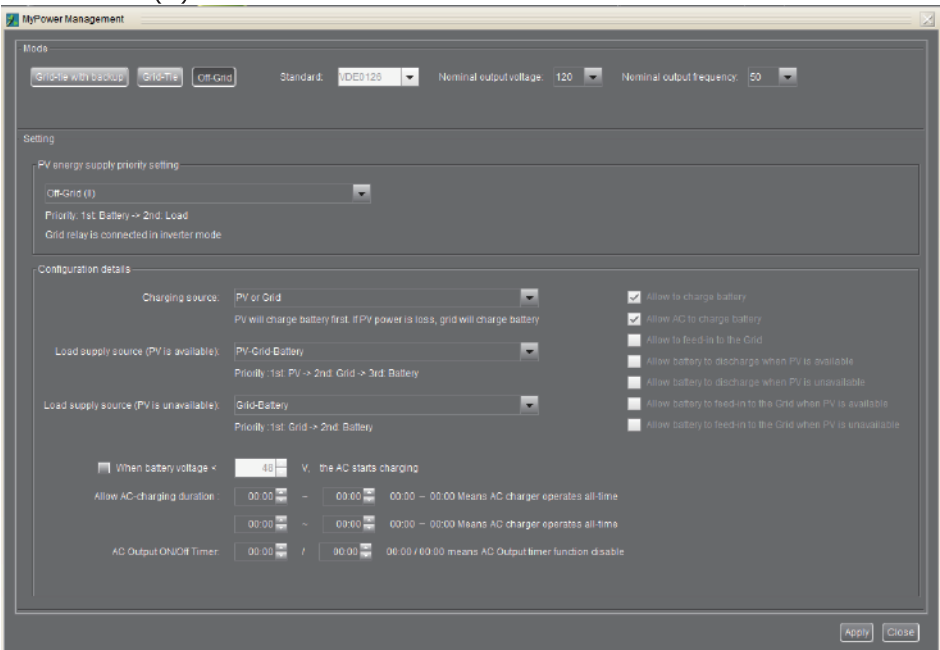

PV energy supply priority setting: 1st Battery, 2nd Load

PV power will charge battery first. After battery is fully charged, if there is remaining PV power left, it will provide power to the load. Feed-in to the grid is not allowed under this mode. At the same time, the grid relay is connected in Inverter mode. That means the transfer time from inverter mode to battery mode will be less than 15ms. Besides, it will avoid overload fault because grid can supply load when connected load is over rated output capacity of the inverter.

Battery charging source:

1. PV or Grid: If there is remaining PV power after supporting the loads, it will charge battery first. Only until PV power is not available, grid will charge battery.
2. PV only: It is only allow PV power to charge battery.
3. None: It is not allowed to charge battery no matter it's PV power or grid.

NOTE: It's allowed to set up AC charging duration.

Load supply source:

When PV power is available: 1st PV, 2nd Grid, 3rd Battery

PV power will provide power to the load first. If it's not sufficient, grid will provide power to the load. If grid is not available at the same time, battery power will back up.

When PV power is not available:

1. 1st Grid, 2nd Battery: Grid will provide power to the load at first. If grid is not available, battery power will provide power backup.
2. 1st Battery, 2nd Grid: Battery power will provide power to the load at first. If battery power is running out, grid will back up the load.

NOTE: This option will become ineffective during AC charging time and the priority will automatically become 1st Grid and 2nd Battery order. Otherwise, it will cause battery damage.

● Off-Grid (III)

The screenshot shows the 'MyPower Management' software interface. The 'Mode' section is set to 'Off-Grid'. The 'Setting' section shows 'PV energy supply priority setting' set to 'Off-Grid (III)' with a priority of '1st Load -> 2nd Battery'. The 'Configuration details' section shows 'Charging source' set to 'PV or Grid' and 'Load supply source (PV is available)' set to 'PV-Battery-Grid'. The 'AC Output ON/Off Timer' is set to '00:00 / 00:00'. The 'When battery voltage < 48 V, the AC starts charging' checkbox is checked. The 'Allow AC to charge battery' checkbox is checked. The 'Allow battery to discharge when PV is available' checkbox is checked. The 'Allow battery to feed-in to the Grid when PV is available' checkbox is checked. The 'Allow battery to feed-in to the Grid when PV is unavailable' checkbox is checked.

PV energy supply priority setting: 1st Load, 2nd Battery

PV power will provide power to load first and then charge battery. Feed-in to the grid is not allowed under this mode. The grid relay is NOT connected in Inverter mode. That means the transfer time from inverter mode to battery mode will be about 15ms. If connected load is over rated output capacity of the inverter and grid is available, this inverter will allow grid to provide power to the loads and PV power to charge battery. Otherwise, this inverter will activate fault protection.

Battery charging source:

1. PV or Grid: If there is remaining PV power after supporting the loads, it will charge battery first. Only until PV power is not available, grid will charge battery.
2. PV only: It is only allow PV power to charge battery.
3. None: It is not allowed to charge battery no matter it's PV power or grid.
NOTE: It's allowed to set up AC charging duration.

Load supply source:

When PV power is available: 1st PV, 2nd Battery, 3rd Grid

PV power will provide power to the load first. If it's not sufficient, battery power will back up the load. Only after battery power is running, Grid will back up the load.

When PV power is not available:

1. 1st Grid, 2nd Battery: Grid will provide power to the load at first. If grid is not available, battery power will provide power backup.
2. 1st Battery, 2nd Grid: Battery power will provide power to the load at first. If battery power is running out, grid will back up the load.

NOTE: This option will become ineffective during AC charging time and the priority will automatically become 1st Grid and 2nd Battery order. Otherwise, it will cause battery damage.

13. Operation

13-1. Interface



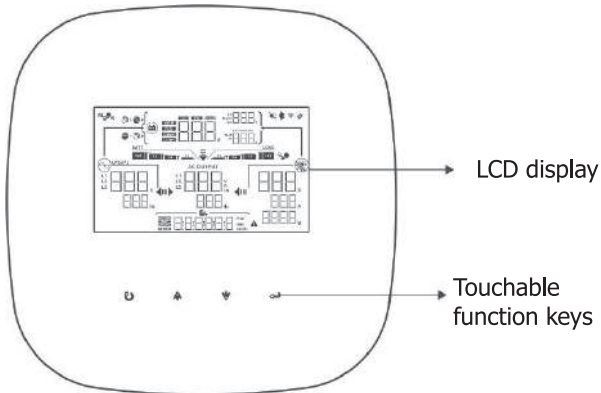





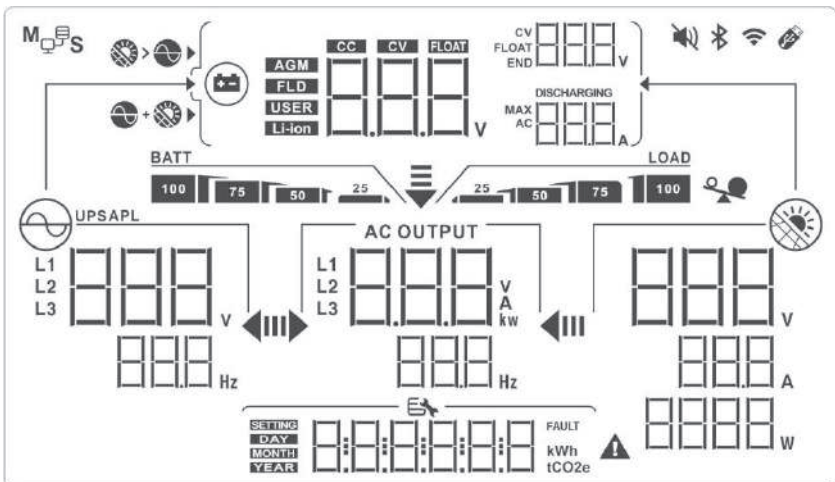

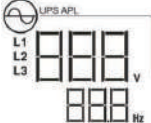
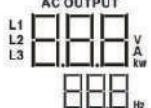
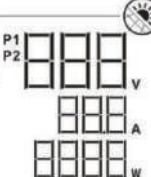

The operation LCD panel, shown in the chart below, includes four touchable function keys and a LCD display to indicate the operating status and input/output power information.



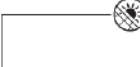

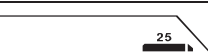

NOTICE: To accurately monitor and calculate the energy generation, please calibrate the timer of this unit via software every one month. For the detailed calibration, please check the user manual of bundled software.





13-2. LCD Information Define



Display	Function
	<p>Indicates AC input voltage and frequency. V: voltage, Hz: frequency, L1/L2/L3: Line phase</p>
	<p>Indicates AC output power, voltage, frequency, or current. kw: active power, V: voltage, Hz: frequency, A: current L1/L2/L3: AC output phase</p>
	<p>Indicates PV input voltage, power or current. V: voltage, W: power, P1: PV input 1, P2: PV input 2 A: current</p>
	<p>Allow AC and PV charging</p>
	<p>Only PV charging is allowed</p>
	<p>Indicates battery voltage, battery current, charging status or battery parameters V: voltage, A: current, Li-ion: Lithium-ion battery type</p>
	<p>Indicates battery level in battery mode.</p>
	<p>Indicates the warning and fault codes.</p>
	<p>Indicates date and time or the date and time users set for querying energy generation.</p>
	<p>Indicates solar panels. Icon flashing indicates PV input voltage is out of range.</p>
	<p>Indicates utility. Icon flashing indicates utility voltage or frequency is out of range.</p>
	<p>Indicates battery condition. And the lattice of the icon indicates battery capacity.</p>
	<p>Icon  flashing indicates battery is not allowed to discharge.</p>
	<p>Icon  flashing indicates the battery voltage is too low.</p>

	<p>Indicates AC output for loads is enabled and inverter is providing power to the connected loads.</p>
	<p>This icon lighting indicates SW button is on and AC output is turned on. This icon flashing indicates SW button is off but there is AC output. NOTICE: Be careful to take notice of this icon status. If SW button is off with this icon flashing, inverter will not provide backup power to AC output while AC power failure occurs at the same time.</p>
	<p>Indicates overload.</p>
	<p>Indicates parallel operation is working.</p>

13-3. Touchable function keys

Function Key		Operation	Function
	Enter	Quick touch.	To confirm/enter the selection in setting mode
	ESC	Quick touch.	Exit the setting.
	Up	Quick touch.	Select last selection or increase value.
	Down	Quick touch.	<p>If it's in query menu, press this button to jump to next selection or decrease value. Mute alarm in standby mode or battery mode.</p>

NOTE: If backlight shuts off, you may activate it by touching any button.

13-4.SW ON/OFF Operation (located on the side of the inverter)



- Quick press to wake up inverter when the input power is supplied from battery only.
- Press and hold the buttons for 3 seconds to turn on or off the AC output of the inverter.

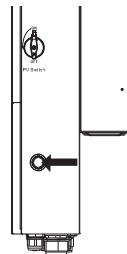

NOTICE: Be careful to take notice of "AC OUTPUT" icon status. If SW button is off with this icon flashing, inverter will not provide backup power to AC output while AC power failure occurs at the same time.



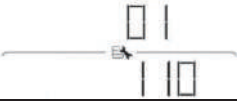
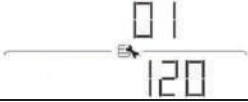

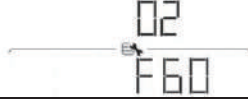
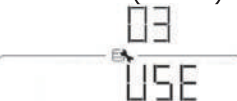
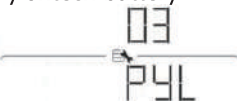
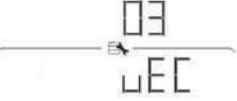
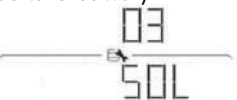

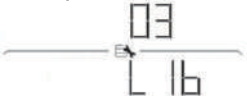
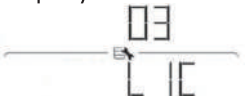
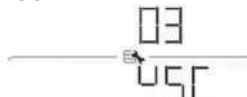
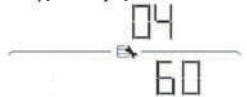

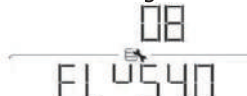

13-5. LCD Setting

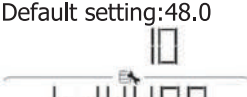
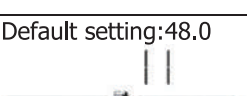
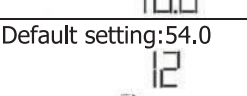
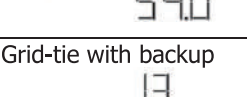
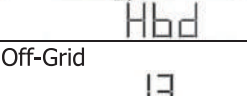
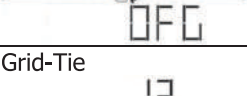



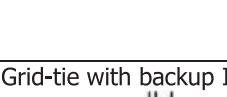

After touching and holding "Enter" button for 2 seconds, the unit will enter setting mode. Press "UP" or "DOWN" button to select setting programs. And then, press "ENTER" button to confirm the selection or ESC button to exit.

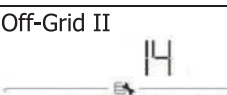

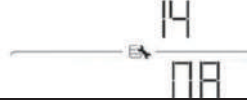
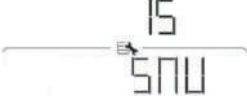
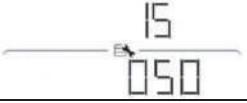

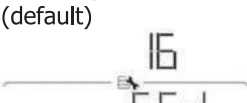
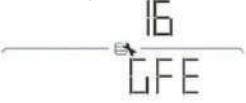
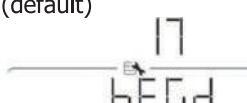
Prog ram	Description	Selectable option	
00	Exit setting mode	Escape 	
01	Output voltage	110Vac 	120Vac(default) 
02	Output frequency	50Hz 	60Hz(default) 
03	Battery type	User-Defined(default) 	If "User Defined" is selected, battery charge voltage and low DC cut off voltage can be set up in program 4, 7, 8 and 9.
		Pylontech battery 	If selected, programs of 4, 7, 8 and 9 will be automatically set up. No need for further setting.
		WECO battery 	If selected, programs of 4, 7, 8 and 9 will be auto-configured per battery supplier recommended. No need for further adjustment.
		Soltaro battery 	If selected, programs of 4, 7, 8 and 9 will be automatically set up. No need for further setting.

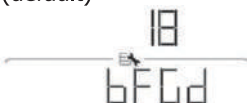



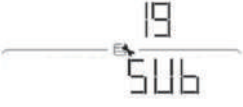
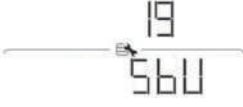

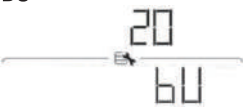
03	Battery type	LiB-protocol compatible battery 	Select "LiB" if using Lithium battery compatible to LiB protocol. If selected, programs of 4, 7, 8 and 9 will be automatically set up. No need for further setting.
		3 rd party Lithium battery 	If selected, programs of 4, 7, 8 and 9 will be automatically set up. No need for further setting. Please contact the battery supplier for installation procedure.
		VSC 	If selected, standard CAN protocol will be supported.
04	Maximum charging current: To configure total charging current for solar and utility chargers. (Max. charging current = utility charging current + solar charging current)	60A(default) 	Setting range is 1A, then from 10A to 200A. Increment of each click is 10A.
05	Maximum utility charging current	60A(default) 	Setting range is from 10A to 200A. Increment of each click is 10A.
06	Maximum discharging current	200A(default) 	Setting range is from 10A to 200A. Increment of each click is 10A.

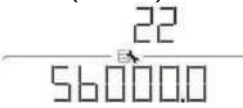
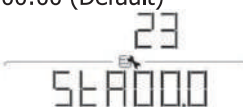

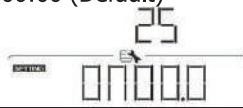

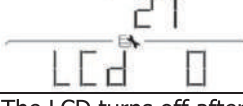
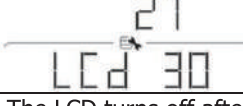
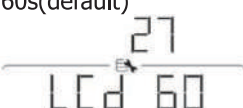

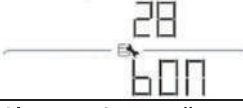
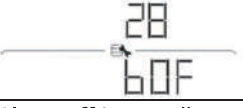
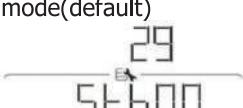
07	Bulk charging voltage (C.V voltage)	Default setting: 56.0V 	Setting range is from 48.0V to 60.0V. Increment of each click is 0.1V.
08	Floating charging voltage	Default setting: 54.0V 	Setting range is from 48.0V to 60.0V. Increment of each click is 0.1V.
09	Low DC cut off battery voltage setting when grid is unavailable	Default setting:42.0 	Setting range is from 40V to 60V. Increment of each click is 0.1V.
10	Battery re-discharging voltage when grid is unavailable	Default setting:48.0 	Setting range is form 40V to 60V. Increment of each click is 0.1V
11	Low DC cut off battery voltage when grid is available	Default setting:48.0 	Setting range is from 42V to 60V voltage. Increment of each click is 0.1V
12	Battery re-discharging voltage when grid is available	Default setting:54.0 	Setting range is from 42V to 60V voltage. Increment of each click is 0.1V
13	Operation Mode	Grid-tie with backup 	PV power can feed-in back to grid, provide power to the load and charge battery.
		Off-Grid 	PV power only provides power to the load and charge battery. No feed-in back to grid is allowed.
		Grid-Tie 	PV power only can feed-in back to grid.

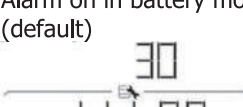
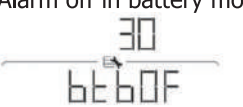

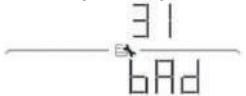
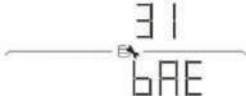

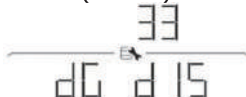
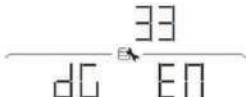
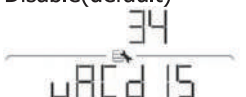
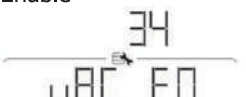
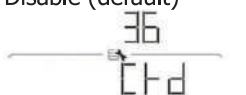
14	PV energy supply priority setting	Grid-tie with backup Mode	
		Grid-tie with backup I 	Battery-Load-Grid: PV power will charge battery first, then provide power to the load. If there is any remaining power left, it will feed-in to the grid.
		Grid-tie with backup II 	Load-Battery-Grid: PV power will provide power to the load first. Then, it will charge battery. If there is any remaining power left, it will feed-in to the grid.
		Grid-tie with backup III 	Load-Grid-Battery: PV power will provide power to the load first. If there is more PV power available, it will feed-in to the grid. If feed-in power reaches max. feed-in power setting, the remaining power will charge battery.
		Grid-tie with backup IV 	If selected, it is only allowed to set up peak time and off-peak for electricity demand. Programs of 15, 17, 18, 19 and 20 can't be set and only programs of 21, 22, 23 and 24 can be set.
		Off-Grid Mode	
		Off-Grid I 	Load-Battery: PV power will provide power to the load first and then charge battery. Feed-in to the grid is not allowed under this mode. At the same time, the grid relay is
		Off-Grid II 	Battery-Load: PV power will charge battery first. After battery is fully charged, if there is remaining PV power left, it will provide power to the load. Feed-in to the grid is not allowed under this mode. At the same time, the grid relay is connected.

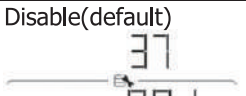
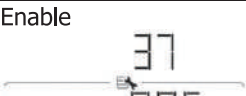
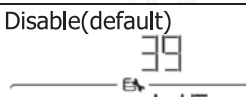
14	PV energy supply priority setting	Off-Grid III 	Load-Battery: PV power will provide power to load first and then charge battery. Feed-in to the grid is not allowed under this mode. The grid relay is NOT connected.
		Grid-Tie Mode 	PV power only feeds-in to the grid. No priority setting is available.
15	Charger source priority	Solar and Utility(default) 	If there is remaining PV power after supporting the loads, it will charge battery first. Only until PV power is not available,grid will charge battery.
		Only Solar 	It is only allow PV power to charge battery.
		None 	It is not allowed to charge battery no matter it's PV power or grid.
16	Feed to grid function	Feed to grid disable (default) 	Feed to grid enable 
17	Battery energy feed to grid function when PV energy is available	Battery feed to grid disable (default) 	Battery feed to grid enable 
18	Battery energy feed to grid function when PV energy is unavailable.	Battery feed to grid disable (default) 	Feed to grid enable 

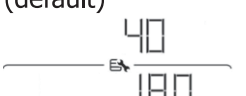
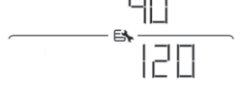
19	Load supply source (PV is available)	SUB(default) 	Solar-grid-battery: PV power will provide power to the load first. If it's not sufficient, grid will provide power to the load. If grid is not available at the same time, battery power will back up.
		SBU 	Solar-Battery-Grid: PV power will provide power to the load first. If it's not sufficient, battery power will provide power to the load. When battery power is running out or not available, grid will back up the load.
20	Load supply source (PV is unavailable)	UB(default) 	Grid-Battery: Grid will provide power to the load at first. If grid is not available, battery power will provide power backup.
		BU 	Battery-Grid: Battery power will provide power to the load at first. If battery power is running out, grid will back up the load. This setting is ineffective during of AC charging.
21	Start charging time for first duration of AC charge	00:00 (Default) 	The setting range of start charging time for AC charger is from 00:00 to 23:00. Increment of each click is 1 hour.
22	Stop charging time for first duration of AC charge	00:00 (Default) 	The setting range of stop charging time for AC charger is from 00:00 to 23:00. Increment of each click is 1 hour.
23	Start charging time for second duration of AC charge	00:00 (Default) 	The setting range of start charging time for AC charger is from 00:00 to 23:00. Increment of each click is 1 hour.

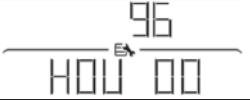
24	Stop charging time for second duration of AC charge	00:00 (Default) 	The setting range of start charging time for AC charger is from 00:00 to 23:00. Increment of each click is 1 hour.
25	Scheduled time for AC output on	00:00 (Default) 	The setting range of AC output on is from 00:00 to 23:00. Increment of each click is 1 hour.
26	Scheduled time for AC output off	00:00 (Default) 	The setting range of AC output off is from 00:00 to 23:00. Increment of each click is 1 hour.
27	LCD off waiting time	LCD is always on 	The LCD turns off after 30s 
		The LCD turns off after 60s(default) 	The LCD turns off after 300s. 
		The LCD turns off after 600s 	
28	Alarm control	Alarm on(default) 	Alarm off 
29	Alarm control at standby mode	Alarm on in standby mode(default) 	Alarm off in standby mode 
30	Alarm control at battery mode	Alarm on in battery mode (default) 	Alarm off in battery mode 

31	Activate lithium battery when the device is powered on	Activate lithium battery disable(default) 	Activate lithium battery enable 
32	AC output mode	Single: This inverter is used in single phase application (default) 	Parallel: This inverter is operated in parallel system. 
33	Generator as AC source	Disable(default) 	Enable 
34	Wide AC input range	Disable(default) 	Enable 
36	External CT function (Refer to Appendix III for the details)	Disable (default) 	Enable 
37	PV parallel	Disable(default) 	Enable 
39	Generator port function (Refer to Appendix IV for the details)	Disable(default) 	If selected, the input/output of generator port will be disabled.
		Enable 	If selected, genertor port will be activated. However, this port will not function in parallel mode.
40	Phase difference	180° phase difference (default) 	120° phase difference 

95	Time setting – Minute		For minute setting, the range is from 00 to 59.
96	Time setting – Hour		For hour setting, the range is from 00 to 23.
97	Time setting–Day		For day setting, the range is from 00 to 31.
98	Time setting–Month		For month setting, the range is from 01 to 12.
99	Time setting – Year		For year setting, the range is from 17 to 99.

13-6. Query Menu Operation

The display shows current contents that have been set. The displayed contents can be changed in query menu via button operation. Press 'Enter' button to enter query menu. There are seven query selections:

- Input voltage or frequency of AC input.
- Frequency, voltage, power or load percentage of AC output.
- Input voltage or power of PV input.
- Battery voltage or capability percentage.

Setting Display Procedure

- **Input voltage or frequency of AC input**

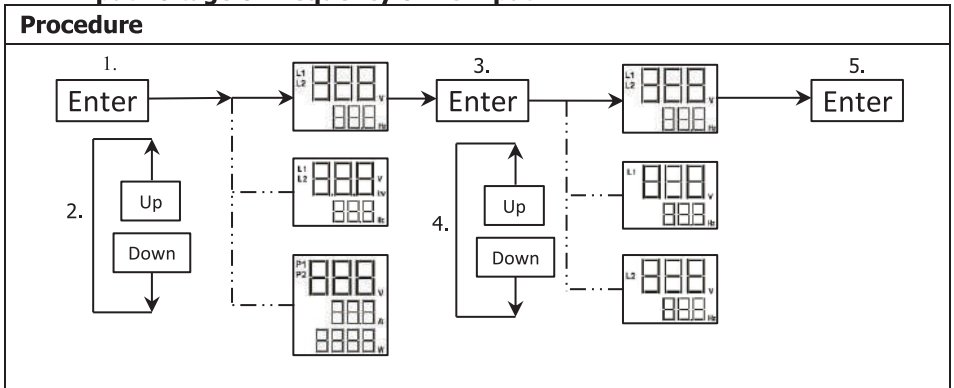

● **Frequency, voltage, power or percentage of AC output**

Procedure

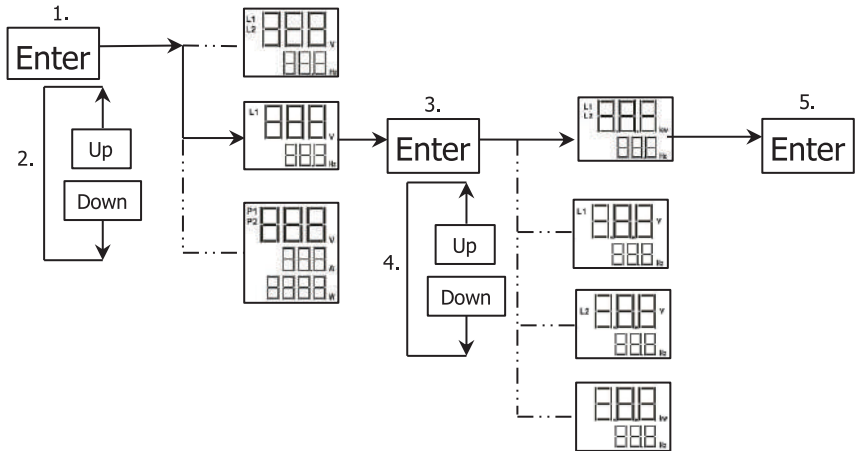

● **Input voltage or power of PV input.**

Procedure

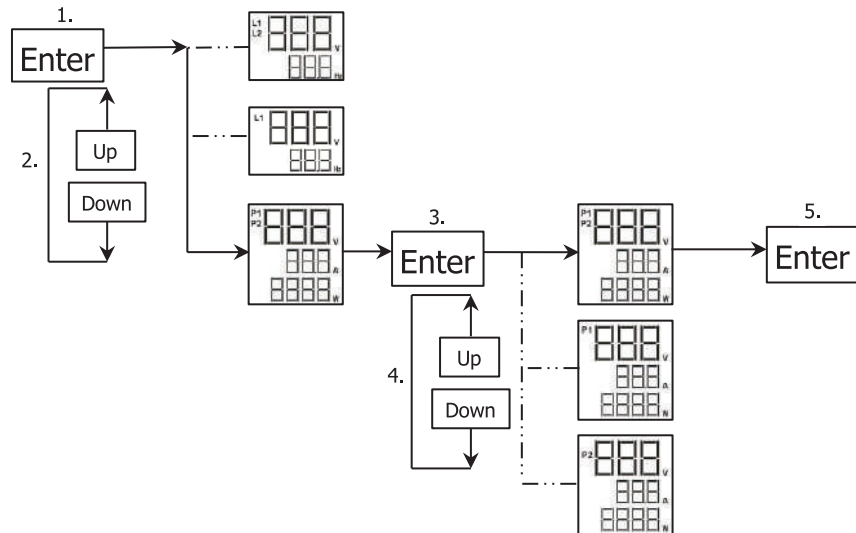

Switch LCD Displayed Information

The LCD display information will be switched in turns by pressing "▲" or "▼" key. The selectable information is switched as the following table in order.

Selectable information	LCD display
Real date	<p>Real date: 2020-08-18</p>
Real time	<p>Real time: 10:08</p>
PV energy generated today.	<p>PV energy generated this month =8Wh.</p>

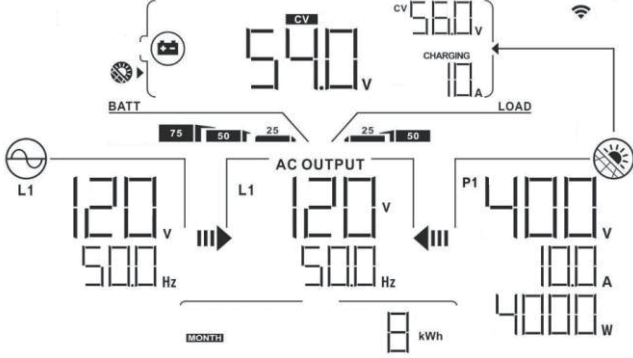
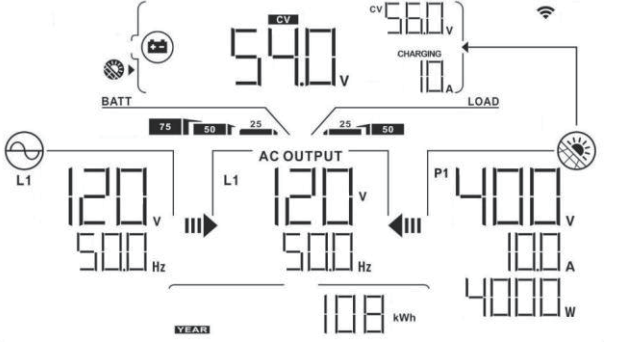
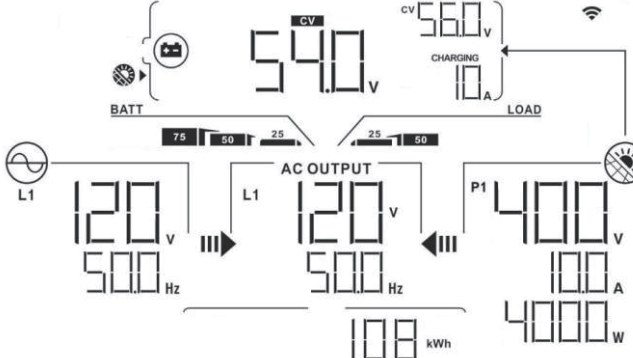
<p>PV energy generated this month.</p>	<p>PV energy generated this month = 8kWh.</p> 
<p>PV energy generated this year.</p>	<p>PV energy generated this year = 108kWh</p> 
<p>PV energy generated totally.</p>	<p>Total PV energy generation = 108kWh.</p> 

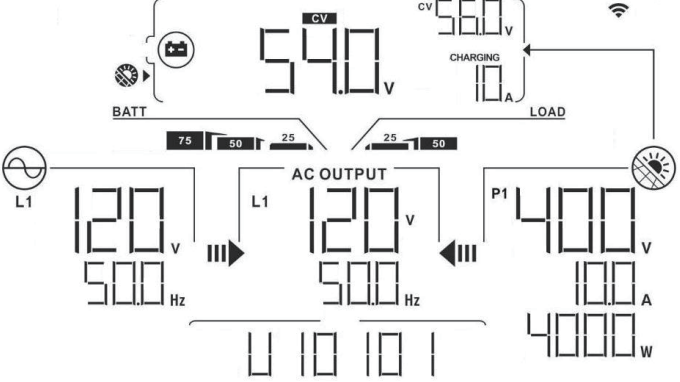
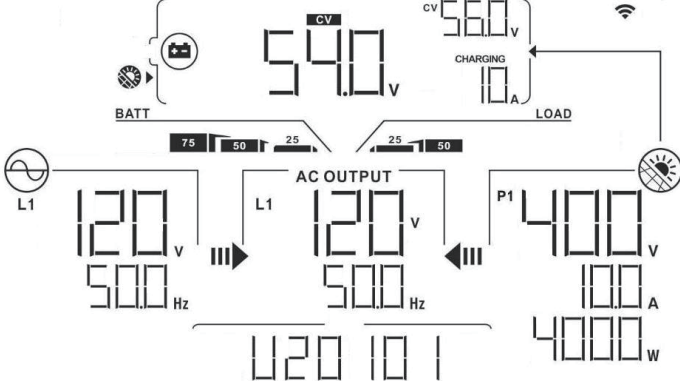
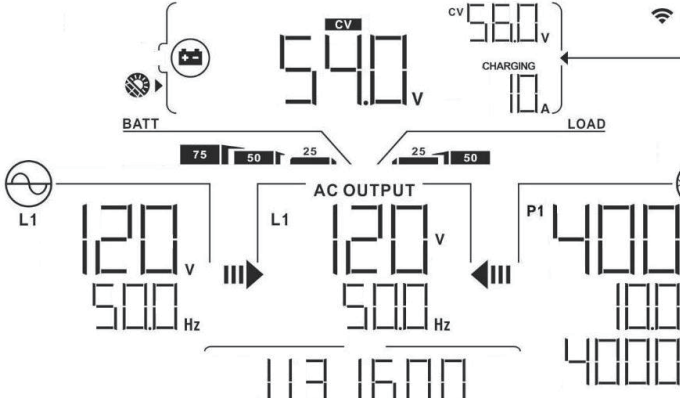
<p>Main CPU version checking.</p>	<p>Main CPU version 01.01.</p>  <p>The diagram shows a digital display for the Main CPU version 01.01. At the top, it displays 'CV 540 V' and 'CV 560 V'. Below this, there are indicators for 'BATT' (battery), 'CHARGING 10 A', and 'LOAD'. A central bar shows '75 50 25' on the left and '25 50' on the right. The 'AC OUTPUT' section shows two '120 V 500 Hz' outputs and a 'P1 4000 W' output. The bottom of the display shows 'U 10 10 1' and '4000 W'.</p>
<p>Secondary CPU version checking.</p>	<p>Secondary CPU version 01.01.</p>  <p>The diagram shows a digital display for the Secondary CPU version 01.01. It features the same top indicators as the Main CPU: 'CV 540 V', 'CV 560 V', 'BATT', 'CHARGING 10 A', and 'LOAD'. The central bar is identical. The 'AC OUTPUT' section shows two '120 V 500 Hz' outputs and a 'P1 4000 W' output. The bottom of the display shows 'U 20 10 1' and '4000 W'.</p>
<p>Remote panel version checking.</p>	<p>Remote panel version 16.00</p>  <p>The diagram shows a digital display for the Remote panel version 16.00. It features the same top indicators as the other two: 'CV 540 V', 'CV 560 V', 'BATT', 'CHARGING 10 A', and 'LOAD'. The central bar is identical. The 'AC OUTPUT' section shows two '120 V 500 Hz' outputs and a 'P1 4000 W' output. The bottom of the display shows 'U 3 16 00' and '4000 W'.</p>

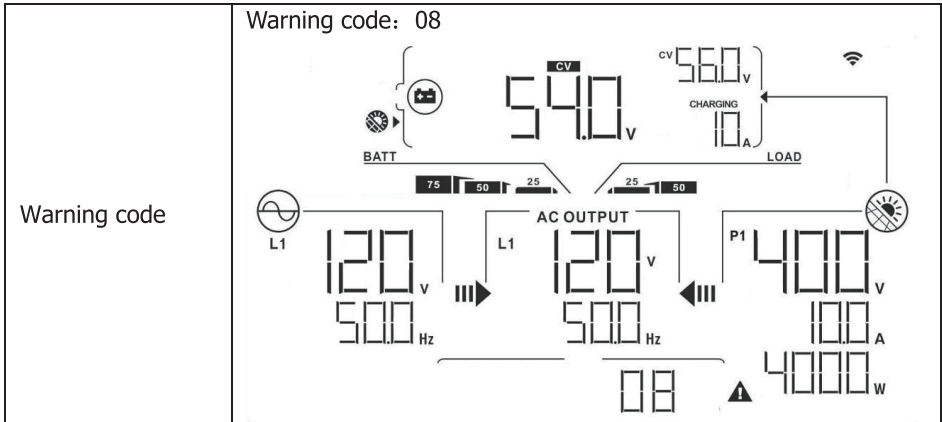

13-7. Operation Mode & Display

Below is only contained LCD display for **grid-tie with backup mode (I)**. If you need to know other operation mode with LCD display, please check with installer.

Inverter mode with grid connected

This inverter is connected to grid and working with DC/INV operation.

LCD Display	Description
	<p>PV power is sufficient to charge battery, provide power to loads, and then feed in to the grid.</p>
	<p>PV power is sufficient to charge the battery first. However, remaining PV power is not sufficient to back up the load. Therefore, remaining PV power and the utility are supplying power to the connected load.</p>

	<p>PV power is generated, but not sufficient enough to charge battery by itself. PV power and the utility are charging battery at the same time. And the utility is also supplying power to the connected load.</p>
	<p>PV power is sufficient to provide power to loads and feed power back to the grid.</p>
	<p>PV power and utility are providing power to the connected loads because of insufficient PV power.</p>
	<p>Only utility is charging battery and providing power to connected loads.</p>

Inverter mode without grid connected

This inverter is working with DC/INV operation and not connecting to the grid.

LCD Display	Description
	<p>PV power is sufficient to charge battery and provide power to the connected loads.</p>

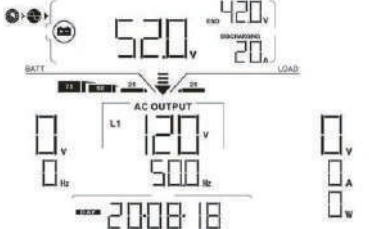
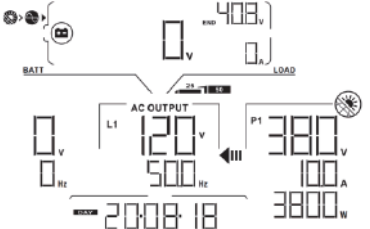
	<p>PV power is generated, but not sufficient to power loads by itself. PV power and battery are providing power to the connected loads at the same time.</p>
	<p>Only battery power is available to provide power to connected loads.</p>
	<p>Only PV power supplies power to connected loads. Notice: The inverter doesn't support battery hot pluggable. When the inverter is working with solar input, turn off the inverter first and then connect the battery.</p>

Bypass mode

The inverter is working without DC/INV operation and connecting to the loads.

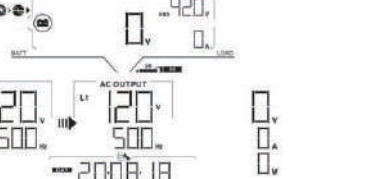
LCD Display	Description
	<p>Only utility is available to provide power to connected loads.</p>

Standby mode :

The inverter is working without DC/INV operation and load connected.

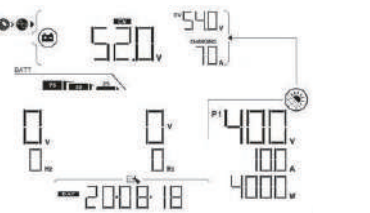
LCD Display	Description
	<p>This inverter is disabled on AC output or even AC power output is enabled, but an error occurs on AC output. Only PV power is sufficient to charge battery.</p>

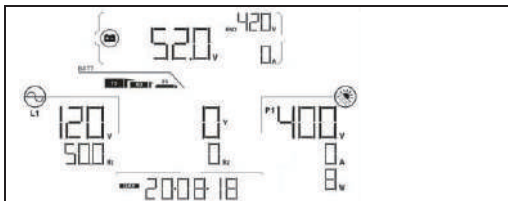

If PV, battery or utility icons are flashing, it means they are not within acceptable working range. If they are not displayed, it means they are not detected.

15. Charging Management

Charging Parameter	Default Value	Note
Charging current	60A	It can be adjusted via software from 5Amp to 200Amp.
Floating charging voltage (default)	54.0 Vdc	It can be adjusted via software from 50Vac to 62Vdc.
Max. absorption charging voltage (default)	56.0 Vdc	It can be adjusted via software from 50Vac to 62Vdc.
Battery overcharge protection	64.0 Vdc	

Charging process based on default setting.

3 stages:

First – max. charging voltage increases to 56V;

Second- charging voltage will maintain at 56V until charging current is down to 12 Amp;

Third- go to floating charging at 54V.

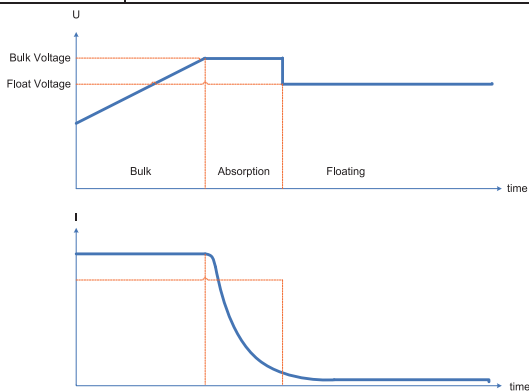

This inverter can connect to battery types of sealed lead acid battery, vented battery, gel battery and lithium battery. The detail installation and maintenance explanations of the external battery pack are provided in the manufacturer's external battery pack of manual.

If using sealed lead acid battery, please set up the max. charging current according to below formula:

$$\text{The maximum charging current} = \text{Battery capacity (Ah)} \times 0.2$$

For example, if you are using 300 Ah battery, then, maximum charging current is $300 \times 0.2 = 60$ (A). Please use at least 50Ah battery because the settable minimum value of charging current is 10A. If using AGM/Gel or other types of battery, please consult with

installer for the details.

Below is setting screen from software:

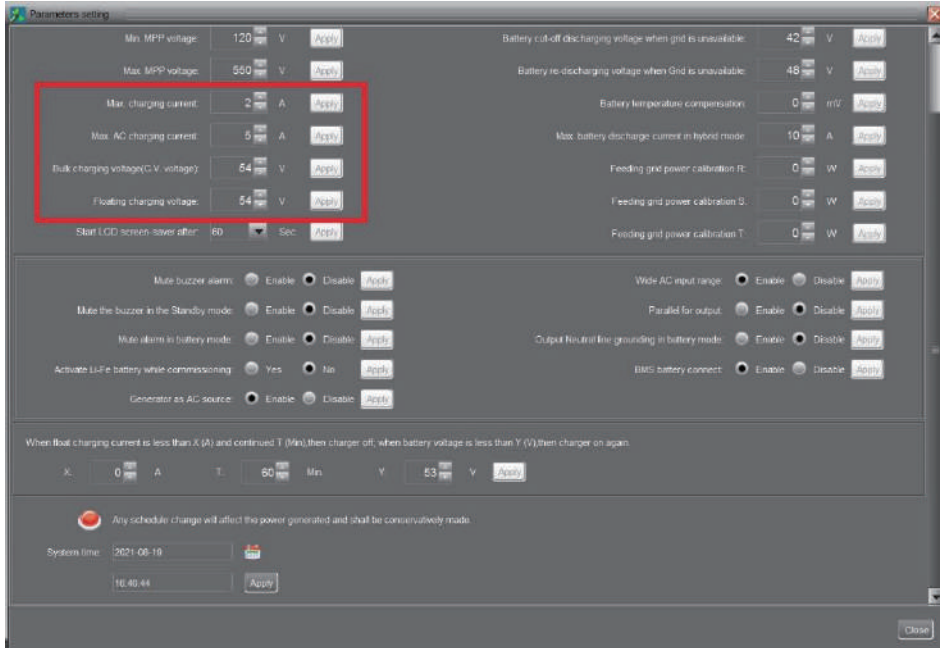

15. Maintenance & Cleaning

Check the following points to ensure proper operation of whole solar system at regular intervals.

- Ensure all connectors of this inverter are cleaned all the time.
- Before cleaning the solar panels, be sure to turn off PV DC breakers.
- Clean the solar panels, during the cool time of the day, whenever it is visibly dirty.
- Periodically inspect the system to make sure that all wires and supports are securely fastened in place.

WARNING: There are no user-replaceable parts inside of the inverter. Do not attempt to service the unit yourself.

Battery Maintenance

- Servicing of batteries should be performed or supervised by personnel knowledgeable about batteries and the required precautions.
- When replacing batteries, replace with the same type and number of batteries or battery packs.
- The following precautions should be observed when working on batteries:
 - a) Remove watches, rings, or other metal objects.
 - b) Use tools with insulated handles.
 - c) Wear rubber gloves and boots.
 - d) Do not lay tools or metal parts on top of batteries.
 - e) Disconnect charging source prior to connecting or disconnecting battery terminals.
 - f) Determine if battery is inadvertently grounded. If inadvertently grounded, remove source from ground. Contact with any part of a grounded battery can result in electrical shock. The likelihood of such shock can be reduced if such grounds are removed during installation and maintenance (applicable to equipment and remote battery supplies not having a grounded supply circuit).

CAUTION: A battery can present a risk of electrical shock and high short-circuit current.

CAUTION: Do not dispose of batteries in a fire. The batteries may explode.

CAUTION: Do not open or mutilate batteries. Released electrolyte is harmful to the skin and eyes. It may be toxic.

















16. Trouble Shooting

When there is no information displayed in the LCD, please check if PV module/battery/grid connection is correctly connected.

NOTE: The warning and fault information can be recorded by remote monitoring software.

16-1. Warning List

There are 17 situations defined as warnings. When a warning situation occurs,  icon will flash. Touch "up" or "down" to select displaying warning code. If there are several codes, it will display in sequences. Please contact your installer when you couldn't handle with the warning situations.

Code	Warning Event	Icon (flashing)	Description
01	Line voltage high loss		Grid voltage is too high.
02	Line voltage low loss		Grid voltage is too low.
03	Line frequency high loss		Grid frequency is too high.
04	Line frequency low loss		Grid frequency is too low.
05	Line voltage loss for long time		Grid voltage is higher than 253V.
06	Ground Loss		Ground wire is not detected.
07	Island detect		Island operation is detected.
08	Line waveform loss		The waveform of grid is not suitable for inverter.
09	Line phase loss		The phase of grid is not in right sequence.
10	EPO detected		EPO is open.
11	Overload		Load exceeds rating value.
12	Over temperature		The temperature is too high inside.
13	Batter voltage low		Battery discharges to low alarm point.
14	Battery under-voltage when grid is loss		Battery discharges to shutdown point.
15	Battery open		Battery is unconnected or too low.
16	Battery under-voltage when grid is OK		Battery stops discharging when the grid is OK.
17	Solar over voltage		PV voltage is too high.

18	RSD is close		RSD is close
32	Communication lost between DSP and communication board		Communication lost between DSP and communication board

16-2. Fault Reference Codes

When a fault occurs, the icon **ERROR** will flash as a reminder. See below for fault codes for reference.

Situation			Solution
Fault Code	Fault Event	Possible cause	
01	Bus voltage over	Surge	1. Restart the inverter. 2. If the error message still remains, please contact your installer.
02	BUS voltage under	PV or battery disconnect suddenly	1. Restart the inverter 2. If the error message still remains, please contact your installer.
03	BUS soft start time out	Internal components failed.	Please contact your installer.
04	INV soft start time out	Internal components failed.	Please contact your installer.
05	INV over current	Surge	1. Restart the inverter. 2. If the error message still remains, please contact your installer.
06	Over temperature	Internal temperature is too high.	1. Check the ambient temperature and fans. 2. If the error message still remains, please contact your installer.
07	Relay fault	Internal components failed.	Please contact your installer.
08	CT sensor fault	Internal components failed.	Please contact your installer.
09	Solar input power abnormal	1. Solar input driver damaged. 2. Solar input power is too much when voltage is more than 600V.	1. Please check if solar input voltage is higher than 600V. 2. Please contact your installer.
11	Solar over current	Surge	1. Restart the inverter.

			2. If the error message still remains, please contact your installer.
12	GFCI fault	Leakage current exceeds the limit.	1. Check the wire and panels which may cause the leakage.
13	PV ISO fault	The resistance between PV and ground is too low.	2. If the error message still remains, please contact your installer.
14	INV DC current over	Utility fluctuates.	1. Restart the inverter. 2. If the error message still remains, please contact your installer.
16	GFCI sensor fault	GFCI sensor failed.	Please contact your installer.
17	DSP and MCU Com. Loss	Communication loss between DSP and MCU	Please contact your installer.
22	Battery high voltage fault	Battery voltage exceeds the limit.	1. Check the battery voltage. 2. If the error message still remains, please contact your installer.
23	Over load	The inverter is loaded with more than 110% load and time is up.	Reduced the connected load by switching off some equipment.
26	INV short	Output short circuited.	Check if wiring is connected well and remove abnormal load.
27	Fan lock	Fan failed.	Please contact your installer.
32	DC/DC over current	Battery voltage fluctuates.	1. Restart the inverter. 2. If the error message still remains, please contact your installer.
33	INV voltage low	Internal components failed.	Please contact your installer.
34	INV voltage high	Internal components failed.	Please contact your installer.
35	Wire connection fault	Internal wires loosen.	Please contact your installer.
36	OP voltage fault	Grid connects to output terminal	Don't connect the grid to the output terminal.
38	Short circuited on PV input	Short circuited on PV input	Please contact your installer.
47	The L1/L2 of the	Output short	Check if all wiring is connected

	inverter is short-circuited.	circuited.	well and remove abnormal loads.
60	Current feedback into the inverter is detected.		<ol style="list-style-type: none"> 1. Restart the inverter. 2. Check if L1/L2/N cables are not connected with wrong sequence in all inverters. 3. Make sure the sharing cables are connected in all inverters. 4. If the problem remains, please contact your installer.
71	The firmware version of each inverter is not the same.	Software differences do not support parallel.	<ol style="list-style-type: none"> 1. Update all inverter firmware to the same version. 2. After updating, if the problem still remains, please contact your installer.
72	The output current of each inverter is different.		<ol style="list-style-type: none"> 1. Check if sharing cables are connected well and restart the inverter. 2. If the problem remains, please contact your installer.
80	CAN data loss		<ol style="list-style-type: none"> 1. Check if communication cables are connected well and restart the inverter. 2. If the problem remains, please contact your installer.
81	Host data loss		
82	Synchronization data loss		
88	BUS Balances overcurrent	Internal components failed.	Please contact your installer.
89	BUS balance hardware Fault	Internal components failed.	Please contact your installer.

17. Specifications

MODEL	12KW
RATED POWER	10000 W
PV INPUT (DC)	
Maximum DC Power	12000 W
Nominal DC Voltage	360 VDC
Maximum DC Voltage	600 VDC
Working DC Voltage Range	120 VDC ~ 550 VDC
Start -up Voltage/Initial Feeding Voltage	125 VDC / 160 VDC
MPP Voltage Range / Full Load MPP Voltage Range	120 VDC ~ 550 VDC
Maximum Input Current	2 x 18 A (MAX 30 A)
Isc PV (absolute maximum)	2 x 18 A (MAX 30 A)
Max. inverter back feed current to the array	0 A
GRID OUTPUT (AC)	
Nominal Output Voltage	120 VAC (P-N) / 208 VAC (P-P)/ 240 VAC(P-P)
Output Voltage Range	105.5 - 132 VAC per phase
Output Frequency Range	47.5 ~ 51.5 Hz or 59.3~ 60.5Hz
Nominal Output Current	41.7A per phase
Inrush Current /Duration	50 A per phase / 20ms
Maximum Output Fault Current /Duration	90 A per phase / 1ms
Maximum Output Overcurrent Protection	90 A per phase
Power Factor Range	0.9 lead – 0.9 lag
AC INPUT	
AC Start -up Voltage	85 VAC per phase
Auto Restart Voltage	90 VAC per phase
Acceptable Input Voltage Range	85 - 140 VAC per phase
Nominal Frequency	50 Hz / 60 Hz
AC Input Power	10000VA/10000W
Maximum AC Input Current	60 A
Inrush Input Current	60 A / 1ms
BATTERY MODE OUTPUT (AC)	
Nominal Output Voltage	120 VAC (P-N) / 208 VAC (P-P)/ 240 VAC(P-P)
Output Frequency	50 Hz / 60 Hz (auto sensing)
Output Waveform	Pure sine wave
Output Power	10000VA/10000W
Efficiency (DC to AC)	91%
BATTERY & CHARGER (Lead -acid/Li-ion)	
DC Voltage Range	40 – 62 VDC
Nominal DC Voltage	48 VDC
Maximum Battery Discharging Current	200 A
Maximum Charging Current	200 A

GENERAL	
PHYSICAL	
Dimension, D X W X H (mm)	215.5 x 515 x 715
Net Weight (kgs)	45
INTERACE	
Communication Port	RS-232/USB
Intelligent Slot	RS232/USB,BMS, WIFI
ENVIRONMENT	
Protective Class	I
Ingress Protection Rating	IP65
Humidity	0 ~ 90% RH (No condensing)
Operating Temperature	-25 to 60°C (Power derating above 45°C)
Altitude	Max. 2000m*

* Power derating 1% every 100m when altitude is over 1000m.

Appendix I: Parallel Installation Guide

Introduction

This inverter can be used in parallel with maximum 6 units. The supported maximum output power is 60KW/60KVA.

Parallel cable

You will find the following items in the package:



Parallel communication cable

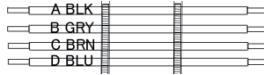

Current sharing wires

Overview

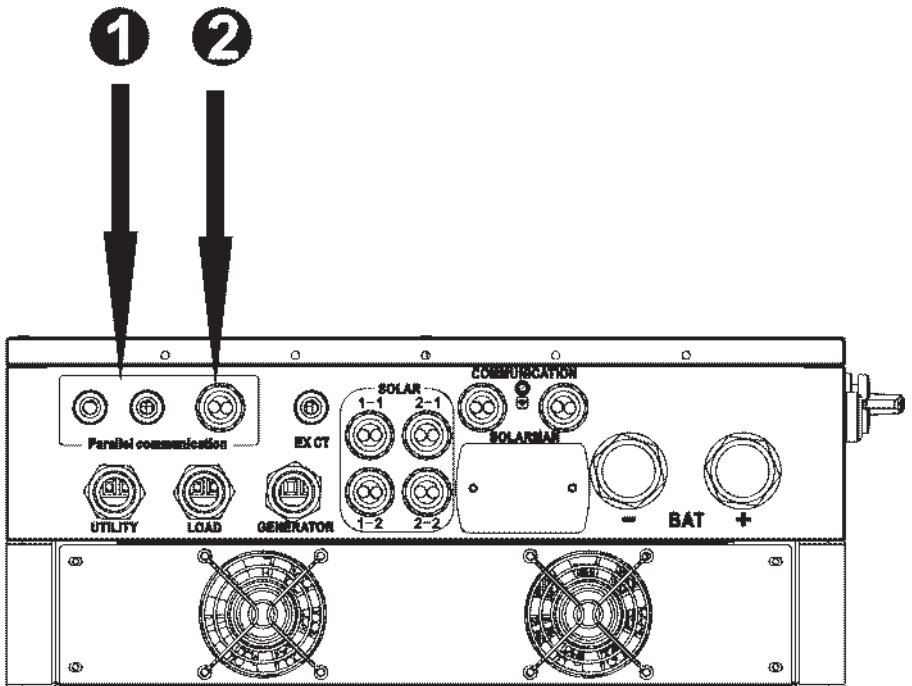

1. Current sharing port
2. Parallel communication port

Mounting the Unit

When installing multiple units, please follow below chart.

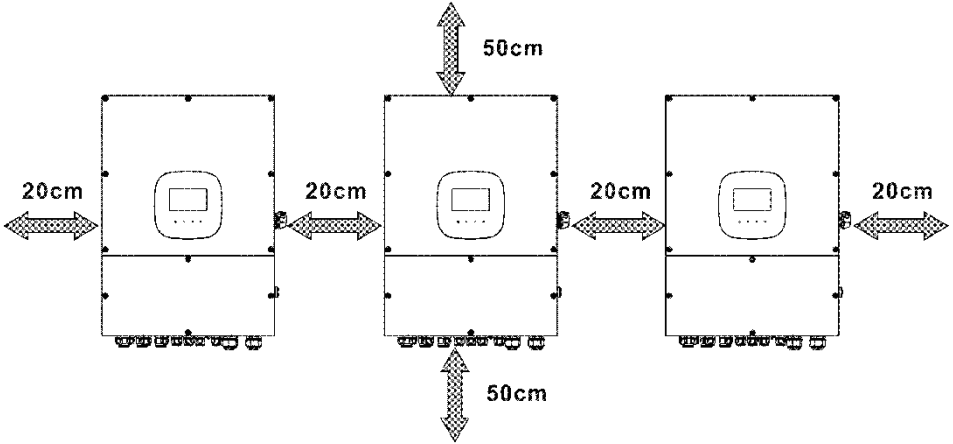

NOTE: For proper air circulation to dissipate heat, it's necessary to allow a clearance of approx. 20 cm to the side and approx. 50 cm above and below the unit. Be sure to install each unit in the same level.

Wiring Connection

The cable size of each inverter is shown as below:

Recommended battery cable and terminal size for each inverter:

Ring terminal:

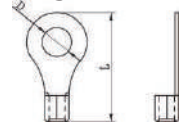

Wire Size	Ring Terminal			Torque value
	Cable mm ²	Dimensions		
		D (mm)	L (mm)	
3/0AWG	85	8.4	56	7~12 Nm

WARNING: Be sure the length of all battery cables is the same. Otherwise, there will be voltage difference between inverter and battery to cause parallel inverters not working.

Recommended AC input and output cable size for each inverter:

AWG no.	Conductor cross-section	Torque
8-6 AWG	10~16 mm ²	1.4~1.6Nm

You need to connect the cables of each inverter together. Take the battery cables for example. You need to use a connector or bus-bar as a joint to connect the battery cables together, and then connect to the battery terminal. The cable size used from joint to battery should be X times cable size in the tables above. "X" indicates the number of

inverters connected in parallel.

Regarding cable size of AC input and output, please also follow the same principle.

CAUTION!! Please install a breaker at the battery side. This will ensure the inverter can be securely disconnected during maintenance and fully protected from overcurrent of battery.

Recommended breaker specification of battery for each inverter:

One unit*
250A/60VDC

*If you want to use only one breaker at the battery side for the whole system, the rating of the breaker should be X times current of one unit. "X" indicates the number of inverters connected in parallel.

Recommended battery capacity

Inverter parallel numbers	2	3	4	5	6
Battery Capacity	400AH	600AH	800AH	1000AH	1200AH

CAUTION! Please follow the battery charging current and voltage from battery spec to choose the suitable battery. The wrong charging parameters will reduce the battery lifecycle sharply.

Approximate back-up time table

Load (W)	Backup Time @ 48Vdc 400Ah (min)	Backup Time @ 48Vdc 600Ah (min)	Backup Time @ 48Vdc 800Ah (min)	Backup Time @ 48Vdc 1000Ah (min)	Backup Time @ 48Vdc 1200Ah (min)
20000	54	84	108	144	168
30000	36	54	72	96	108
40000	24	42	54	72	84
50000	21	33	45	54	66
60000	18	30	36	48	60

PV Connection

Please refer to user manual of single unit for PV Connection.

CAUTION: Each inverter should connect to PV modules separately.

Inverters Configuration

Two inverters in parallel:

Power Connection

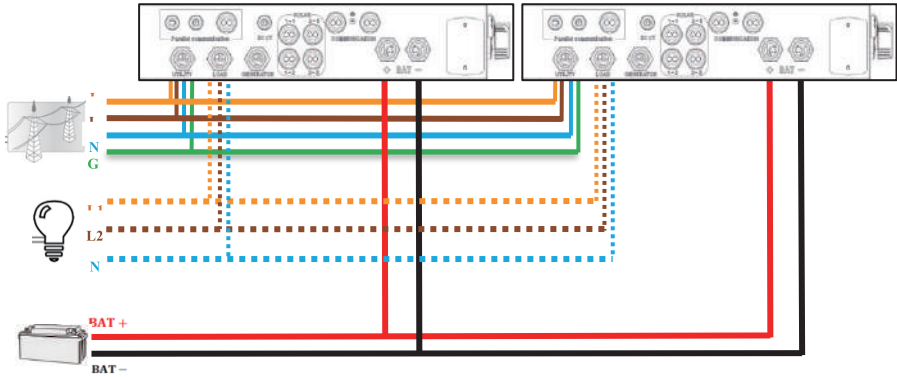

Communication Connection

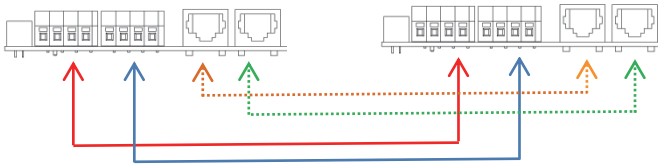

Six inverters in parallel:

Power Connection

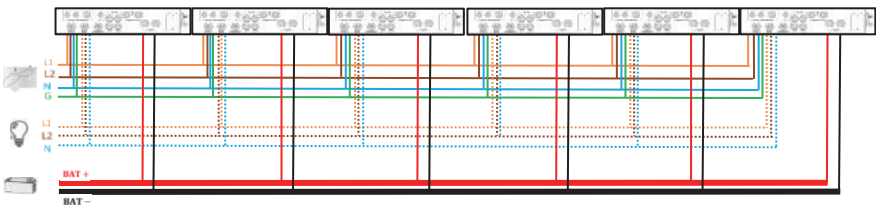

Communication Connection

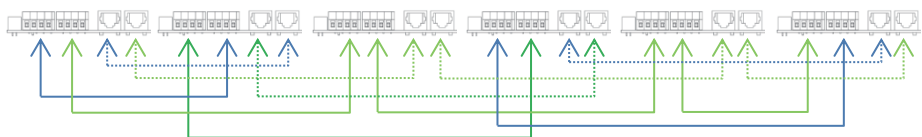



Setting and LCD Display Setting Program:

The parallel function setting can be set up through software or LCD setting #32. When setting through software, you can set the inverter one by one through USB or RS-232 port.

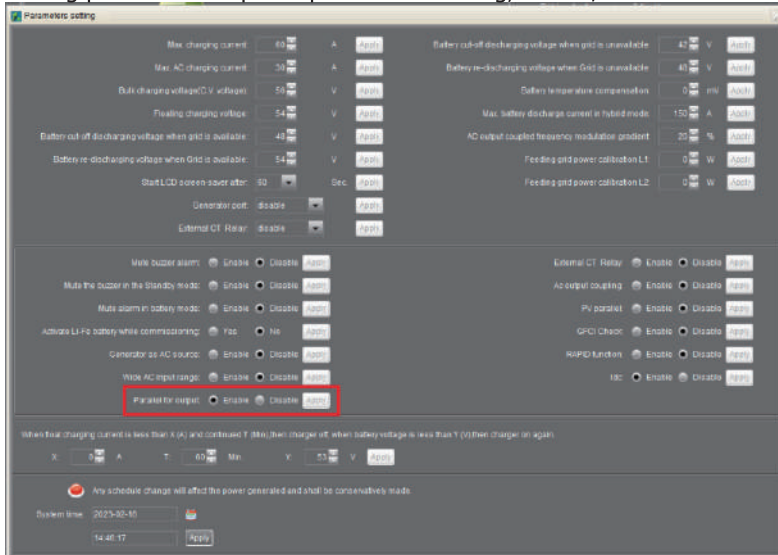
- Through software:
Setting parallel for output in parameters setting, enable/disable.

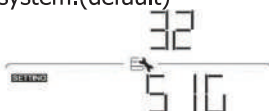

- Through LCD operation
In LCD program 32, you may select single or parallel.

32	Parallel for output	<p>Single: This inverter is operated in Single system.(default)</p> 	<p>Parallel: This inverter is operated in parallel system.</p> 
----	---------------------	---	---

Commissioning

Step 1: Check the following requirements before commissioning:

- Correct wire connection.
- Ensure all breakers in Line wires of load side are open and each Neutral wire of each unit is connected together.

Step 2: Turn on each unit and set "enable parallel for output" on SolarPower or SolarPower Pro. And then, shut down all units.

Step 3: Turn on each unit.

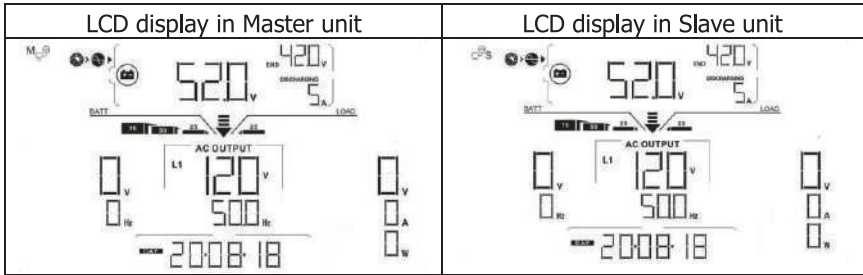

NOTE: Master and slave units are randomly defined. Warning 02 is AC GRID voltage low.

Step 4: Switch on all AC breakers of Line wires in AC input. It's better to have all inverters connect to utility at the same time. If not, it will display fault 82 in following-order inverters. However, these inverters will automatically restart. If detecting AC connection, they will work normally.

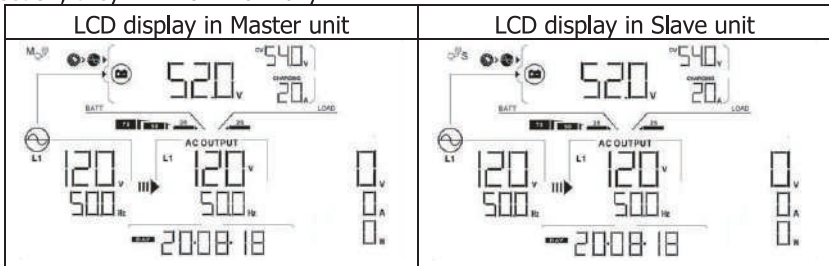

Step 5: If there is no more fault alarm, the parallel system is completely installed.

Step 6: Please switch on all breakers of Line wires in load side. This system will start to provide power to the load.

Trouble shooting

Situation		Solution
Fault Code	Fault Event Description	
60	Current feedback into the inverter is detected.	<ol style="list-style-type: none"> 1. Restart the inverter. 2. Check if L1/L2/N cables are not connected with wrong sequence in all inverters. 3. Make sure the sharing cables are connected in all inverters. 4. If the problem remains, please contact your installer.
61	Relay board driver loss	<ol style="list-style-type: none"> 1. Disconnect all of power source. 2. Only connect AC input and press Enter key to let it working in bypass mode. 3. Check if the problem happens again or not and feed back the result to your installer.
62	Relay board communication loss	
71	The firmware version of each inverter is not the same.	<ol style="list-style-type: none"> 1. Update all inverter firmware to the same version. 2. After updating, if the problem still remains, please contact your installer.
72	The output current of each inverter is different.	<ol style="list-style-type: none"> 1. Check if sharing cables are connected well and restart the inverter. 2. If the problem remains, please contact your installer.
80	CAN data loss	<ol style="list-style-type: none"> 1. Check if communication cables are connected well and restart the inverter. 2. If the problem remains, please contact your installer.
81	Host data loss	
82	Synchronization data loss	

Appendix II: The Wi-Fi Operation Guide

1. Introduction

Wi-Fi module can enable wireless communication between hybrid inverters and monitoring platform. Users have complete and remote monitoring and controlling experience for inverters when combining Wi-Fi module with i.Solar APP, available for both iOS and Android based device. This App is based on Wi-Fi chip to provide remote monitoring data services, which is beneficial to the daily data monitoring of the inverter, including querying the real-time data in the device, sending commands from the device, and operating the device remotely.

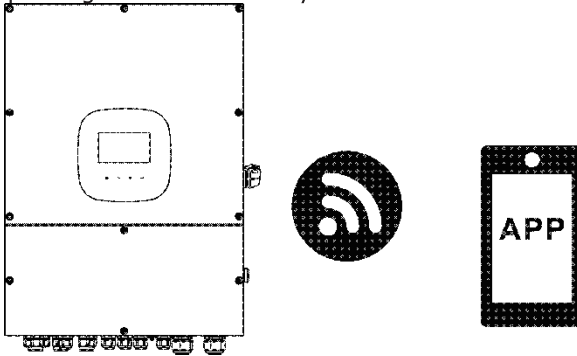

2. i.Solar App

2-1. Download and install APP

Operating system requirement for your smart phone:

 iOS system supports iOS 12.0 and above

 Android system supports Android 10.0 and above

You may find “i.Solar” app from the Apple® Store and Google® Play Store.

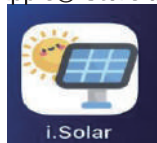

2-2. WiFi Model Setting

Step 1: Turn on the device.

Step 2: Open the mobile's Wi-Fi settings

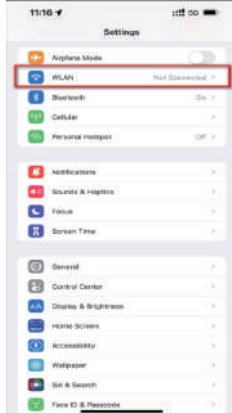

Step 3: Connect your mobile to this Wi-Fi. The Wi-Fi name starts with "FC41D_". The default password for this Wi-Fi is 12345678.



Step 4: After the Wi-Fi connection is successful, click the i.Solar App installed on the phone to enter the login page. Then, click the "Network Config" button to enter the Wi-Fi configuration page.





Step 5: After click the “Network Config” button to enter the Wi-Fi configuration page shown below.

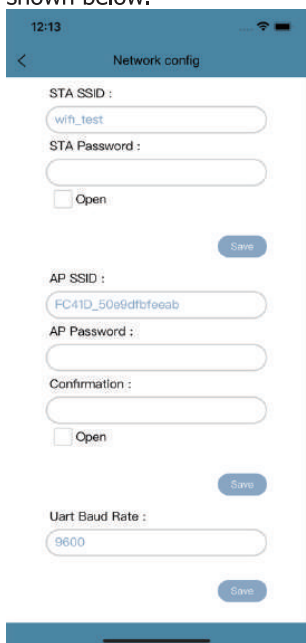

Step 6: Enter your Wi-Fi name (AP SSID) and Wi-Fi password (AP Password), then click the "Save" button to complete the setting.

If you check "Open" marked in yellow, you only need to enter the Wi-Fi name (AP SSID), no need to enter the Wi-Fi password. Then, Click the "Save" button to complete the setting.

12:13

< Network config

STA SSID :

wifi_test

STA Password :

Open

Save

AP SSID :

FC41D_50e9dfbf0e0b

AP Password :

Confirmation :

Open

Save

Uart Baud Rate :

9600

Save

Step 7: Enter the Wi-Fi name (AP SSID) and Wi-Fi password (AP Password) of the Wi-Fi card, confirm the password again and click the "Save" button to complete the setting of the Wi-Fi card.

If you check "Open" marked in yellow, you only need to enter the Wi-Fi name (AP SSI , no need to enter the Wi-Fi password and Confirmation. Then, Click the "Save" button to complete the setting.



Step 8: After entering the value of the baud rate, click the "Save" button to complete the setting of Uart Baud Rate.

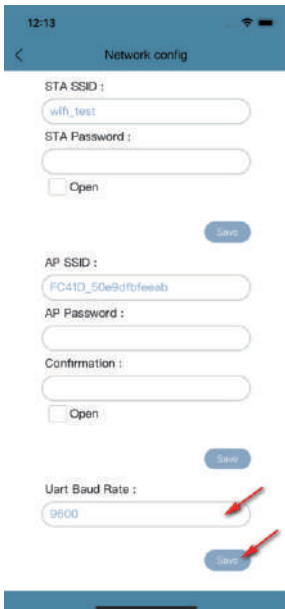

2-3. Login

After opening the app, enter the login page shown below:

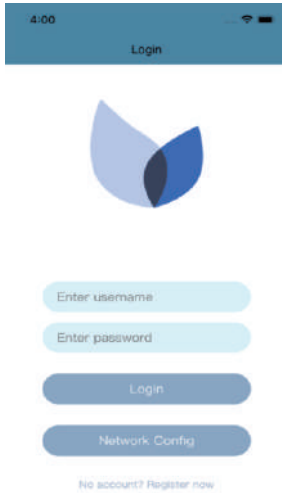

Click Register now to register.

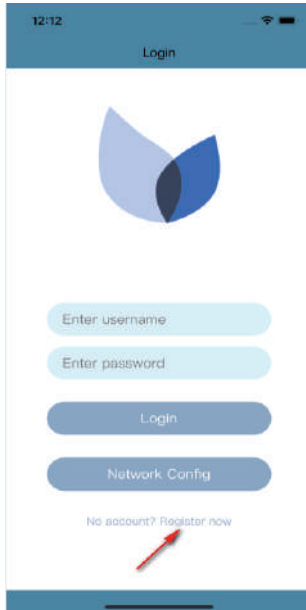

After enter the registration page, enter the user name, password, and confirm the password (marked in blue arrows). Then, click the Register button to register, the

following prompt will pop up, click the OK button in the prompt box to complete the user registration.

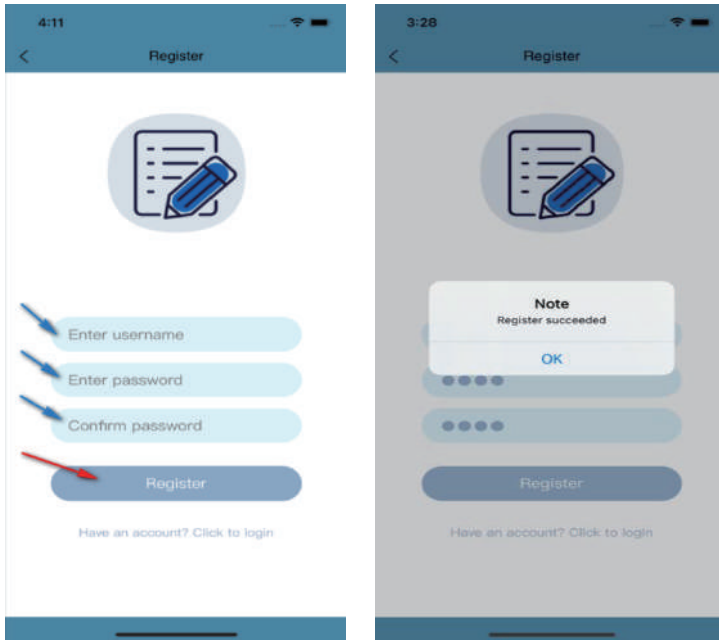

Once registration is complete, click "Click to log in" or return to the previous page (swipe left or click the left arrow to return to the login page). Then, enter the registration page. Complete the user name and password to log in.

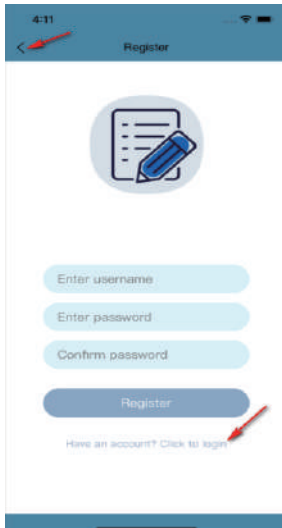

2-4. Home Page

Login to enter the App, the default Home page will appear.

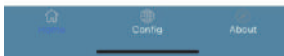
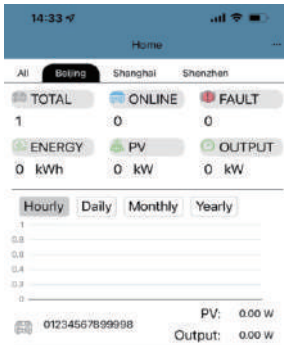

The red box is the grouping area:

- All: Display the device information of all groups. Click the small red arrow box area to switch to the specified group, and view the device information of different groups. You can also switch groups by swiping left and right on the as shown, you can view the device data and status in this group.

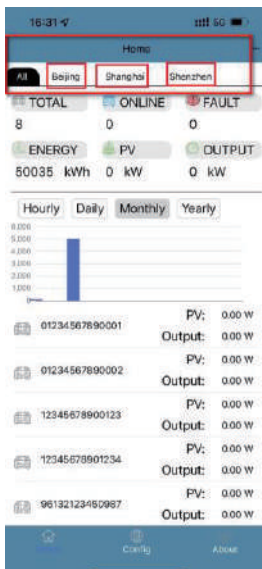

The blue box is the summary data area:

- TOTAL: View the number of all devices,
- ONLINE: View the current number of online devices,
- FAULT: View the number of faulty devices,
- ENERGY: Total power generation data,
- PV: Input power data,
- OUTPUT: Output power data,

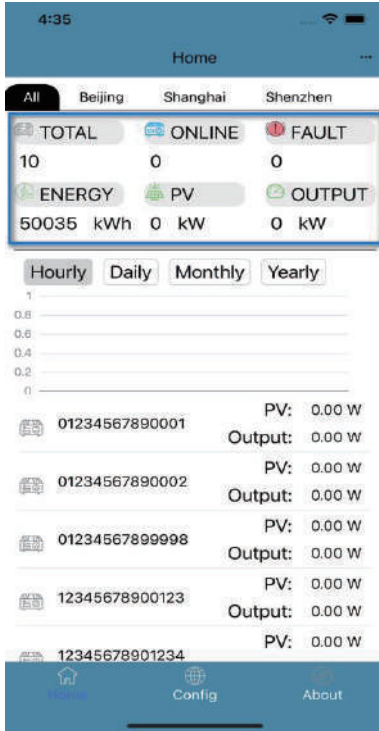

The green box is the chart data area:

- Hourly: Click the button to query the hourly power generation of the day
- Daily: Click the button to query the daily power generation data of the current month,
- Monthly: Click the button to query the monthly power generation data of the current year,
- Yearly: Click the button to query the annual power generation data.

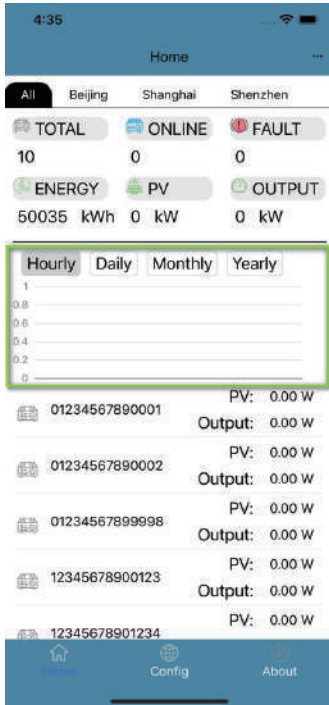

The purple box is the device status area:

For example: blue arrow, slide up and down on the page to view the input and output power data and device status of all devices on the current page. Red arrow part: the gray color of the device means that the device is offline, the blue color of the device means that the device is online, the yellow color of the device means that the device has an alarm, and the red color of the device means that the device is faulty.

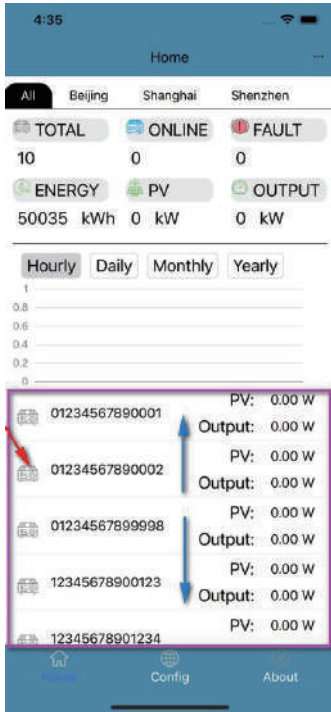

2-4-1. Group

Click the three dots in the upper right corner of the Home page (as shown by the arrow). You can view the group information, modify the group name, delete a group, and add a group.

As the picture shows:

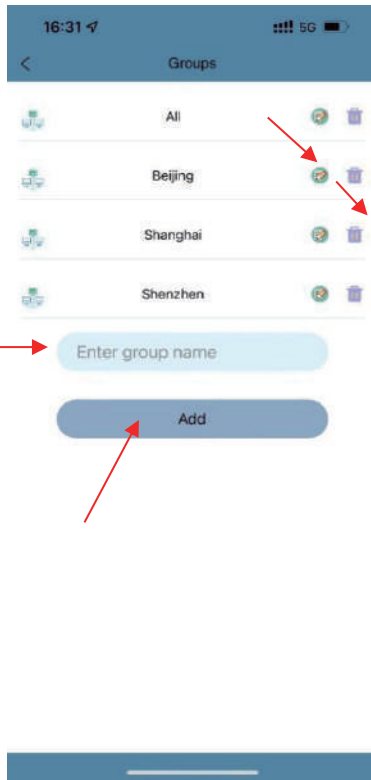
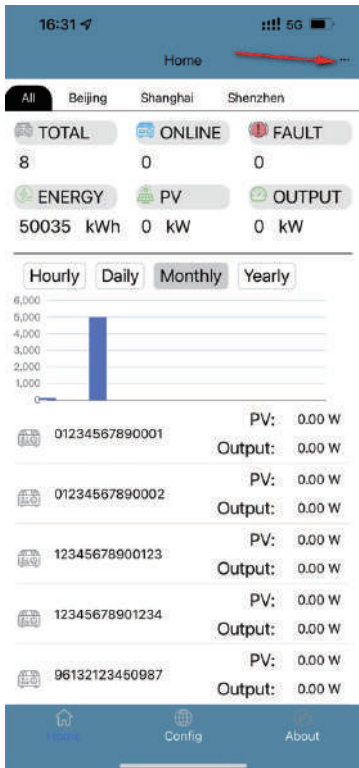

Click the modify icon to modify the corresponding group name, click the delete icon to delete the corresponding group, enter the group name in the input box, and click the Add button to realize the function of adding a group.

2-4-2. Device Module

Click the device icon in the grouping module to enter the device page, which displays all the devices in the group.
(As indicated by the arrow):

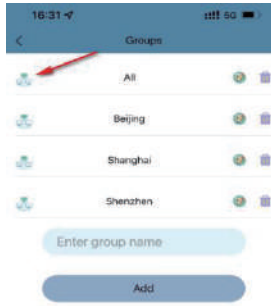

In the device module, you can view device information, and click the corresponding icon to assign devices, add devices, modify device names, and delete devices.

Assign device

Click  icon to enter the device assignment page.

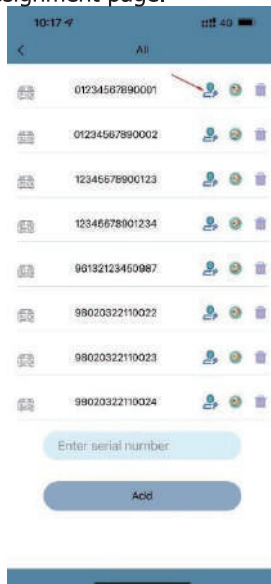

- ① Enter the assigned user name
- ② Select the corresponding authority

- ③ Click the Assign button to realize the function of assigning the device, (the assigned user has the assigned authority), as shown in the figure:

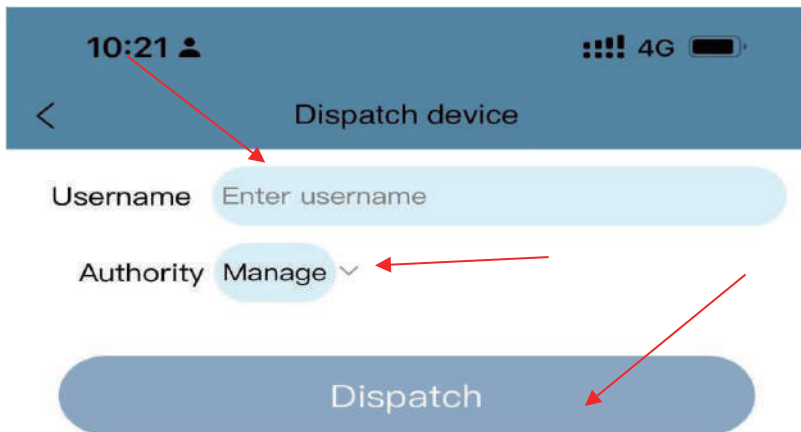

Modify the device name

Click  icon to enter a new device name, and then click the ok button to realize the function of modifying the device name.

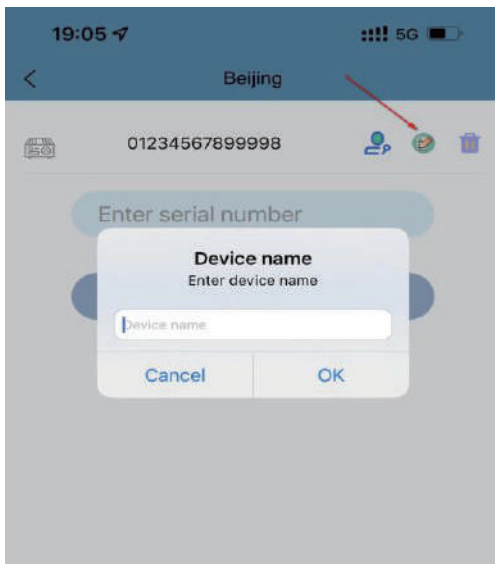

Delete device

Click the delete icon  to confirm ok to delete the device as shown below.

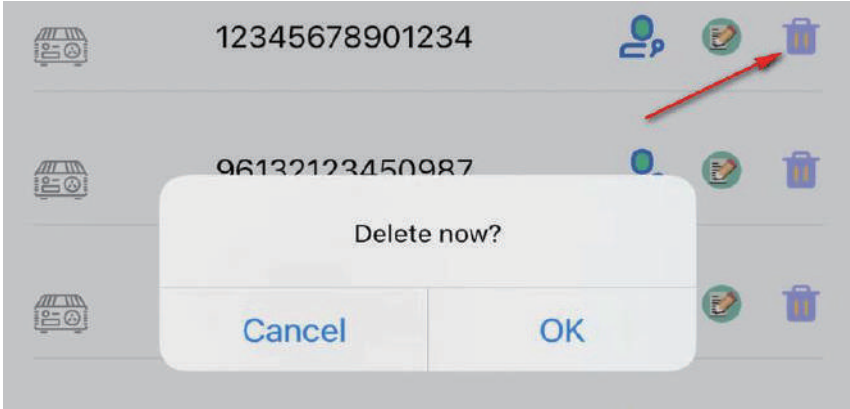

Add device

Enter the device serial number in the text box, and then click the "Add" button to add the device as shown below.

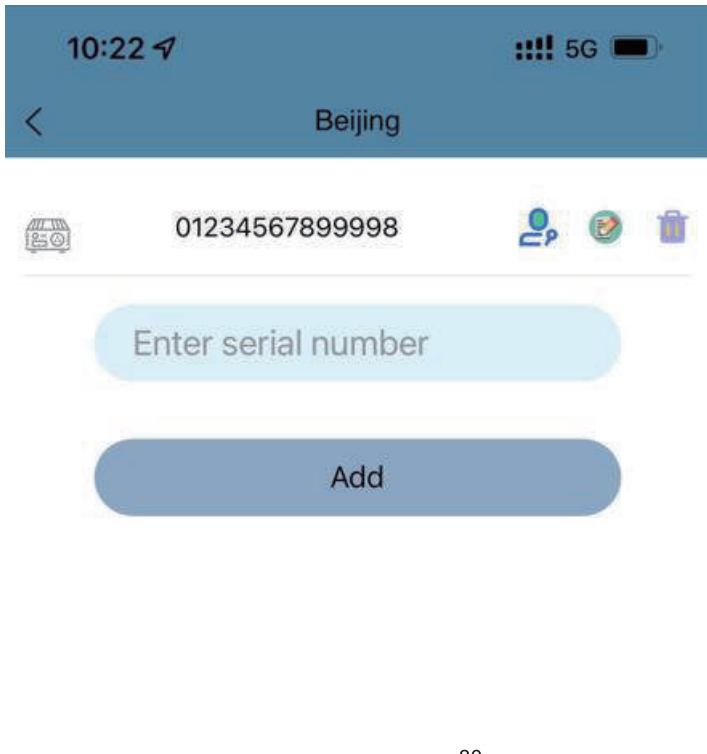

2-4-3. Real-time data

On the Home page, click the following devices to enter the real-time data tab to view the real-time data information of the current device, as shown in the figure:

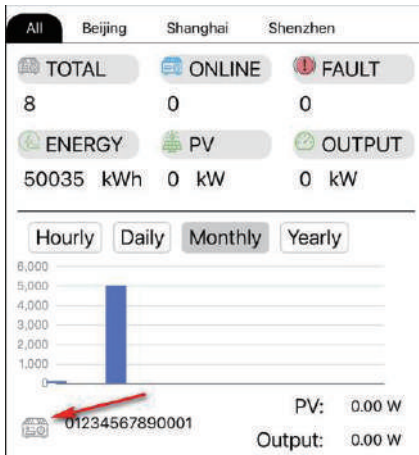

Real-time data information:

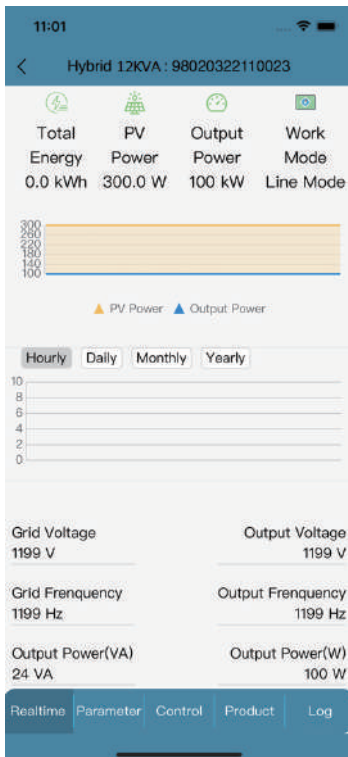

As shown in the figure below, in the red box area, you can view the total power generation data, input and output power data of the current equipment, and the working mode of the equipment.

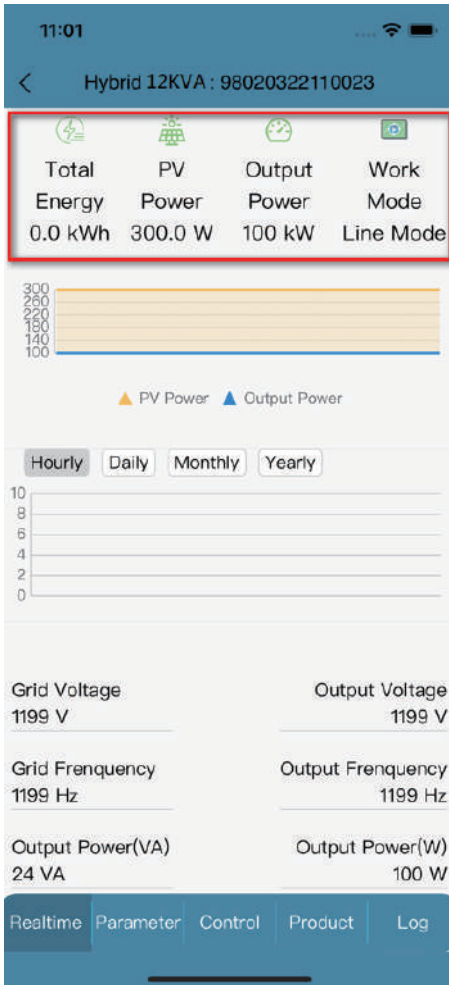

Click the small yellow triangle in the red arrow part below the chart to view the data displayed in the chart of the current device input power, and click the blue small triangle in the red arrow part below the chart to view the data displayed in the chart of the current device output power.

Hourly: Click the button to query the hourly power generation chart data of the device that day, Daily: Click the button to query the daily power generation chart data of the device in the current month, Monthly: Click the button to query the monthly power generation chart data of the device in the current year, Yearly: Click the button to query Chart data of annual power generation of the device.

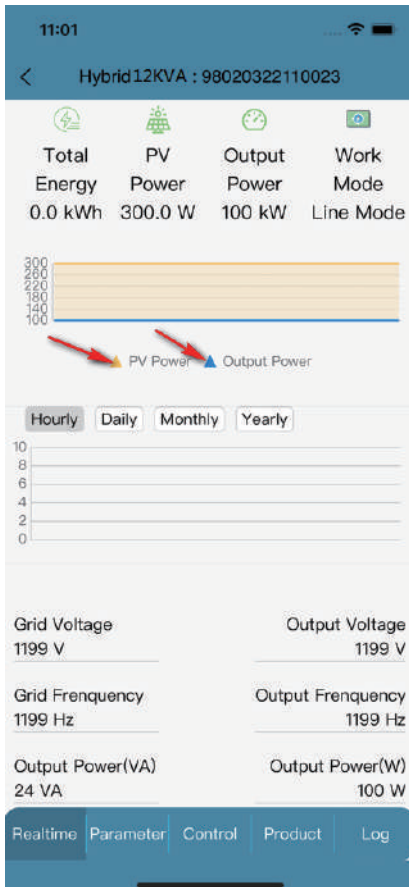

For example: slide up and down on the page to view the real-time data in the current device. The data displayed on the real-time page will be different for different models.

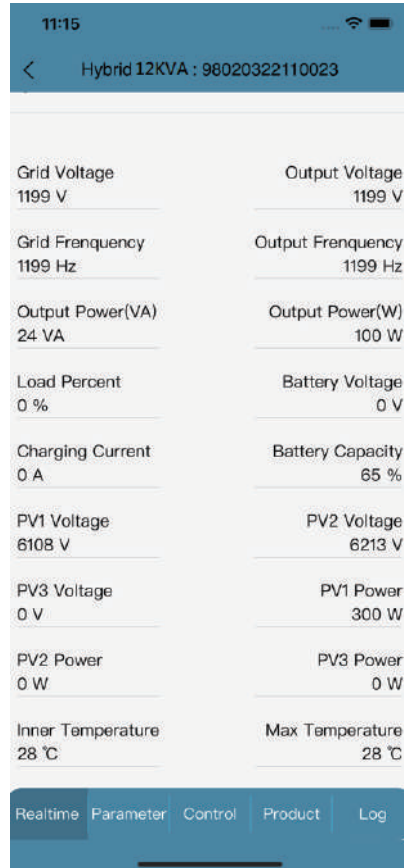
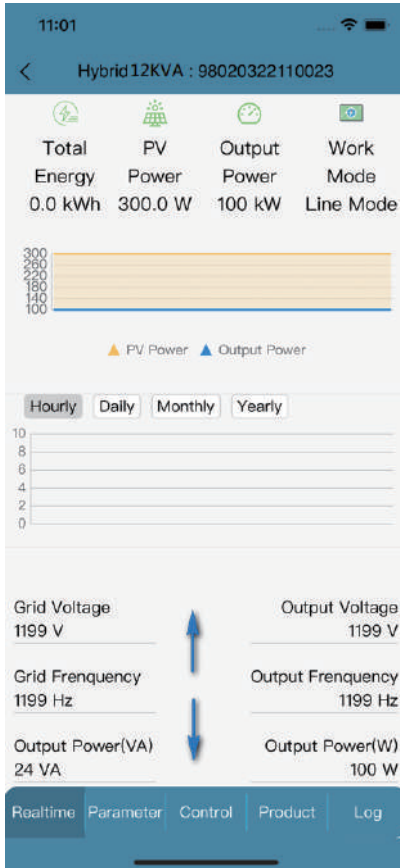

2-4-4. Parameter settings

On the Home page, after selecting the device to enter the real-time page (as shown by the arrow in the figure), click the Parameter tab to enter the parameter setting page, as shown in the figure (different models, the setting items on the parameter page will be different).

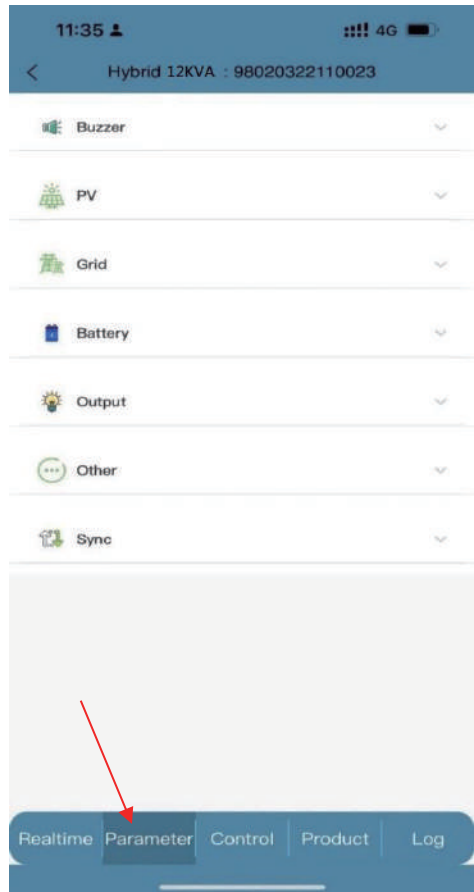
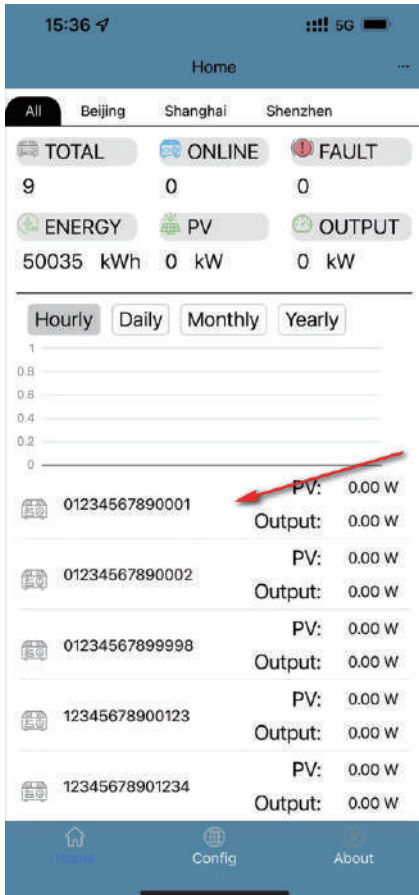

Click to open the tabs as shown:

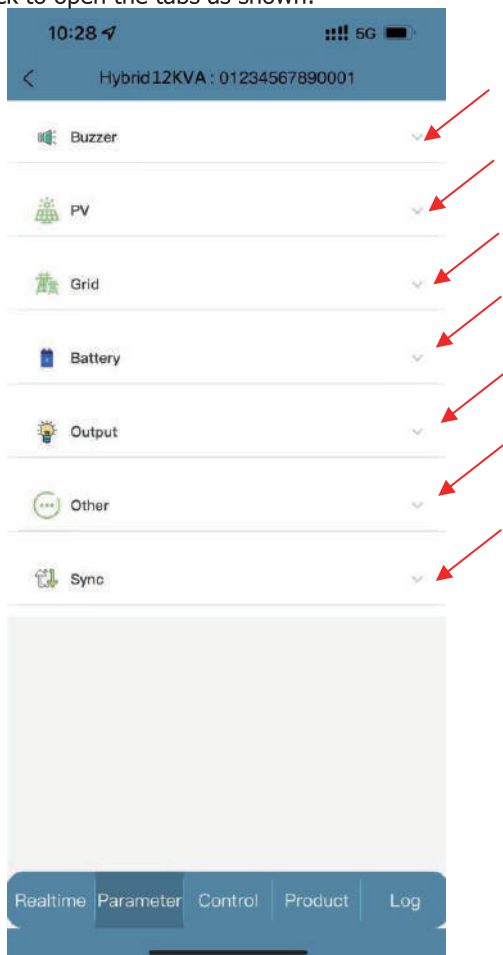

Click the Buzzer tab indicated by the red arrow, and after the blue arrow sets the parameters under Buzzer, click the Apply button to complete the setting of the Buzzer tab parameters.

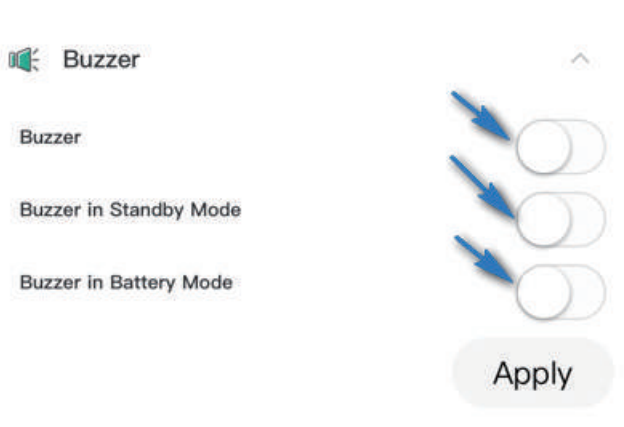

Click the PV tab indicated by the red arrow, and after the blue arrow sets the parameters under PV, click the Apply button to complete the setting of the PV tab parameters.

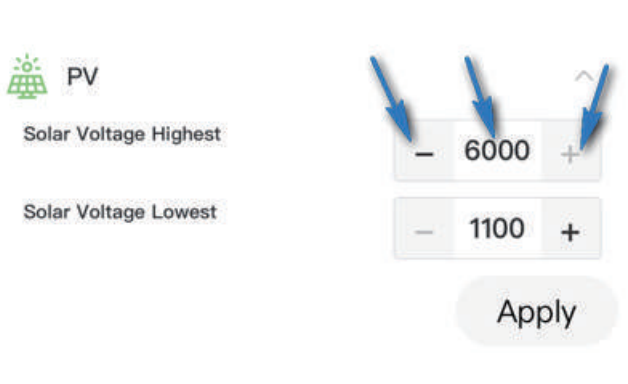

Click the Grid tab pointed out by the red arrow, and after the blue arrow sets the parameters under the Grid, click the Apply button to complete the setting of the Grid tab parameters.

Ending Time for Enable AC Charger Working 2	11:49
Feed Grid Power	- 6000 +
Feed Grid Wait Time	- 15 +
AC Input Long-time Highest Average Voltage	- 1380 +
Feed Grid Voltage Highest	- 1320 +
Feed Grid Voltage Lowest	- 840 +
Feed Grid Frequency Highest	- 5200 +
Feed Grid Frequency Lowest	- 4750 +
MPPT Voltage Highest	- 5500 +
MPPT Voltage Lowest	- 1200 +

Apply

Click the Battery tab indicated by the red arrow, and after the blue arrow sets the parameters under Battery, click the Apply button to complete the setting of the parameters of the Battery tab.

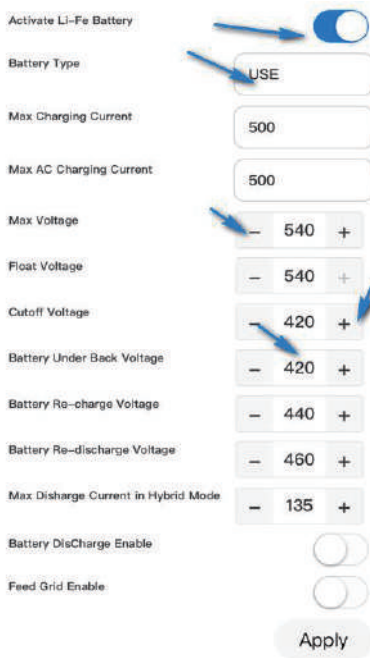

Click the Output tab pointed out by the red arrow, and after the blue arrow sets the parameters under Output, click the Apply button to complete the setting of the parameters of the Output tab.



Click the Output tab pointed out by the red arrow, and after the blue arrow sets the parameters under Output, click the Apply button to complete the setting of the parameters of the Output tab.

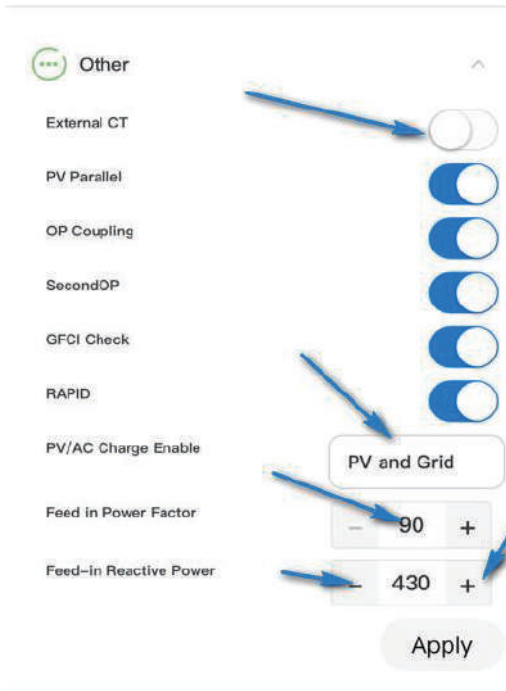

After clicking the Sync tab pointed out by the red arrow, the blue arrow Apply button can complete the setting of the parameters of the Sync tab.

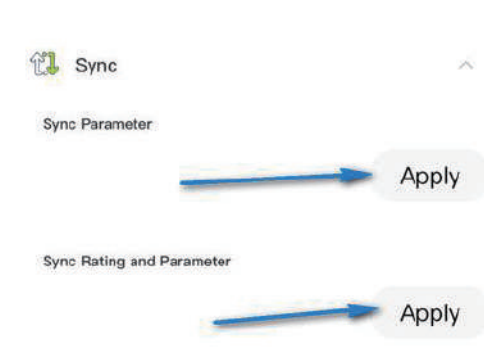

2-4-5. Control Setting

After clicking the corresponding device icon at the bottom of the Home page, click the Control bar to enter the control settings, as shown in the figure:

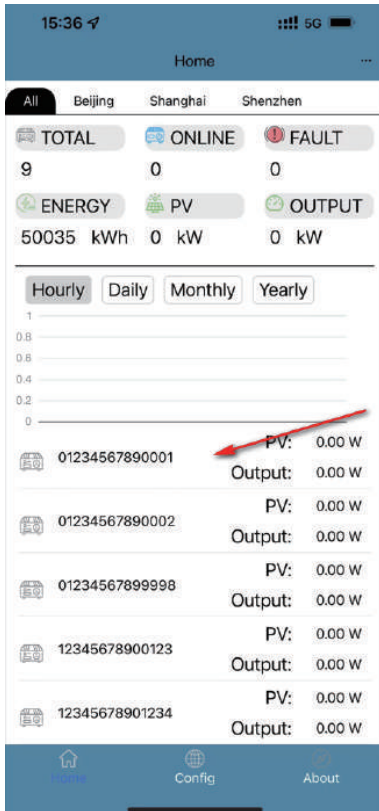

After clicking the Output tab pointed out by the red arrow, after the blue arrow sets the setting items under Output, click the Apply button to save the settings

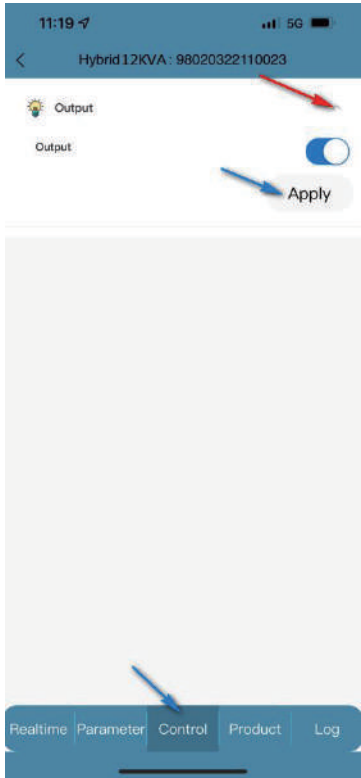

2-4-6. Product Information

On the Home page, select the device to enter the real-time page (as shown by the arrow in the figure), click the Product tab enter the product information, and you can view the product information data and rating information data of the current device.

As the picture shows:

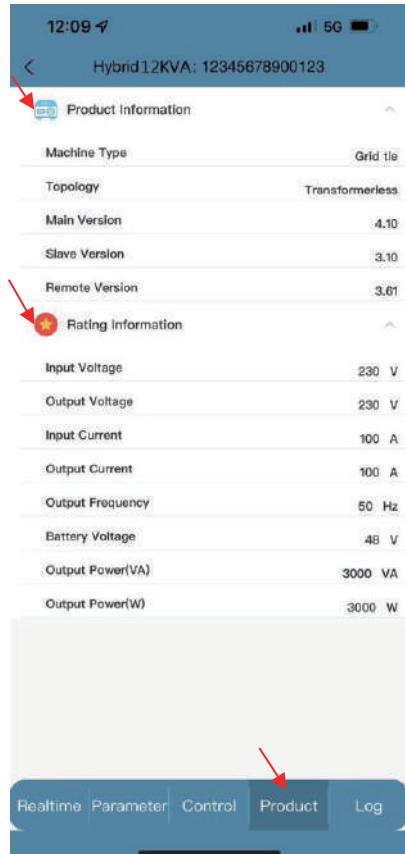
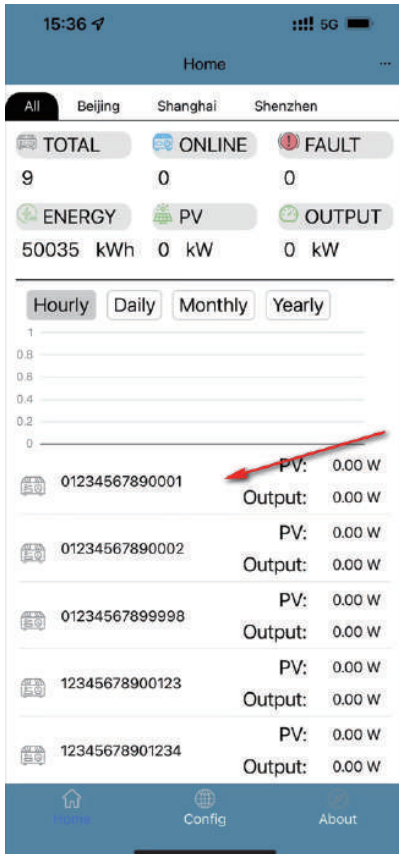

2-4-7. Log Data

After clicking the corresponding device icon at the bottom of the Home page, click the Log tab to enter the product information, and you can view the log data of the current device

As the picture shows:

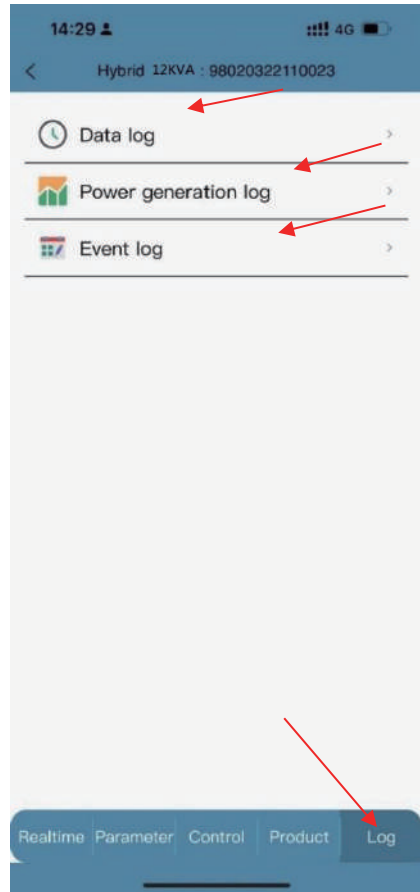
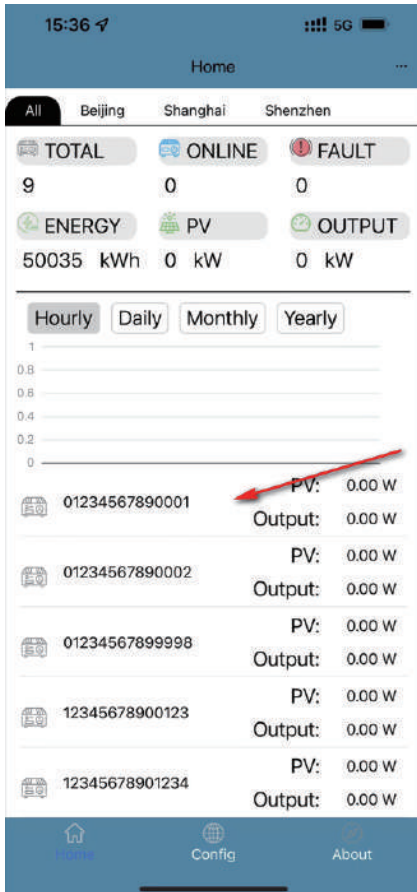

2-5. Configuration

2-5-1. Change the password

After logging in the account and entering the App, click the Config tab to enter the configuration page, and click the Change Password tab to enter the password modification page to modify the current user password.

As the picture shows:

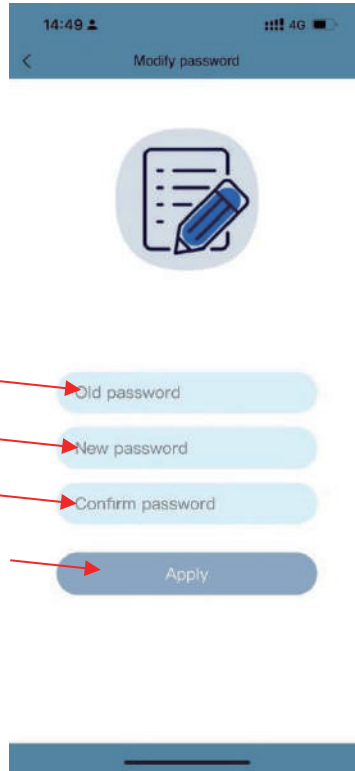
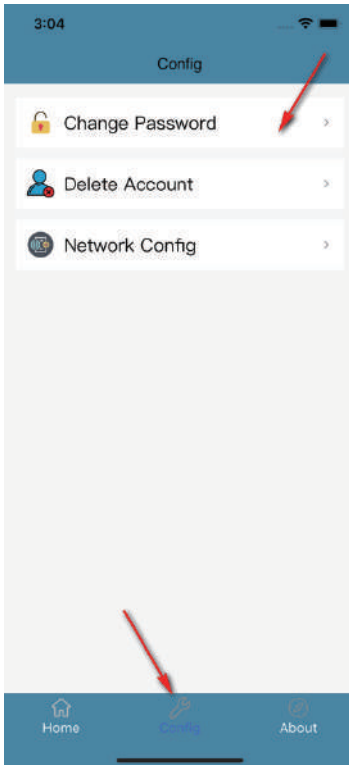

Enter the old password, enter the new password, confirm the new password, and click the Apply button to complete the password modification function.

2-5-2. Remove Account

On the Config page, click the Delete Account tab to enter the delete account page, as shown in the figure below, click the Delete Account button to delete the currently logged in account.

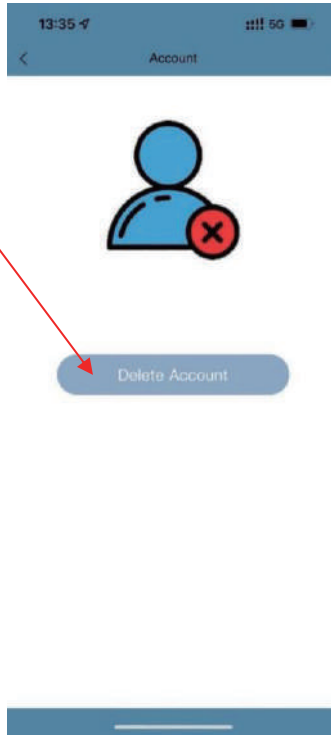
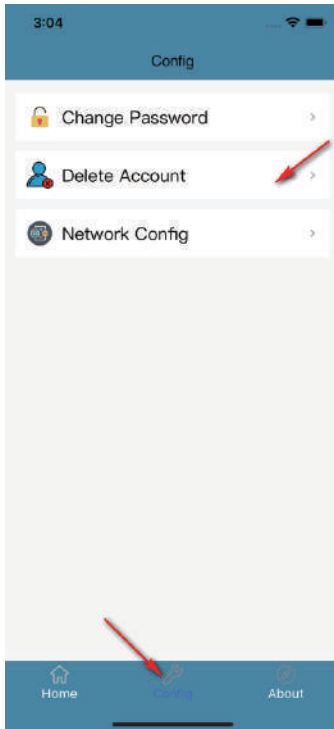

2-5-3. Network Configuration

Click the Config tap to enter the Config page, and click the Network Config tab to enter the network configuration page.

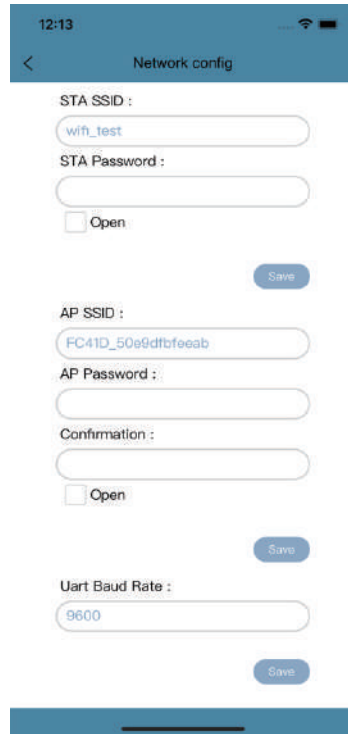
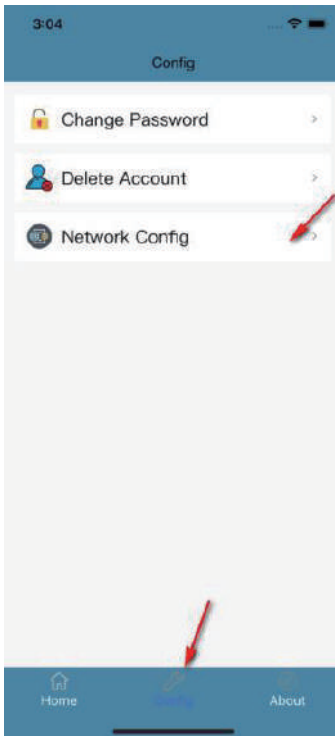

2. The detailed steps of configuration are the same as Wi-Fi MODEL setting at the section.

2-6. About

Click the About tab to enter the About page, where you can view information about the App.

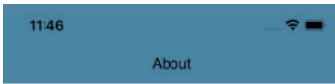

i.Solar v1.0
Powered by,
Copyright © 2022
Trusted UPS Manufacturing Company.
All rights reserved.



Appendix III: The CT Operation Guide

With CT connected, hybrid inverter can be easily integrated into the existing household system. It's to arrange self-consumption via CT to control power generation and battery charging of the inverter.

1. Single commissioning

Step 1. Power off the inverter and connect the CT circuit according to the wiring diagram below.

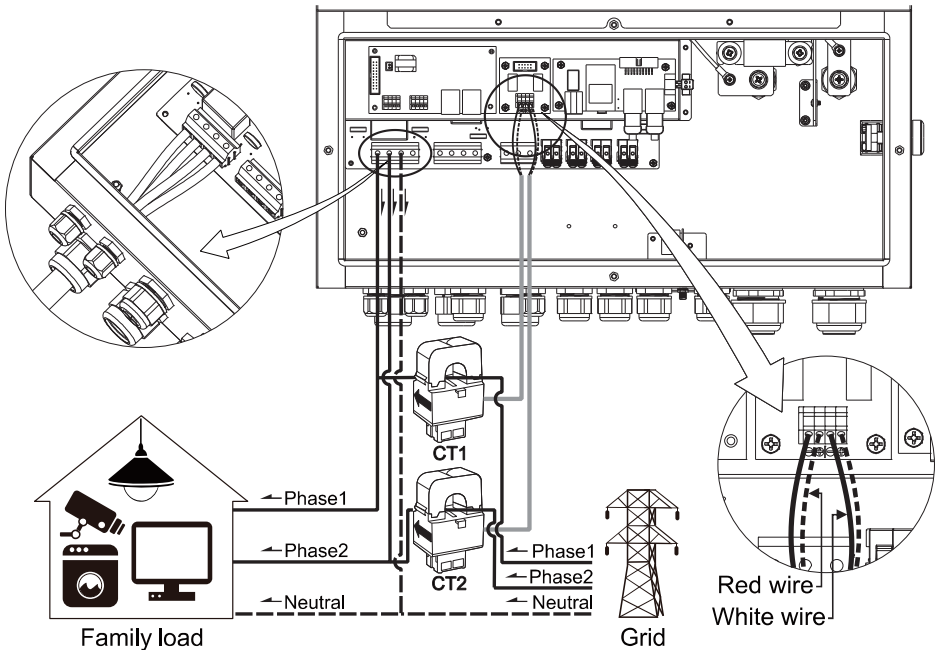

Step 2: Power on the inverter, wake up the LCD and modify LCD setting. Enter LCD program #13 and set up as any Grid-tie with backup mode. The CT will not be enable if not setting to grid-tie with backup.

Step 3: Enter LCD setting on the inverter with CT sensor connected and change program #36 to "enable".

36	External CT function	Disable (default)	Enable

2. Parallel commissioning

Step 1. Power off the inverter and connect the CT sensor according to the wiring diagram below. For other parallel circuits, please follow Appendix I.

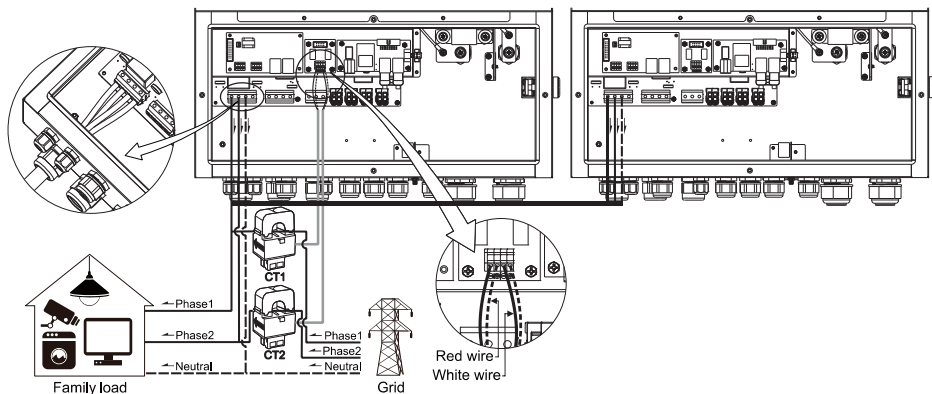

Step 2: Power on all inverters, wake up the LCD and modify the Settings. Enter LCD program #13 and set up as any Grid-tie with backup mode. The CT will not be enabled if not setting to grid-tie with backup.

Step 3: Enter LCD setting on the inverter with CT sensor connected and change program #36 to "enable".

36	External CT function	Disable (default)	Enable

IMPORTANT ATTENTION :

If applying CT function during parallel operation, it only needs one inverter from parallel system connected to CT sensor. Be sure to enable LCD program #36 external CT function on the one inverter with CT connected and set up "Disable" on the remaining inverters. Otherwise, it will cause CT function not working during parallel operation.

3. Software setup

In addition to LCD operation, you also can setup through software. Refer to software screen as below. Enter "Parameters setting" to enable "External CT relay".

Parameters setting

Max. charging current:	90	A	Apply	Battery out-off discharging voltage when grid is unavailable:	42	V	Apply
Max. AC charging current:	30	A	Apply	Battery re-discharging voltage when Grid is unavailable:	48	V	Apply
Bulk charging voltage(C.V. voltage):	56	V	Apply	Battery temperature compensation:	0	mV	Apply
Floating charging voltage:	64	V	Apply	Max. battery discharge current in hybrid mode:	150	A	Apply
Battery cut-off discharging voltage when grid is available:	46	V	Apply	AC output coupled frequency modulation gradient:	20	%	Apply
Battery re-discharging voltage when Grid is available:	64	V	Apply	Feeding grid power calibration L1:	0	W	Apply
Start LCD screen-saver after:	60	Sec.	Apply	Feeding grid power calibration L2:	0	W	Apply
Generator port:	disable		Apply				
External CT Relay:	disable		Apply				

Mute buzzer alarm: Enable Disable

Mute the buzzer in the Standby mode: Enable Disable

Mute alarm in battery mode: Enable Disable

Activate Li-Fe battery while commissioning: Yes No

Generator as AC source: Enable Disable

Wide AC input range: Enable Disable

Parallel for output: Enable Disable

External CT Relay: Enable Disable

AC output coupling: Enable Disable

PV parallel: Enable Disable

GFCI Check: Enable Disable

RAPID function: Enable Disable

Idc: Enable Disable

When float charging current is less than X (A) and continued T (Min), then charger off; when battery voltage is less than Y (V), then charger on again.

X: A T: Min Y: V

Any schedule change will affect the power generated and shall be conservatively made.

System time:

After CT function is enabled, program# 14 will be automatically changed to HBD2, program #15 will automatically set to turn off AC charging and program #16 will be disabled feed-in function.

Appendix IV: The Generator Operation Guide

Through the generator port, the inverter can realize multiple groups of redundant backup power supply. In the absence of grid or solar power, users have the option of using a generator to charge the battery and power the load. Follow below steps to activate this function.

Step 1. Turn on the inverter and enable generator port function in LCD program #39 (Select "GEN").

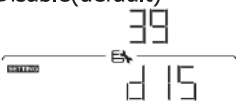
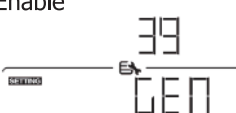
39	Generator port Function	Disable(default) 	If selected, the input of generator port will be disabled.
		Enable 	If selected, generator port will be activated.

After setting, " **APL** " icon will flash on LCD display.

Step 2: You need to turn on the AC output of the inverter. The generator can only be used in battery mode. Once generator port function is activated and power input of generator enter the inverter, " **APL** " icon will be illuminated and input voltage/input frequency will show on the LCD display.

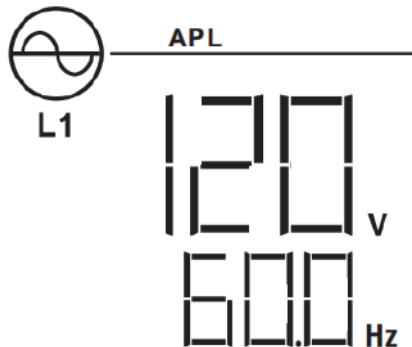

Note:

1. When the generator is in use, the inverter will force the battery to charge.
2. When the generator is in use, the maximum charging current of the inverter will be limited to 100A, and the user can choose a lower charging current by setting LCD program #05.
3. The generator will be used when the power grid is lost. If the power grid is restored, the generator will stop being used.

 1-800-831-9889

 support@richsolar.com

 www.richsolar.com

 5550 Jurupa St, Ontario, CA 91761