

nkuku

HOME AND LIFESTYLE

ASSEMBLY INSTRUCTIONS

ZIRO OUTDOOR LIGHT

ZL1001

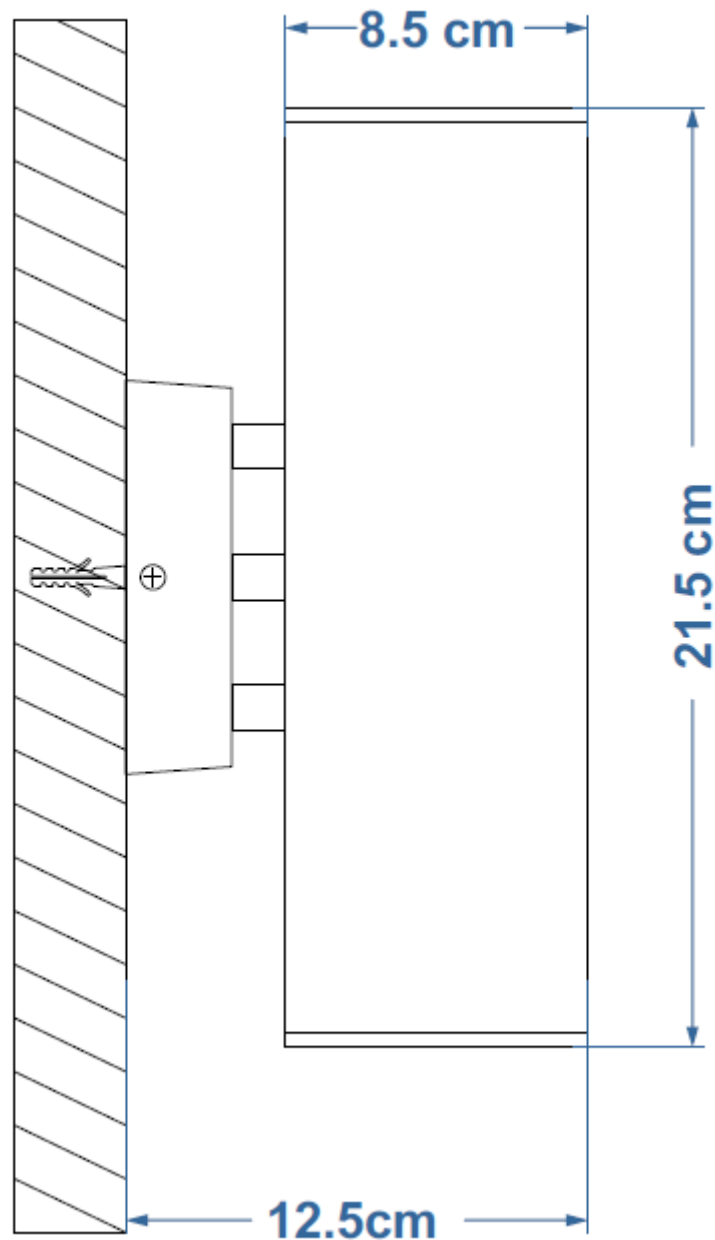

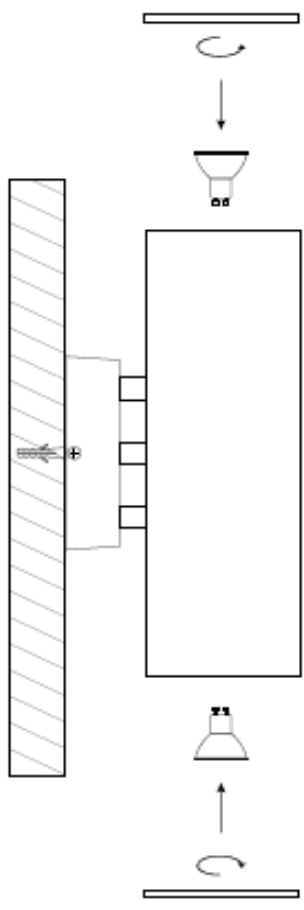
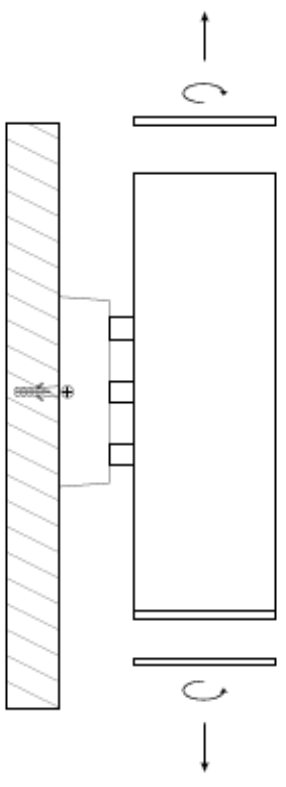
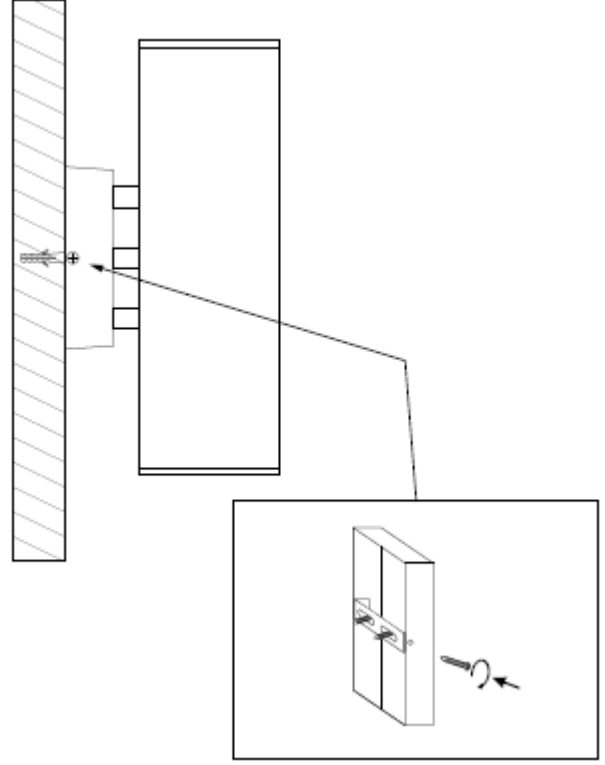
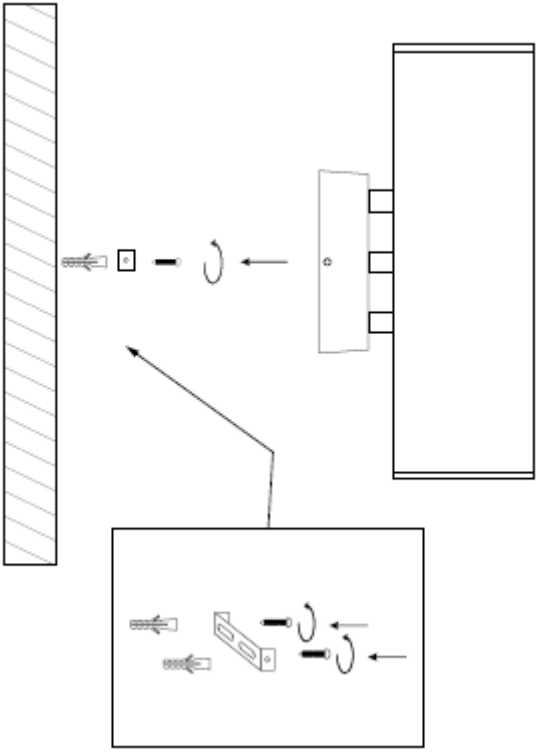

ZIRO OUTDOOR LIGHT

Thank you for purchasing this light.

Please read the instructions carefully before use to ensure safe and satisfactory operation of this product. Please keep these instructions for future reference.

WARNING

It is recommended that this fitting is installed by a qualified electrician. Install in accordance with the IEE wiring regulations and the building regulations. This is a Class I product and must be earthed. To prevent electrocution switch off at mains supply before installing or maintaining this fitting. Ensure no other person can restore the electrical supply without your knowledge. If you are in any doubt please consult a qualified electrician.

This light fitting should be connected to a 5 amp fused circuit. If replacing an existing fitting make a note of the connections. Always use the correct type and wattage bulb. Never exceed the wattage stated. When changing bulbs, always switch off the power and allow the old bulb to cool down before handling. Dispose of used bulbs carefully.

This product is IP44 and suitable for both indoor and outdoor use.

This symbol denotes the minimum distance from the illuminated surface 0.3m.



FIXING INSTRUCTIONS

Make sure you have the following items which are required to install this light fitting:
Small electrical screwdriver, cross head screwdriver and insulation tape.

STEP 1

We recommend that the fuse is withdrawn or the circuit breaker is switched off whilst work is in progress. Before removing the existing fitting, carefully note the position of each set of wires. Where a ring/loop circuit exists there will be a fourth set of wires (usually red) that are not connected to the L. N. or E of fitting. This circuit must be kept together in the 4th terminal of connection block, and insulated from the fitting and other wires. The ring/loop will remain live unless isolated at the mains or circuit breaker regardless of the position of the wall switch.

STEP 2

Having identified the household wiring from your existing light fitting, connect the wiring to connection block in the following way.

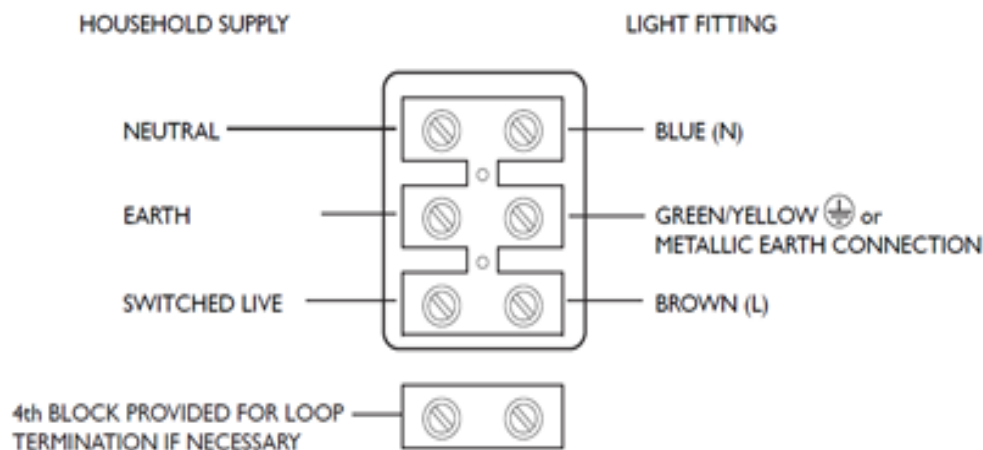

Check that:

- You have correctly identified the house wires.
- The connections are tight.
- No loose strands have been left out of the connection block.

Before fixing, make sure there is a joist at the point of fixing to support the weight of the product. Please also take care to avoid damaging any concealed wiring and pipes. First fix the provided rawl plugs to the wall and make sure they are secure. Then put the screws through the outside holes of ceiling rose, line up with the rawl plugs and screw in place.

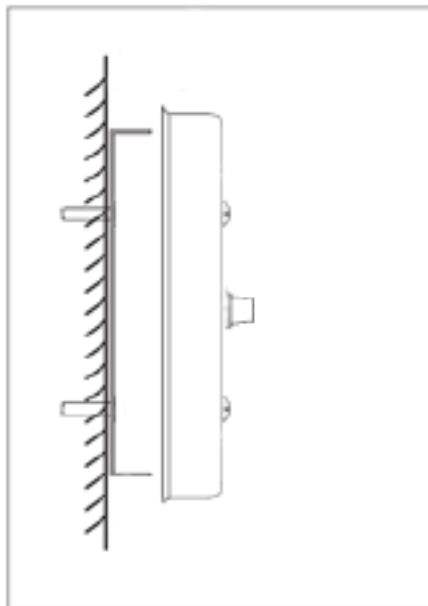

STEP 3

When completed ensure there are no bare or loose strands of wire exposed. Cover all exposed areas of the connection block with 2 layers of insulation tape.

STEP 4

Replace fuse or circuit breaker and switch on. Your light is now ready for use.

STEP 5

Install 2xGU10 bulbs not exceeding a maximum wattage of 8W per bulb.

CARE AND CLEANING

Finish – We recommend cleaning with a soft dry cloth. Do not use abrasive materials as these will damage the finish.

SAFETY INFORMATION

For your safety, switch off the mains supply before changing light bulbs or cleaning.