

FELLOW®

# MEET OPUS™

A get-to-know-you guide  
Guide de familiarisation  
Guía de familiarización  
Ein Leitfaden zum Kennenlernen  
Guida per imparare  
En bli-kjent-guide  
Przewodnik powitalny  
En guide för att lära känna Opus  
Bir tanışma kılavuzu



FELLOW®

# MEET OPUS™

A get-to-know you guide



# ALL THE RIGHT PARTS

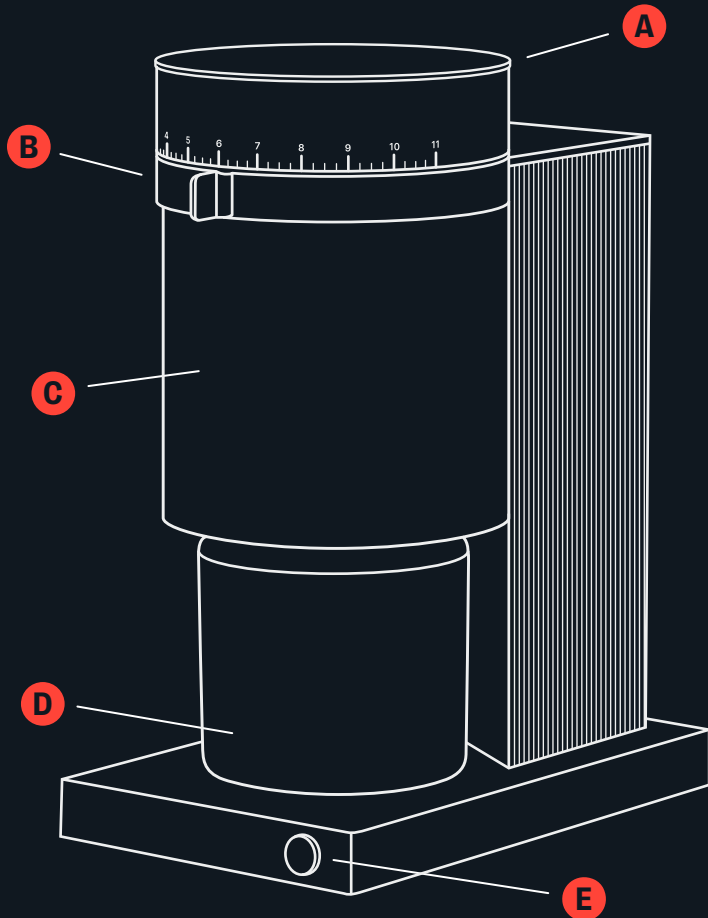

**A** SINGLE DOSE  
LOAD BIN

Sized just right to maximize bean freshness. No scale? Flip the lid over for 20 and 40 gram measuring compartments or fill the lid to the top for 100 grams.

**B** GRIND  
ADJUSTMENT  
RING

Rotate to select grind size from fine (1) to coarse (11). 41 settings in all.

**C** 40 MM  
STAINLESS STEEL  
CONICAL BURRS

With unique cutting geometry and grind adjustment architecture, Opus's six blades precisely grind for espresso and brewed coffee.

**D** MAGNETICALLY  
ALIGNED CATCH

Snaps beneath the chute to ensure grounds fall nice and neat.

**E** POWER BUTTON  
WITH TIMED  
AUTO STOP

Single short press to grind for 30 seconds, double short press for 60 seconds, and triple short press for 90 seconds. Long press to grind for a full 2 minutes. When finished, Opus turns itself off automatically.

# PUT YOUR GRIND AT EASE

Who says you can't have it both ways? With Opus, it's more like 41! We've got a grind setting for every coffee you crave—from the finest espresso to the smoothest cold brew...and everything in between. It's easy to use, easy to clean, and even easier on the eyes. With Opus you can:



**Grind with precision** for every purpose—from a single shot to a 12-cup pot.



**Minimize mess** with our anti-static technology and magnetically aligned catch.



**Grind quickly and quietly**  
More delicious coffee with way less noise.



**Leave no bean behind**  
thanks to low grind retention.



**Clean and calibrate easily**  
no tools required.

No one ever says I have a one track grind.

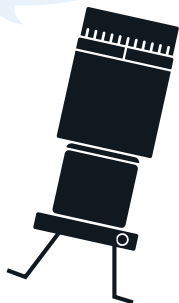

# GRIND SETTINGS

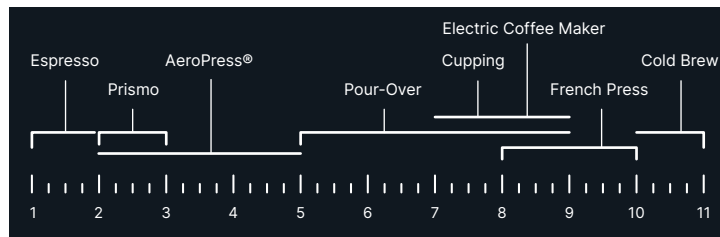

For darker roasts, select a higher number within the recommended grind range.

# RATIO RECOMMENDATIONS

## Coffee dosage guide

- 18 grams → Espresso shot
- 20 grams → Fellow Prismo AeroPress® Attachment
- 25 grams → AeroPress®
- 20 grams → Pour-over for one
- 40 grams → Pour-overs for two
- 60 grams → French press for 3
- 80 grams → Cold brew
- 100 grams → 12-cup batch brew

## Coffee-to-water

- 1:2 → Espresso
- 1:2.5 → Fellow Prismo AeroPress® Attachment
- 1:8 → Cold brew
- 1:14 → French press
- 1:15 → AeroPress®
- 1:16 → Pour-over

# YOUR GUIDE TO GRIND

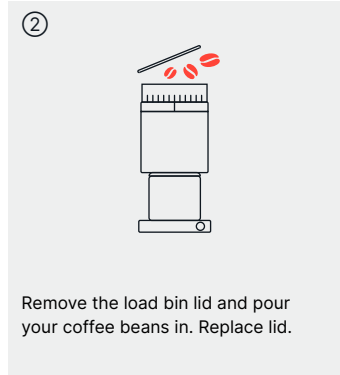
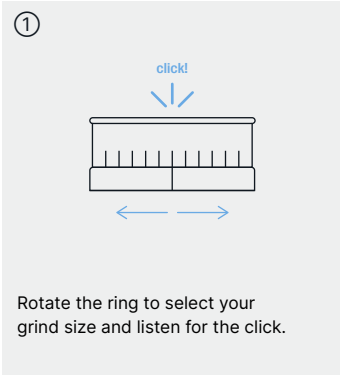

## Espresso

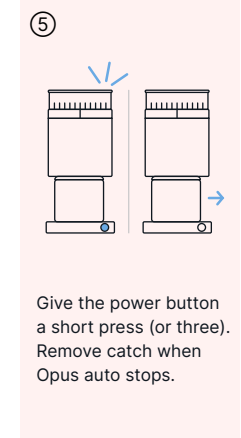
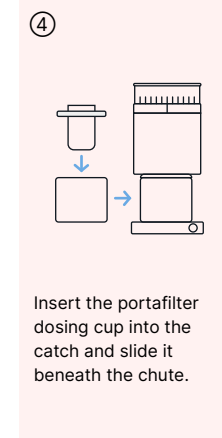
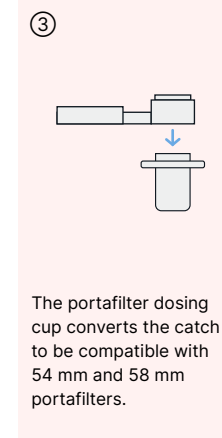

## Brewed Coffee

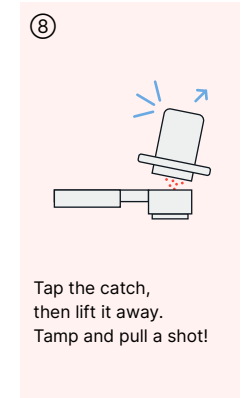
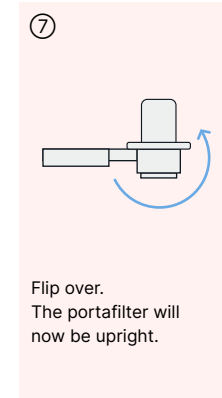
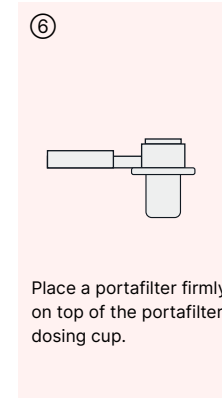
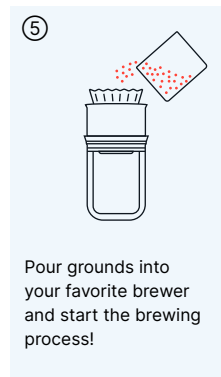
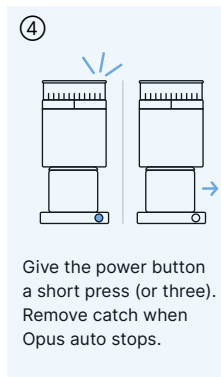
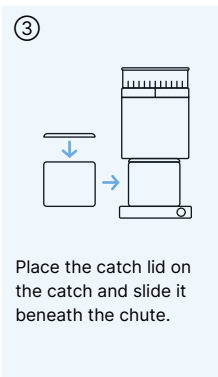

# TIPS + TRICKS

## CLEAN AND CALIBRATE WITH CARE

Treat your Opus right at [Fellowproducts.com/pages/gear-guides](https://fellowproducts.com/pages/gear-guides)

- ① Don't store beans in Opus. Pour beans into the load bin right before grinding. The fresher the coffee, the better the flavor.
- ② Dial in your espresso by using the inner ring to make granular grind adjustments. Visit the gear guide to watch step-by-step instructions: [Fellowproducts.com/pages/gear-guide-opus](https://fellowproducts.com/pages/gear-guide-opus).
- ③ If your brew tastes sour, go a few clicks finer. If your brew tastes bitter, try using a coarser grind.
- ④ Expand your grind at [Fellowproducts.com/pages/gear-guides](https://fellowproducts.com/pages/gear-guides). Find recipes, new brewing methods, and tips from our team of coffee experts.
- ⑤ Time your grind! Just press the power button for different timed grinds:
  - Single short press for 30 seconds
  - Double short press for 60 seconds
  - Triple short press for 90 seconds
  - Press and hold for 1 second to grind for 2 minutesTo stop Opus before the timer expires, simply press the power button during operation. Otherwise, Opus will stop automatically.

FELLOW®

# DÉCOUVREZ OPUS™

## Guide de familiarisation



# TOUT CE QU'IL FAUT

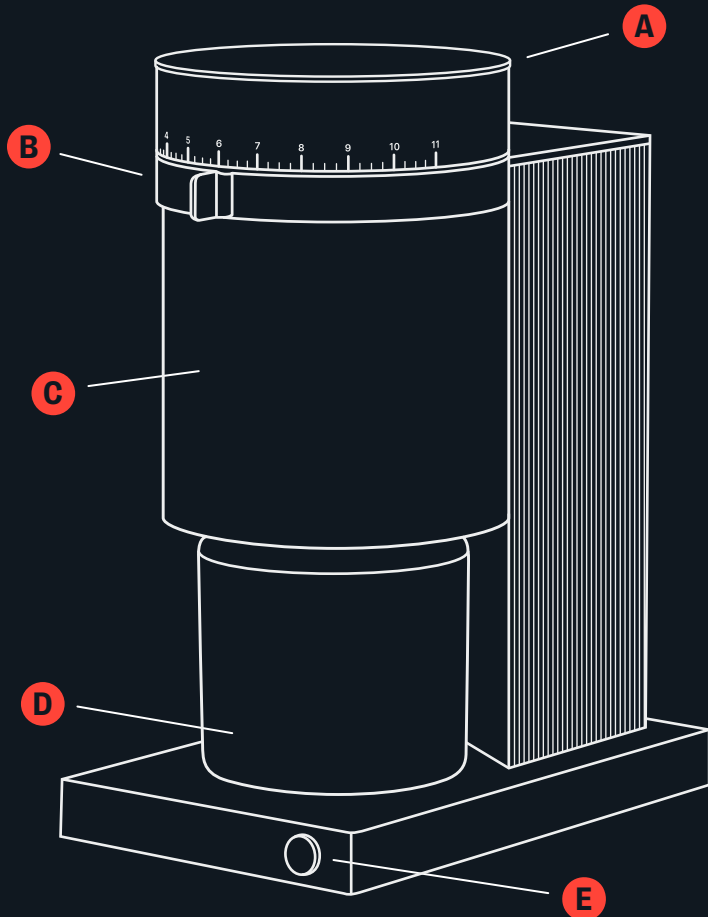

**A** BAC DE CHARGEMENT À DOSE UNIQUE

Ajusté à la taille idéale pour maximiser la fraîcheur des grains. Pas de balance ? Retirez le couvercle pour les quantités de 20 et 40 grammes ou remplissez à ras bord avec le couvercle pour 100 grammes.

**B** BAGUE DE RÉGLAGE DE LA MOUTURE

Tournez pour sélectionner la taille de mouture de fine (1) à grosse (11). 41 réglages au total.

**C** FRAISES CONIQUES EN ACIER INOXYDABLE 40 MM

De forme géométrique unique et de conception architecturale sans pareil, les six lames d'Opus font leur travail avec précision pour les expressos comme pour les cafés infusés.

**D** CONTENANT À ALIGNEMENT MAGNÉTIQUE

Se clipse sous la goulotte pour que les grains de café moulus tombent correctement, sans s'éparpiller.

**E** BOUTON D'ALIMENTATION AVEC ARRÊT AUTOMATIQUE CHRONOMÉTRÉ

Appuyez brièvement une fois pour moulin pendant 30 secondes, appuyez deux fois pour moulin pendant 60 secondes, et trois fois pour moulin pendant 90 secondes. Maintenez appuyé plus longtemps pour moulin pendant deux minutes. Une fois le temps écoulé, Opus s'éteindra automatiquement.

# LA MOUTURE TRANQUILLE

Qui a dit que c'était soit l'un, soit l'autre ? Avec Opus, c'est plutôt 41 possibilités qu'on vous propose ! Un réglage de mouture est disponible pour tous les types de café dont vous rêvez, du meilleur expresso à l'infusion froide la plus douce... sans oublier tout ce qu'il y a autour, bien sûr. C'est facile à utiliser, facile à nettoyer et en plus c'est agréable à regarder. Avec Opus, vous pouvez :



**Moudre votre café avec précision** pour chaque usage, pour une tasse comme pour douze.



**Le faire proprement**, grâce à notre technologie antistatique et notre contenant à alignement magnétique.



**Moudre rapidement et silencieusement.**  
Du café délicieux et beaucoup moins de bruit.



**Ne laisser aucun grain** grâce à la faible rétention de mouture.



**Nettoyer et calibrer facilement.**  
Aucun outil requis.

Une seule mouture ?  
Connais pas !

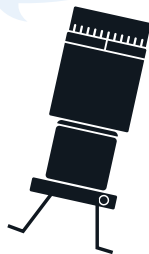

# RÉGLAGES DE MOUTURE

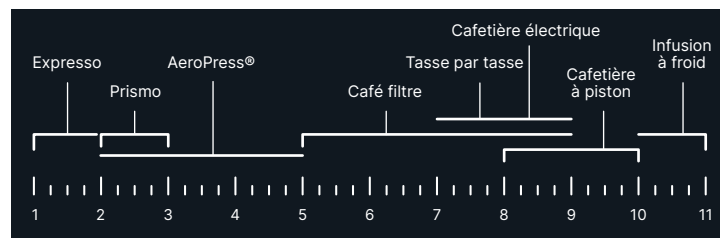

Pour des torrifications plus foncées, sélectionnez un chiffre plus élevé sur la plage des moutures recommandées.

# RECOMMANDATIONS DE RATIO

## Guide de dosage du café

18 grams → Tasse à expresso

20 grams → Embout Fellow  
Prismo AeroPress®

25 grams → AeroPress®

20 grams → Café filtre 1 personne

40 grams → Café filtre 2 personnes

60 grams → Cafetière à piston  
3 personnes

80 grams → Infusion à froid

100 grams → Infusion pour  
12 tasses

## Ratio café/eau

1:2 → Espresso

1:2.5 → Embout Fellow  
Prismo AeroPress®

1:8 → Infusion à froid

1:14 → Cafetière à piston

1:15 → AeroPress®

1:16 → Café filtre



# MOULEZ, VOUS ÊTES GUIDÉS

①

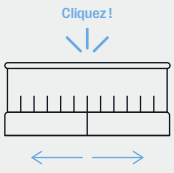

Cliquez!

Tournez la bague pour sélectionner votre taille de mouture jusqu'à entendre le clic.

②



Retirez le couvercle du bac de chargement et versez-y vos grains de café. Remettez le couvercle.

## Brewed Coffee

③

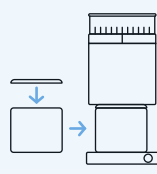

Placez le couvercle du contenant sur celui-ci et glissez-le sous la goulotte.

④

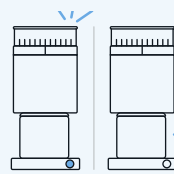

Appuyez une fois (ou trois fois) brièvement sur le bouton d'alimentation. Retirez le contenant après l'arrêt automatique d'Opus.

⑤



Versez les grains de café moulus dans votre cafetière préférée et lancez le processus d'infusion !

## Espresso

③

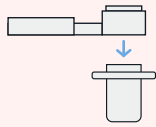

Le gobelet doseur du porte-filtre convertit le contenant pour être compatible avec les porte-filtres de 54 mm et 58 mm.

④

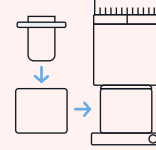

Insérez le gobelet doseur du porte-filtre dans le contenant et glissez-le sous la goulotte.

⑤

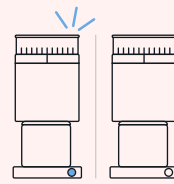

Appuyez une fois (ou trois fois) brièvement sur le bouton d'alimentation. Retirez le contenant après l'arrêt automatique d'Opus.

⑥



Retournez le porte-filtre de manière à le caler fermement sur le dessus du gobelet doseur du porte-filtre.

⑦



Retournez le tout. Le porte-filtre est désormais à l'endroit.

⑧



Tapotez le contenant puis retirez-le. Tassez, et c'est parti !

# TRUCS ET ASTUCES

## NETTOYEZ ET CALIBREZ AVEC SOIN

Apprenez à prendre soin d'Opus sur  
[Fellowproducts.com/pages/gear-guides](https://fellowproducts.com/pages/gear-guides)

- ① Ne stockez pas de grains dans votre Opus. Versez les grains dans le bac de chargement juste avant de les mouler. Plus le café est frais, meilleur il sera.
- ② Ajustez plus précisément la finesse de la mouture pour votre espresso en utilisant l'anneau interne. Veuillez consulter le guide en ligne avec les instructions détaillées : [Fellowproducts.com/pages/gear-guide-opus](https://fellowproducts.com/pages/gear-guide-opus).
- ③ Si votre infusion est aigre, moulez plus fin.  
Si votre infusion est amère, moulez plus gros.
- ④ Découvrez les secrets des moutures sur [Fellowproducts.com/pages/gear-guides](https://fellowproducts.com/pages/gear-guides). Vous y trouverez des recettes, de nouvelles méthodes d'infusion et des conseils de la part de notre équipe d'experts en café.
- ⑤ Il est temps de mouler ! Appuyez simplement sur le bouton d'alimentation pour accéder à différentes moutures chronométrées.
  - Appuyez brièvement une seule fois pour 30 secondes de mouture
  - Appuyez brièvement deux fois pour 60 secondes de mouture
  - Appuyez brièvement trois fois pour 90 secondes de mouture
  - Maintenez appuyé pendant 1 seconde pour mouler pendant 2 minutes.

Pour arrêter Opus avant que le temps ne soit écoulé, appuyez simplement sur le bouton d'alimentation pendant le fonctionnement. Autrement, Opus s'arrêtera automatiquement.

# FELLOW®

# MEET OPUS™

## Guía de familiarización



ESPAÑOL

# TODAS LAS PIEZAS ADECUADAS

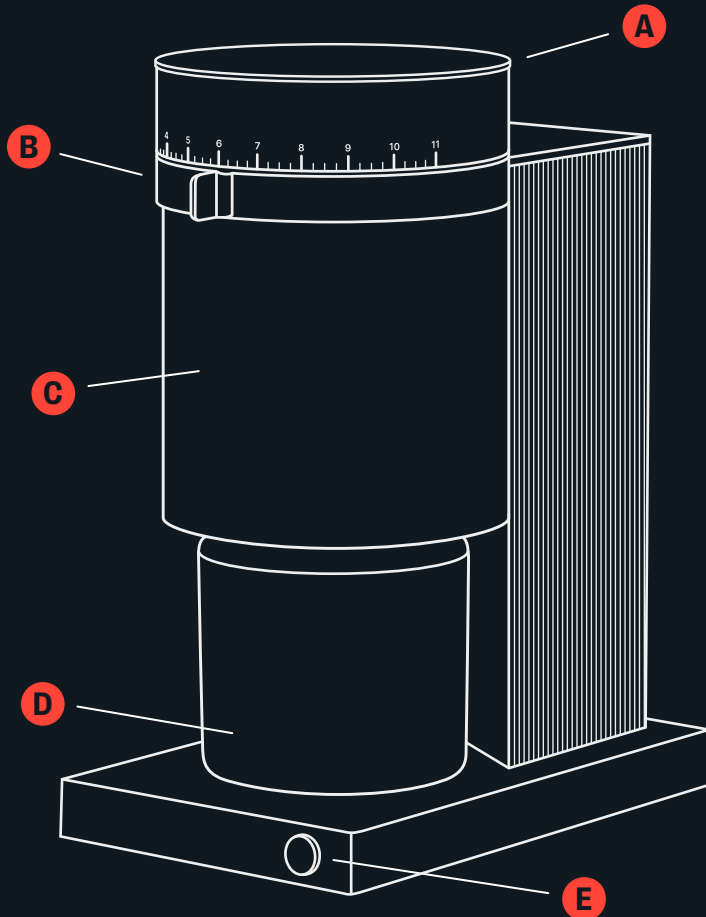

**A** CONTENEDOR DE CARGA DE DOSIS ÚNICA

Tamaño justo para maximizar la frescura de los granos. ¿Sin pesar? Dale la vuelta a la tapa por los compartimentos de medición de 20 y 40 gramos o llena la tapa hasta la parte superior para 100 gramos.

**B** ANILLO DE AJUSTE DE LA MOLIENDA

Gira para seleccionar el tamaño de molienda de fino (1) a grueso (11). 41 ajustes en total.

**C** FRESAS CÓNICAS DE ACERO INOXIDABLE DE 40 MM

Con una forma de corte y una arquitectura de ajuste de molienda únicas, las seis cuchillas de la Opus muelen con precisión para obtener un café expreso o infusionado en frío.

**D** VASO DE ENCAJE MAGNÉTICO

Se acopla bajo el conducto para asegurar que los granos quedan perfectos.

**E** BOTÓN DE ENCENDIDO/APAGADO CON PARADA TEMPORIZADA

Apriétalo brevemente una vez para moler el café durante 30 segundos, dos veces para hacerlo durante 60 segundos y tres para 90 segundos. Si lo dejas apretado durante un poco más, molerá el café durante dos minutos. Cuando acabe, la Opus se apagará automáticamente.

# RELAJATE AL MOLER

¿Quién dice que no puedes tenerlos a ambos? ¡Con Opus, son 41! Tenemos el ajuste de molienda que desees para cada café, desde el mejor expreso a la infusión en frío más suave...y todo lo hay entre medias. Es fácil de usar, fácil de limpiar e incluso más fácil a la vista. Con Opus puedes:



**Moler con precisión** en todo momento, desde un café rápido hasta una jarra para 12 tazas.



**Minimiza el desorden** con nuestra tecnología anti estática y el vaso de encaje magnético.



**Muele rápido y silenciosamente.**  
Café más sabroso con mucho menos ruido.



**No te dejes ningún grano** gracias a la baja retención de molienda.



**Limpia y calibra con facilidad.**  
No se necesitan herramientas.

Nadie podrá decir que solo tiene una pista para moler.

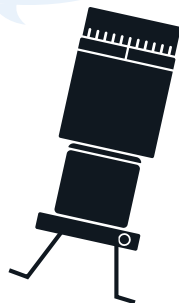

# AJUSTES PARA MOLER



Para tuestes más oscuros, selecciona un número más alto dentro del rango de molienda recomendado.

# RECOMENDACIONES DE PROPORCIONES

## Guía de dosificación de café

- 18 gramos → Café expreso
- 20 gramos → Accesorio Fellow Prismo AeroPress®
- 25 gramos → AeroPress®
- 20 gramos → Cafetera de filtro para uno
- 40 gramos → Cafetera de filtro para dos
- 60 gramos → Cafetera francesa para tres
- 80 gramos → Infusionado en frío
- 100 gramos → Infusión para 12 tazas

## Proporción café/agua

- 1:2 → Expreso
- 1:2.5 → Accesorio Fellow Prismo AeroPress®
- 1:8 → Infusionado en frío
- 1:14 → Cafetera francesa
- 1:15 → AeroPress®
- 1:16 → Cafetera de filtro

# TU GUÍA PARA MOLER



## Expreso

①

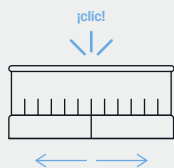

Gira el anillo para seleccionar el tamaño de la molienda y escucha el clic.

②

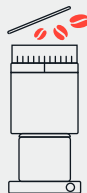

Retira la tapa del contenedor de carga y vierte los granos de café. Vuelve a poner la tapa.

③

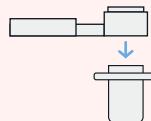

El vaso dosificador portafiltros convierte el vaso en compatible con los portafiltros de 54 mm y 58 mm.

④

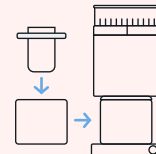

Inserta el vaso dosificador portafiltros en el vaso y deslízalo debajo del conducto.

⑤

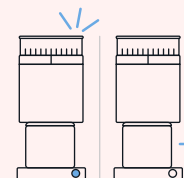

Aprieta brevemente (una vez o tres) el botón de encendido/apagado. Retira el brazo cuando la Opus se detenga automáticamente.

## Café infusionado en frío



③

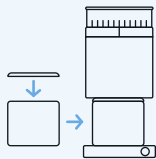

Coloca el vaso retráctil y deslízalo por debajo del conducto.

④

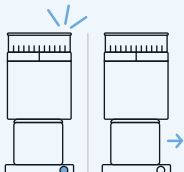

Aprieta brevemente (una vez o tres) el botón de encendido/apagado. Retira el brazo cuando la Opus se detenga automáticamente.

⑤



Vierte los granos en tu infusor favorito y comienza el proceso de elaboración.

⑥

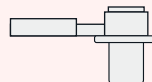

Coloca un portafiltros firmemente sobre la taza dosificadora portafiltros.

⑦

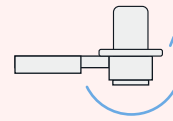

Dale la vuelta. El portafiltros ahora estará en posición vertical.

⑧

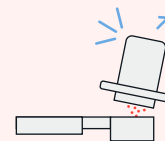

Toque el vaso, luego sácalo. ¡Compacta y prepara una taza!

# SUGERENCIAS Y TRUCOS

CLIMPIA Y CALIBRA  
CON CUIDADO

- ① No almacenes granos en la Opus. Vierte los granos en el contenedor de carga justo antes de moler. Cuanto más fresco sea el café, mejor será el sabor.
- ② Marque su espresso usando el anillo interior para ajustar el grano de la molienda. Visite el manual de instrucciones para ver las instrucciones del paso a paso: [Fellowproducts.com/pages/gear-guide-opus](https://www.fellowproducts.com/pages/gear-guide-opus).
- ③ Si tu infusión sabe agria, muele un poco más fino. Si tu infusión tiene un sabor amargo, prueba a usar una molienda más gruesa.
- ④ Mejora tu molienda en [Fellowproducts.com/pages/gear-guides](https://www.fellowproducts.com/pages/gear-guides). Encuentra recetas, nuevos métodos de infusión y consejos de nuestro equipo de expertos en café.
- ⑤ Mide el tiempo del molido. **APRIETA EL BOTÓN DE ENCENDIDO/ APAGADO PARA ALTERNAR ENTRE LOS DISTINTOS TIEMPOS DE MOLIDO.**
  - Apriétalo una vez para 30 segundos
  - Apriétalo dos veces para 60 segundos
  - Apriétalo tres veces para 90 segundos
  - Déjalo apretado durante 1 segundo para que muele el café durante 2 minutos.

Para detener la Opus antes de que se acabe el tiempo, tan solo tienes que apretar el botón de encendido/apagado mientras esté funcionando. Si no lo aprietas, la Opus se detendrá automáticamente.

FELLOW®

# OPUS™ KENNENLERNEN

Ein Leitfaden  
zum Kennenlernen



DEUTSCH

# ALLE RICHTIGEN TEILE

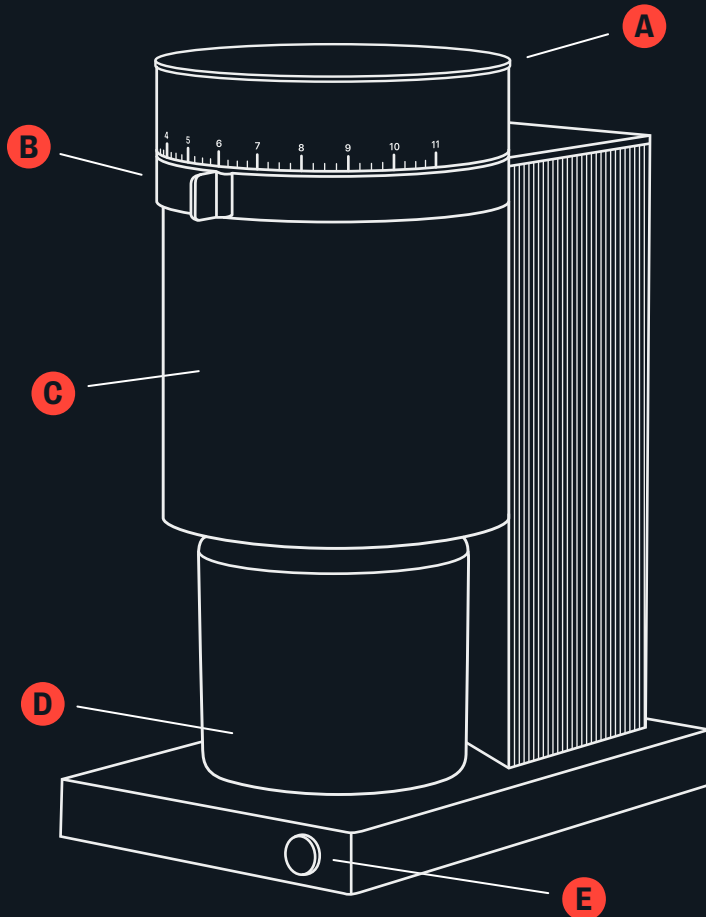

- A** EINZEL-DOSEN-LADE-BUNKER  
Genau richtig dimensioniert, um die Frische der Bohnen zu maximieren. Kein Messgerät? Klappen Sie den Deckel um, um 20 und 40 Gramm zurechtzumessen, oder füllen Sie den Deckel bis zum Rand, um 100 Gramm zu erhalten.
- B** MAHL-GRAD-EINSTELLUNGSRING  
Drehen, um den Mahlgrad von fein (1) bis grob (11) zu wählen. Insgesamt 41 Einstellungen verfügbar.
- C** KONISCHE 40-MM-EDELSTAHL-GRATE  
Egal ob Espresso und Brühkaffee – mit ihrer einzigartigen Schneidgeometrie und Mahlgradeinstellung mahlen die sechs Klingen der Opus präzise Ihrem Wunsch entsprechend.
- D** MAGNETISCH AUSGERICHTETER AUFFANGBEHÄLTER  
Die Schnappverschlüsse am Mahlgutschacht sorgen dafür, dass der Kaffeesatz schön und sauber fällt.
- E** EINSCHALTKNOPF MIT ZEITLICH ABGESTIMMTEM AUTOMATISCHEN STOPP  
Einmal kurz drücken, um 30 Sekunden lang zu mahlen, zweimal kurz drücken für 60 Sekunden und dreimal kurz drücken für 90 Sekunden. Lange drücken, um zwei Minuten lang zu mahlen. Danach schaltet sich Opus automatisch aus.

# WAHRER MAHLSPASS

Wer sagt, dass man nicht beides haben kann? Bei Opus sind es gar 41 Optionen! Wir haben eine Mahlgradeinstellung für jeden Kaffee, den Sie gerne hätten – vom feinsten Espresso bis zum sanftesten Cold Brew ... und alles dazwischen. Einfach zu bedienen, leicht zu reinigen und dazu noch eine wahre Augenweide. Mit der Opus können Sie:



**Mahlen mit Präzision** für jeden Zweck – von einem einzelnen Shot bis zu einer 12-Tassen-Kanne



Dank unserer antistatischen Technologie und dem magnetisch ausgerichteten Auffangbehälter der **Unordnung in Ihrer Küche endlich Adieu sagen.**



**Ihren Kaffee schnell und leise mahlen.** Mehr köstlicher Kaffee, weniger Lärmbelastung.



Dank der Mahlgrutrückhaltung **bleibt keine Bohne zurück.**



**Leicht zu reinigen und zu kalibrieren.** Keine Werkzeuge erforderlich.

Nein, natürlich bin ich nicht voreingenommen ...

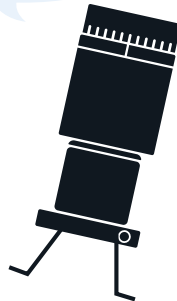

# MAHLEINSTELLUNGEN

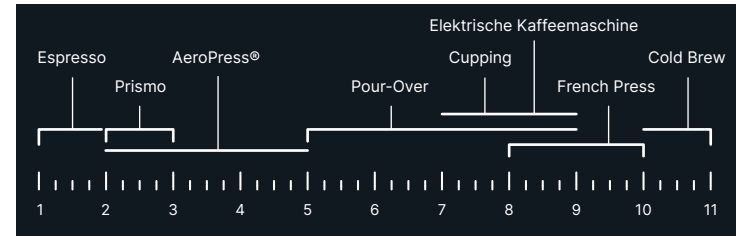

Für dunklere Röstungen wählen Sie eine höhere Zahl innerhalb des empfohlenen Mahlgradbereichs.

# VERHÄLTNISEMPFEHLUNGEN

## Kaffee-Dosierung-Tipps

18 Gramm → Espresso Shot

20 Gramm → Fellow Prismo  
AeroPress® Zusatz

25 Gramm → AeroPress®

20 Gramm → Pour Over für Einen

40 Gramm → Pour Overs für Zwei

60 Gramm → French Press für Drei

80 Gramm → Cold Brew

100 Gramm → Für 12 Tassen

## Kaffe-Wasser-Verhältnis

1:2 → Espresso

1:2,5 → Fellow Prismo  
AeroPress® Zusatz

1:8 → Cold brew

1:14 → French press

1:15 → AeroPress®

1:16 → Pour-over



# IHR MAHL-LEITFADEN

①

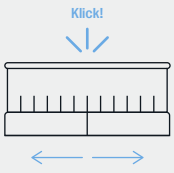

Klick!

Um den gewünschte Mahlgrad auszuwählen, drehen Sie den Ring bis Sie ein „Klick“ hören.

②



Nehmen Sie den Deckel des Füllbehälters ab und geben Sie die Kaffeebohnen hinein. Setzen Sie den Deckel wieder auf.

## Gebrühter Kaffee

③

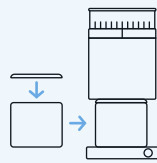

Setzen Sie den Verschlussdeckel auf den Auffangbehälter und schieben Sie ihn unter den Mahlgutschacht.

④

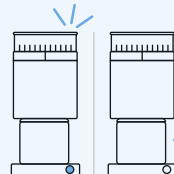

Drücken Sie einmal (oder dreimal) kurz auf den Einschaltknopf. Entfernen Sie die Halterung, sollte Opus von sich aus stoppen.

⑤



Füllen Sie den Kaffeesatz in Ihre Lieblingsbrühmaschine und starten Sie den Brühvorgang!

## Espresso

③

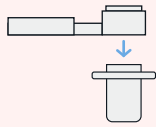

Der Siebträger-Dosierbecher macht den Auffangbehälter mit 54-mm- und 58-mm-Siebträgern kompatibel.

④

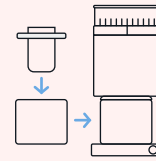

Setzen Sie den Dosierbecher des Siebträgers in den Auffangbehälter ein und lassen Sie ihn unterhalb des Mahlgutschachts einrasten.

⑤

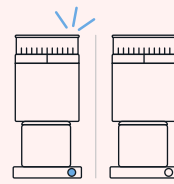

Drücken Sie einmal (oder dreimal) kurz auf den Einschaltknopf. Entfernen Sie die Halterung, sollte Opus von sich aus stoppen.

⑥

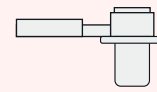

Setzen Sie einen Siebträger fest auf den Siebträger-Dosierbecher.

⑦

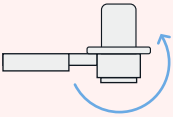

Umdrehen. Der Siebträger steht nun aufrecht.

⑧



Tippen Sie auf den Auffangbehälter und entfernen Sie ihn. Tampen und Kaffee rinnen lassen!

# TIPPS UND TRICKS

SORGFÄLTIG REINIGEN  
UND KALIBRIEREN

Ihre Opus richtig warten – siehe  
[Fellowproducts.com/pages/gear-guides](https://fellowproducts.com/pages/gear-guides)

- ① Bewahren Sie in Ihrer Opus keine Kaffeebohnen auf. Schütten Sie die Bohnen erst unmittelbar vor dem Mahlen in den Bohnenbehälter. Je frischer der Kaffee, desto besser der Geschmack!
- ② Um Ihren Espresso zu kalibrieren, verwenden Sie den inneren Ring, den Mahlgrad anzupassen. Besuchen Sie die Gear-Guide-Website, um sich Schritt-für-Schritt-Anleitungen anzusehen: [Fellowproducts.com/pages/gear-guide-opus](https://fellowproducts.com/pages/gear-guide-opus).
- ③ Wenn Ihr Kaffee sauer schmeckt, stellen Sie den Mahlgrad ein wenig feiner ein. Wenn Ihr Kaffee bitter schmeckt, versuchen Sie es mit einem gröberen Mahlgrad.
- ④ Erweitern Ihres Mahlgrads –siehe [Fellowproducts.com/pages/gear-guides](https://fellowproducts.com/pages/gear-guides). Hier finden Sie Rezepte, neue Zubereitungsmethoden und Tipps von unserem Kaffeexperten-Team!
- ⑤ Mahlen nach Zeituhr. Drücken Sie einfach den Einschaltknopf je nach Mahl-Zeituhr.
  - Einmal kurz für 30 Sekunden drücken
  - Zweimal kurz für 60 Sekunden drücken
  - Dreimal kurz für 90 Sekunden drücken
  - 1 Sekunde gedrückt halten, um 2 Minuten lang zu mahlen.Um Opus anzuhalten, bevor die Zeit abgelaufen ist, einfach auf den Anschaltknopf drücken. Ansonsten hört Opus automatisch auf.

FELLOW®

SCOPRI  
OPUS™

Guida per imparare



ITALIANO

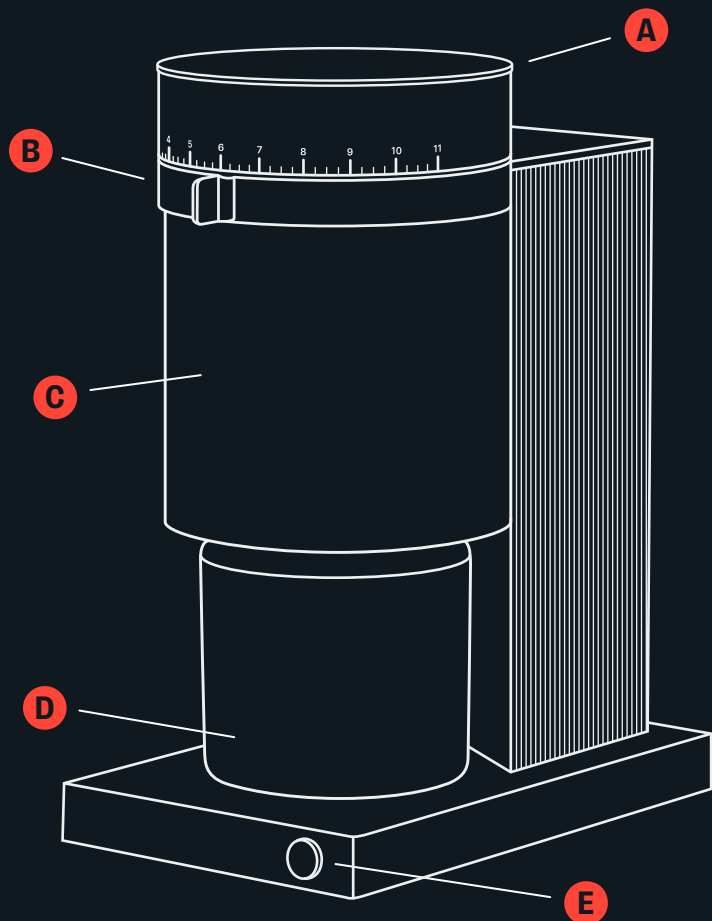

# COMPONENTI

- A** **CONTENITORE DI CARICO MONODOSE** Dimensioni ideali per preservare la freschezza dei chicchi. Non occorre una bilancia. Capovolgi il coperchio per gli scomparti di misurazione da 20 e 40 g o riempi il coperchio fino all'orlo per 100 g.
- B** **GHIERA DI REGOLAZIONE DELLA MACINATURA** Ruota per selezionare la macinatura da fine (1) a grossa (11). 41 impostazioni in tutto.
- C** **MACINE CONICHE IN ACCIAIO INOX DA 40 MM** Grazie all'esclusiva geometria di taglio e all'architettura di regolazione della macinatura, la precisa macinatura a sei lame di Opus ti regalerà un espresso o un caffè filtro.
- D** **RACCOGLITORE AD ALLOGGIAMENTO MAGNETICO** Si aggancia sotto il piano per garantire che i fondi cadano in modo pulito e ordinato.
- E** **PULSANTE DI ACCENSIONE CON ARRESTO AUTOMATICO TEMPORIZZATO** Una singola pressione breve per macinare per 30 secondi, una doppia pressione breve per 60 secondi e una tripla pressione breve per 90 secondi. Premere a lungo per macinare per due minuti. Al termine, Opus si spegne in automatico.

# PER UNA MACINATURA IMPECCABILE

Chi ha detto che non si possono avere entrambe le cose? Con Opus, puoi averne 41! Offriamo un'impostazione per una macinatura adatta a qualsiasi tipo di caffè, dall'espresso più raffinato, all'infusione a freddo più dolce...oltre a tutto il resto. È facile da usare, facile da pulire e bella da vedere. Con Opus puoi:



Soddisfare le esigenze di ogni palato con **una macinatura a precisione**, per noi stessi o fino a 12 invitati.



**Ridurre al minimo il disordine** grazie alla tecnologia antistatica e al raccogliitore ad alloggiamento magnetico.



**Macinare rapidamente e silenziosamente.** Gustare un caffè più delizioso con meno rumore.



Risparmiare: grazie alla **bassa ritenzione di macinatura**, non si perde un solo chicco.



**Pulire e calibrare facilmente.** Nessun strumento richiesto.

Chi ha detto solo "ristretto"?

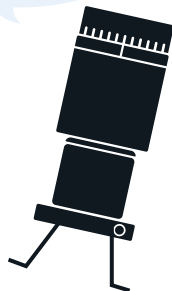

# IMPOSTAZIONI DI MACINATURA

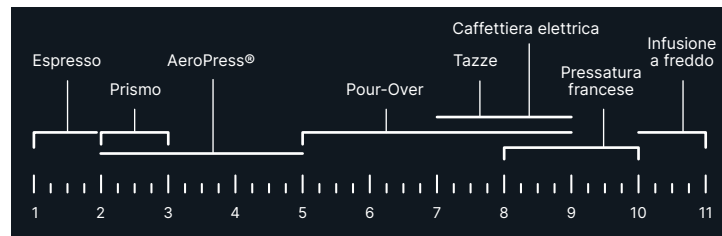

Per una tostatura più scura, seleziona un numero più alto all'interno della gamma di macinatura consigliata.

# CONSIGLI SULLE DOSI

## Guida al dosaggio del caffè

- 18 g → Espresso
- 20 g → Accessorio Fellow Prismo AeroPress®
- 25 g → AeroPress®
- 20 g → Pour-over per uno
- 40 g → Pour-over per due
- 60 g → Pressatura francese per 3
- 80 g → Infusione a freddo
- 100 g → Erogazione per 12 tazze

## Caffè-acqua

- 1:2 → Espresso
- 1:2.5 → Accessorio Fellow Prismo AeroPress®
- 1:8 → Infusione a freddo
- 1:14 → Pressatura francese
- 1:15 → AeroPress®
- 1:16 → Pour-over

# GUIDA ALLA MACINAZIONE

## Espresso

①

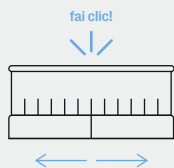

Ruota la ghiera per selezionare la dimensione della macinatura e aspetta il clic.

②



Rimuovi il coperchio del contenitore di carico e versa i chicchi di caffè. Rimetti il coperchio.

③

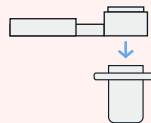

La tazza di dosaggio del portafiltro fa sì che il raccoglitore sia compatibile con portafiltri da 54 mm e da 58 mm.

④

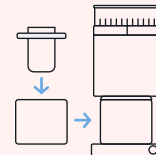

Inserisci la tazza di dosaggio del portafiltro nel raccoglitore e falla scorrere sotto lo scivolo.

⑤

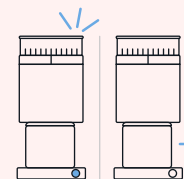

Premere brevemente una volta (o tre) il pulsante di accensione. Rimuovi il raccoglitore quando Opus si ferma automaticamente.

## Caffè filtro

③

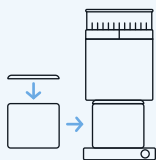

Place the catch lid on the catch and slide it beneath the chute.

④

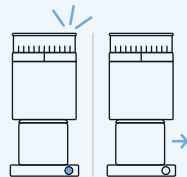

Premere brevemente una volta (o tre) il pulsante di accensione. Rimuovi il raccoglitore quando Opus si ferma automaticamente.

⑤

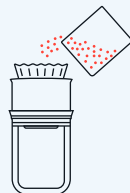

Pour grounds into your favorite brewer and start the brewing process!

⑥

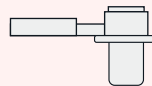

Posiziona saldamente un portafiltro sulla tazza di dosaggio del portafiltro.

⑦

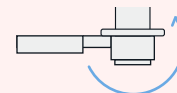

Capovolgilo. Il portafiltro si trova ora in posizione verticale.

⑧

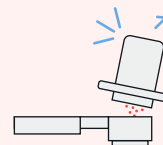

Afferra il raccoglitore, quindi sollevalo. Tira ed estrai.

# CONSIGLI + TRUCCHI

PULISCI E CALIBRA  
CON CURA

Scopri come prenderti cura di  
Opus su [fellowproducts.com/  
pages/gear-guides](https://fellowproducts.com/pages/gear-guides)

- ① Non conservare i chicchi in Opus. Versa i chicchi nel contenitore di carico subito prima della macinatura. Più il caffè è fresco, più il sapore è buono.
- ② Personalizza il tuo espresso utilizzando la ghiera interna per regolare la macinatura a seconda della grana desiderata. Visita la guida al prodotto per vedere le istruzioni passo passo: [fellowproducts.com/pages/gear-guide-opus](https://fellowproducts.com/pages/gear-guide-opus).
- ③ Se il caffè ha un sapore aspro, si consiglia di aumentare il grado di finezza di qualche clic. Se il caffè ha un sapore amaro, prova a usare una macinatura più grossa.
- ④ Approfondisci la ricerca su [fellowproducts.com/pages/gear-guides](https://fellowproducts.com/pages/gear-guides). Scopri ricette, nuovi metodi di preparazione e consigli da parte del nostro team di esperti di caffè.
- ⑤ Cronometra il tempo di macinazione! È sufficiente premere il pulsante di accensione per ottenere una macinatura temporizzata.
  - Singola pressione breve per 30 secondi
  - Doppia pressione breve per 60 secondi
  - Tripla pressione breve per 90 secondi
  - Tenere premuto per 1 secondo per macinare per 2 minutiPer arrestare Opus prima della scadenza del timer, è sufficiente premere il pulsante di accensione durante il funzionamento. In caso contrario, Opus si arresterà automaticamente.

FELLOW®

MØT  
OPUS™

En bli-kjent-guide



# ALLE DE RETTE DELENE

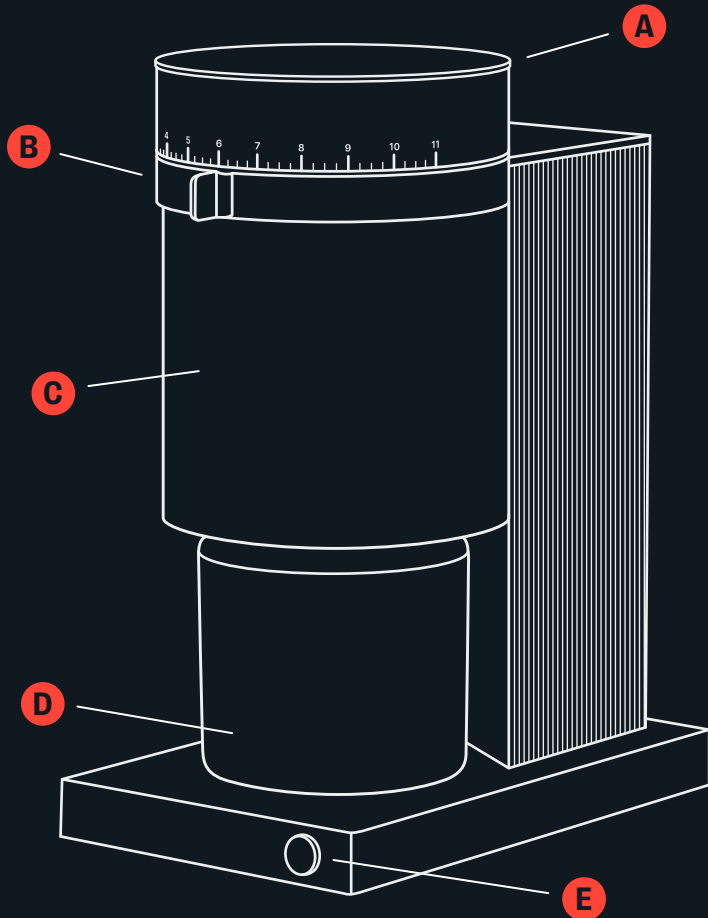

**A** ENKELTDOSE  
INNLASTINGS-  
BEHOLDER

Størrelse som akkurat er passe stor for å maksimere bønnens friskhet. Har du ikke en vekt? Snu lokket for 20 og 40 grams målerom eller fyll beholderen til topps for 100 gram.

**B** KVERNENS  
JUSTERINGSRING

Roter for å velge kvernestørrelse fra fin (1) til grov (11). 41 innstillinger i alt.

**C** 40 MM KONISKE  
KVERNBLADER I  
RUSTFRITT STÅL

Med unik kuttegeometri og kvernejusteringsarkitektur kverner Opus' seks blader nøyaktig for espresso og brygget kaffe.

**D** MAGNETISK  
JUSTERT  
OPPSAMLER

Klikkes under rennen for å sikre at gruten faller pent og rent.

**E** STRØMKNAPP  
MED AUTOMATISK  
STYRT STOPP

Enkelt kort trykk for å kverne i 30 sekunder, dobbelt kort trykk for 60 sekunder og trippel kort trykk for 90 sekunder. Trykk lenge for å kverne i hele to minutter. Opus slår seg av automatisk når den er ferdig.

# GJØR KVERNINGEN ENKEL

Hvem sier at du ikke kan få det på begge måter? Med Opus er det mer som 41! Vi har en kverninnstilling for hver kaffetype du ønsker – fra den fineste espressoen til den mykeste kaldbryggingen – og alt imellom. Den er enkel å bruke, enkel å rengjøre, og enda enklere å se på. Med Opus kan du:



**Kverne med presisjon** for alle formål – fra én enkelt shot til 12-koppers kanne.



**Minimere søl** med vår antistatiske teknologi og magnetiske justerte oppsamler.



**Kverne raskt og stille.** Få mer deilig kaffe med mye mindre støy.



Unngå at bønner går til spille gjennom den **lave kvernretensjonen**.



**Enkelt rengjøre og kalibrere.** Ingen verktøy er nødvendig.

Ingen kan si at jeg har en ensporig kvern.

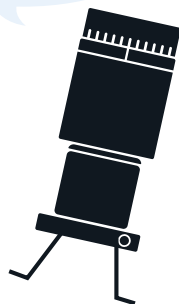

# KVERNEINNSTILLINGER

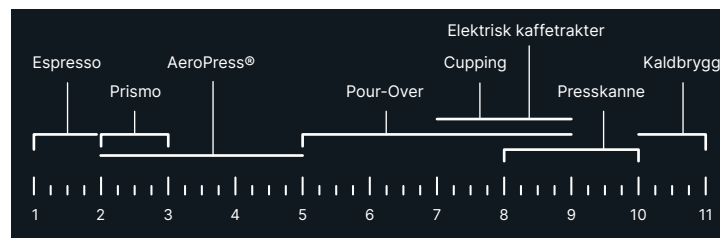

For mørkere brenning, velg et høyere tall innenfor det anbefalte kverneområdet.

# FORHOLDSANBEFALINGER

## Veiledning for kaffedosering

- 18 gram → espressoshot
- 20 gram → AeroPress®
- 25 gram → AeroPress®
- 20 gram → pour-Over for én
- 40 gram → pour-Over for to
- 60 gram → presskanne for tre
- 80 gram → kaldbrygg
- 100 gram → 12-koppers brygg

## Kaffe-til-vann

- 1:2 → Espresso
- 1:2.5 → Fellow Prismo AeroPress®-tilbehør
- 1:8 → kaldbrygg
- 1:14 → presskanne
- 1:15 → AeroPress®
- 1:16 → Pour-Over



# DIN VEILEDNING TIL KVERNING

## Espresso

①

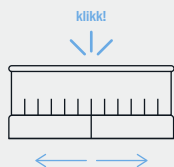

Roter ringen for å velge kvernstørrelse og lytt etter klikket.

②

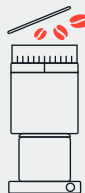

Ta av lokket og hell i kaffebønner. Sett på lokket.

③

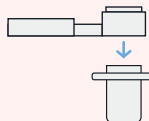

Doseringskoppen for portafilter konverterer kverneresultatet slik at det passer med 54 mm og 58 mm portalfiltre.

④

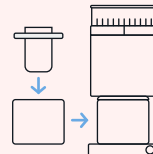

Sett inn doseringskoppen for portafilter i oppsamleren og skyv den under rennen.

⑤

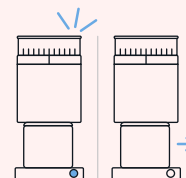

Gi strømknappen et kort trykk (eller tre). Ta ut oppsamleren når Opus stopper automatisk.

## Brygget kaffe

③

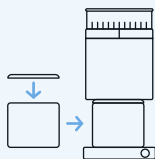

Sett sperreløkket på oppsamleren og skyv det under rennen.

④

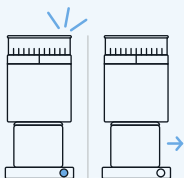

Gi strømknappen et kort trykk (eller tre). Ta ut oppsamleren når Opus stopper automatisk.

⑤



Hell den kvernede kaffen i trakteren og start bryggeprosessen!

⑥

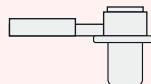

Plasser en filterholder på toppen av doseringskoppen for filterholderen.

⑦

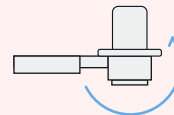

Vend. Filterholderen vil nå være stående.

⑧

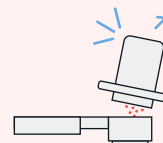

Trykk på oppsamleren, og løft den deretter vekk. Press og lag en shot!

# TIPS + TRIKS

## RENGJØR OG KALIBRER MED VARSOMHET

Gi Opus-produktet ditt rett  
behandling ved å lese deg opp  
[Fellowproducts.com/pages/gear-guides](https://fellowproducts.com/pages/gear-guides)

- ① Ikke oppbevar bønner i Opus. Hell bønner i beholderen rett før kverning. Jo ferskere kaffe, jo bedre smak.
- ② Still inn og juster hvor finmalt espresso du vil ha med den innerste ringen. Gå til brukermanualen for trinnvis veiledning til bruk: [Fellowproducts.com/pages/gear-guide-opus](https://fellowproducts.com/pages/gear-guide-opus).
- ③ Hvis brygget ditt smaker surt, kan du prøve med en litt finere kverning. Hvis brygget ditt smaker bittert, kan du prøve med en litt grovere kverning.
- ④ Få mest mulig ut av kverningen ved å finne informasjon på [Fellowproducts.com/pages/gear-guides](https://fellowproducts.com/pages/gear-guides). Finn oppskrifter, nye bryggemetoder og tips fra teamet av kaffeeksperter.
- ⑤ Ta tiden på kverningen din! Bare trykk på strømknappen for forskjellige timede kverninger.
  - Enkelt kort trykk for 30 sekunder
  - Dobbelt kort trykk for 60 sekunder
  - Trippel kort trykk for 90 sekunder
  - Trykk og hold i 1 sekund for å kverne i 2 minutter.For å stoppe Opus før tidsuret utløper, trykk helt enkelt på strømknappen under drift. Ellers stopper Opus automatisk.

FELLOW®

# POZNAJCIE OPUS™

Przewodnik powitalny



# WSZYSTKIE WŁAŚCIWE CZĘŚCI

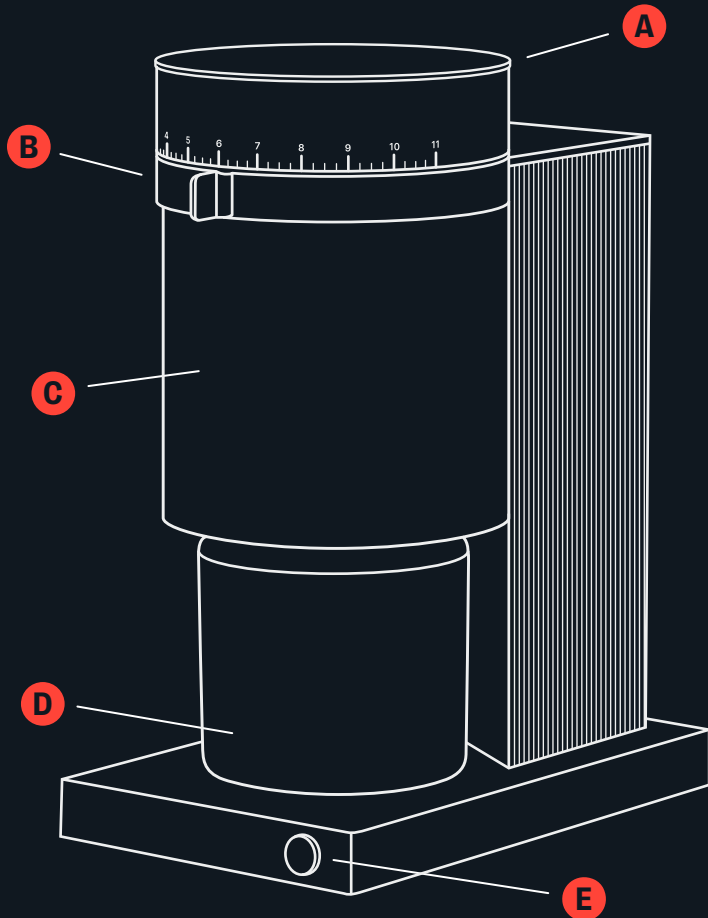

**A** ZBIORNIK NA  
POJEDYNCZĄ  
PORCJĘ KAWY

Rozmiar sprzyja użyciu zawsze świeżego ziarna. Nie masz wagi? Odwróć pokrywę i wsyń ziarno do oznaczeń 20 lub 40 gramów, lub wypełnij pokrywę do końca, aby odmierzyć 100 gramów.

**B** PIERŚCIEN  
REGULACJI  
MIELENIA

Obróć, aby zmienić stopień mielenia: od drobnego (1) do gruboziarnistego (11). Łącznie 41 ustawień.

**C** STOŻKOWE ŻARNA  
40 MM ZE STALI  
NIERDZEWNEJ

Unikalna geometria powierzchni tnących oraz regulacja grubości mielenia sprawiają, że sześć ramion żarna Opus mieli kawę odpowiednio pod espresso i przelewowe metody parzenia.

**D** MAGNETYCZNY  
POJEMNIK NA  
ZMIELONĄ KAWĘ

Ustawia się pod zsydem tak, aby zmielona kawa trafiła bezpośrednio do niego.

**E** AUTOMATYCZNE,  
ZAPROGRAMOWANE  
CZASOWO  
ZATRZYMANIE  
MIELENIA

Naciśnij przycisk raz, aby mielić przez 30 sekund, dwa razy, aby mielić przez 60 sekund lub 3 razy, aby mielić przez 90 sekund. Naciśnij i przytrzymaj przycisk, aby mielić przez pełne 2 minuty. Po upływie czasu, Opus wyłączy się automatycznie.

# MIELENIE MOŻE BYĆ PROSTE

Kto powiedział, że trzeba wybierać pomiędzy dwiema opcjami? Opus proponuje ich aż 41! Mamy ustawienie mielenia do każdej kawy, jakiej możesz zapragnąć – od espresso aż po cold brew... i wszystko pomiędzy! Opus jest łatwy w użyciu, łatwy w czyszczeniu i przyjemny dla oka. Dzięki młynkowi Opus możesz:



**Precyzyjnie mielić kawę** do do wszystkich metod parzenia - od pojedynczego espresso po zaparzacze o pojemności 12 filiżanek.



**Ograniczyć bałagan do minimum** dzięki technologii antystatycznej i magnetycznemu pojemnikowi na ziarno.



**Mielić szybko i cicho.** Więcej pysznej kawy i mniej hałasu.



**Być pewnym, że żadne ziarno nie umknie** dzięki niskiej retencji.



**Czyścić i kalibrować w łatwy sposób.** Bez użycia narzędzi.

Nikt nigdy nie powie, że umiesz mielić tylko w jeden sposób.

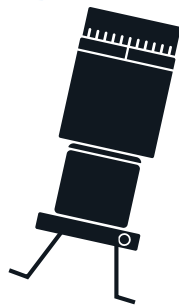

# USTAWIENIA MIELENIA

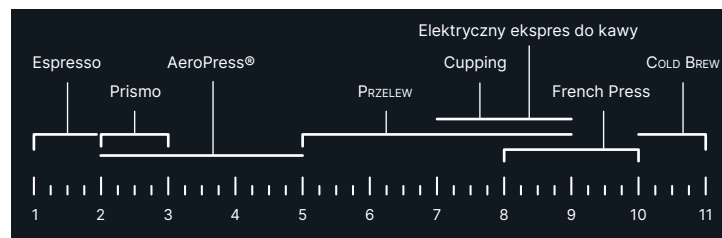

W przypadku ciemniejszych ziaren należy wybrać wyższą liczbę w ramach zalecanego ustawienia mielenia.

# ZALECENIA DOTYCZĄCE PROPORCJI

## Dozowanie kawy

- 18 g → Espresso
- 20 g → Nakładka Fellow Prismo do AeroPress®
- 25 g → AeroPress®
- 20 g → Przelew dla jednej osoby
- 40 g → Przelew dla dwóch osób
- 60 g → French Press dla 3 osób
- 80 g → Cold Brew
- 100 g → Ekspres przelewowy na 12 filiżanek

## Proporcja kawy do wody

- 1:2 → ESPRESSO
- 1:2.5 → Nakładka Fellow Prismo do AeroPress®
- 1:8 → Cold Brew
- 1:14 → ZAPARZACZ FRENCH PRESS
- 1:15 → AEROPRESS®
- 1:16 → PRZELEW

# TWÓJ PRZEWODNIK PO MIELENIU

## Espresso

①

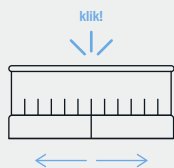

Obracaj pierścieniem, aby wybierać odpowiedni poziom mielenia. Nasłuchuj kliknięcia jako potwierdzenia prawidłowego ustawienia.

②



Zdejmij pokrywę pojemnika i wsyp do niego ziarna kawy. Załóż pokrywę z powrotem.

③

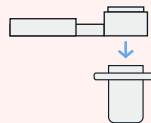

Zbiornik dozujący do portafiltera pasuje zarówno do średnicy 54 mm, jak i 58 mm.

④

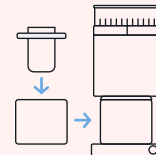

Umieść zbiornik dozujący do portafiltera w zbiorniku i umieść całość pod zsysem.

⑤

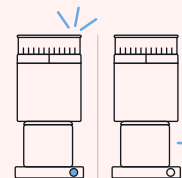

Wciśnij przycisk zasilania. Wyjmij pojemnik ze zmieloną kawą po zatrzymaniu pracy młynka.

## Kawa parzona

③

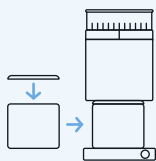

Umieść pokrywę zbiornika na zbiorniku i wsuń go pod zsyse.

④

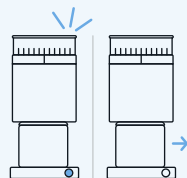

Wciśnij przycisk zasilania. Wyjmij pojemnik ze zmieloną kawą po zatrzymaniu pracy młynka.

⑤

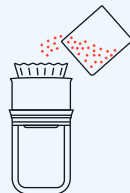

Wsyp zmieloną kawę do ulubionego zaparzacza i zaparz tak, jak lubisz.

⑥

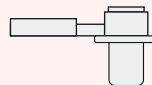

Nałóż portafiltr na zbiornik dozujący.

⑦

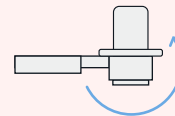

Przekręć całość do góry nogami a portafiltr będzie pełny.

⑧

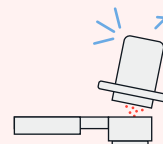

Zdejmij zbiornik z portafiltera, ubij zmieloną kawę i zapnij portafiltr do ekspresu.

# WSKAZÓWKI + SZTUCZKI

ZACHOWAJ OSTROŻNOŚĆ PRZY  
CZYSZCZENIU I KALIBRACJI

- ① Nie zostawiaj niezmielonych ziaren w młynku. Za każdym razem wsypuj ziarna do młynka tuż przed ich mieleniem. Im świeższa kawa, tym lepszy smak.
- ② Przygotuj odpowiednie dla siebie espresso używając wewnętrznego pierścienia, pozwala on wybrać odpowiednią grubość mielenia. Możesz zobaczyć jak zrobić to krok po kroku w naszym przewodniku: [fellowproducts.com/pages/gear-guide-opus](https://fellowproducts.com/pages/gear-guide-opus).
- ③ Jeżeli napar ma kwaśny smak, należy zmienić ustawienie mielenia na drobniejsze. Jeżeli napar ma gorzki smak, należy zmienić ustawienie mielenia na bardziej gruboziarniste.
- ④ Dowiedz się, jak mielić lepiej na: [fellowproducts.com/pages/gearguides](https://fellowproducts.com/pages/gearguides). Znajdziesz tam przepisy, nowe metody parzenia oraz wskazówki od naszych specjalistów.
- ⑤ Mierz czas! Wystarczy nacisnąć przycisk zasilania, aby uzyskać różne czasy mielenia:
  - Pojedyncze krótkie naciśnięcie - mielenie przez 30 sekund
  - Podwójne krótkie naciśnięcie - mielenie przez 60 sekund
  - Potrójne krótkie naciśnięcie - mielenie przez 90 sekund
  - Naciśnij i przytrzymaj przycisk zasilania przez 1 sekundę, aby mielić nieustannie przez 2 minutyAby zatrzymać mielenie przed upływem zaprogramowanego czasu, po prostu naciśnij przycisk zasilania podczas pracy. W przeciwnym razie młynek zatrzyma się automatycznie.

FELLOW®

MÖT  
OPUS™

En guide för att lära  
känna Opus



# INGA ONÖDIGA DELAR

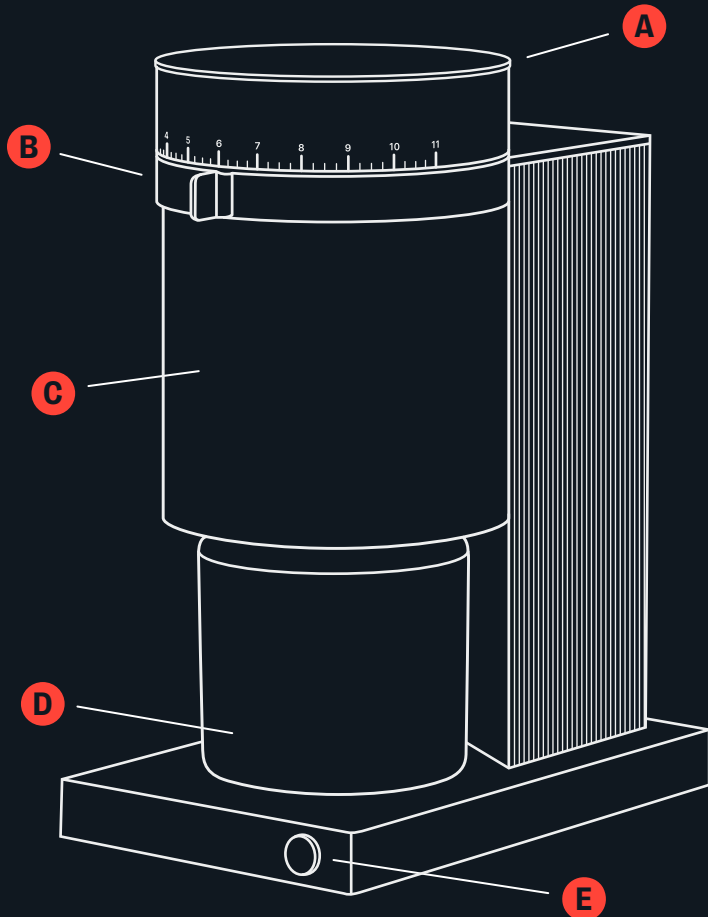

## A ENKELDOSERING

Storleken är exakt anpassad för maximalt färska bönor. Ingen skala? Fäll upp locket för 20- och 40-gramsfacken eller fyll upp locket helt för 100 gram.

## B MALNINGSINSTÄLLNINGSRING

Vrid för att välja malningsgrad, från fin (1) till grov (11) (totalt 41 inställningar).

## C 40 MM KONISKT SKÄR AV ROSTFRITT STÅL

Med unik malningsgeometri och justeringsmekanism maler Opus sex skärblad bönor för espresso och bryggkaffe.

## D MAGNETISKT INRIKTAD MALNINGSBEHÅLLARE

Hakas fast under utkastet och gör att kaffet faller ner snyggt och prydligt.

## E STRÖMKNAPP MED AUTOMATISK AVSTÄNGNING

Tryck ett kort tryck för att mala i 30 sekunder, tryck kort två gånger för 60 sekunder och tre korta tryck för 90 sekunder. Tryck ett längre tryck för två hela minuter. När det är klar stänger Opus sedan av sig automatiskt.

# GÖR DET ENKELT ATT MALA KAFFET

Vem har sagt att kaffe inte kan tillagas på olika sätt? Med Opus är det hela 41 sätt! Opus har en inställning för varje kaffesmak, från den mest finmalda espresso till det god-aste iskaffet ... och allt däremellan. Den är lätt att an-vända, rengöra och dessutom snygg. Med Opus kan du:



**Mala med precision** för varje ändamål, allt från en enkel espresso till en kanna med 12 koppar bryggkaffe.



**Göra det enkelt** med vår antistatiska teknik och magnetiskt inriktade malningsbehållare.



**Mala snabbt och tyst.** Utsökt kaffe med betydligt lägre ljudnivå.



**Lämnar inga böror omalda** tack vare noggrann finmalning.



**Enkel rengöring och inställning.** Inga verktyg behövs.

Ingen menar ju att det bara finns ett möjligt sätt att mala kaffe på.

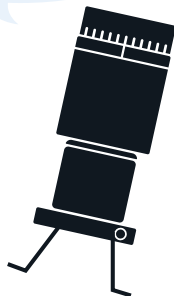

# MALNINGSINSTÄLLNINGAR

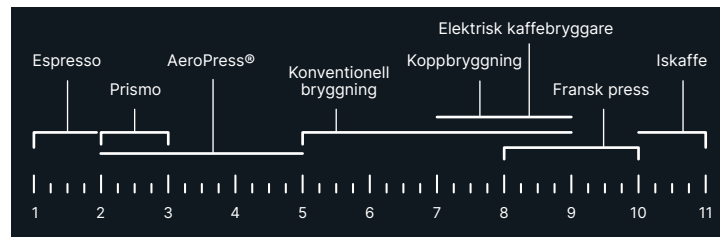

Välj ett högre värde inom rekommenderat inställningsintervall om kaffet är mörkare rostat.

# REKOMMENDERAD DOSERING

## Kaffedosering

- 18 gram → Enkel espresso
- 20 gram → Fellow Prismo AeroPress® tillbehör
- 25 gram → AeroPress®
- 20 gram → Bryggning för en
- 40 gram → Bryggning för två
- 60 gram → Fransk press för tre
- 80 gram → Iskaffe
- 100 gram → Bryggning av 12 koppar

## Kaffe/vatten

- 1:2 → ESPRESSO
- 1:2.5 → FELLOW PRISMO AEROPRESS® TILLBEHÖR
- 1:8 → ISKAFFE
- 1:14 → FRANSK PRESS
- 1:15 → AEROPRESS®
- 1:16 → KONVENTIONELL BRYGGNING



# DIN MALNINGSGUIDE

①

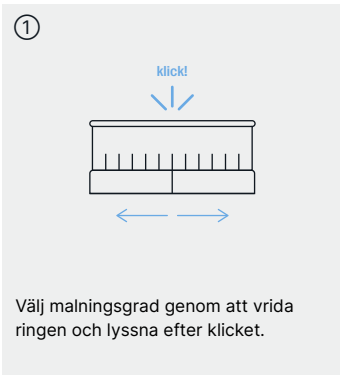

Välj malningsgrad genom att vrida ringen och lyssna efter klicket.

②



Ta bort locket på bönbehållaren och håll i kaffebönorna. Sätt tillbaka locket.

## Bryggkaffe

③

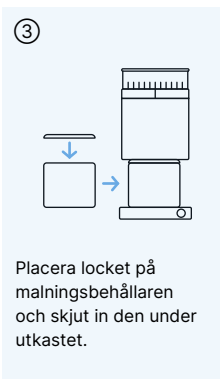

Placera locket på malningsbehållaren och skjut in den under utkastet.

④



Tryck ett kort tryck på strömknappen (eller tre). Ta bort behållaren när Opus har stannat.

⑤



Häll kaffet i bryggaren och starta bryggningen!

## Espresso

③

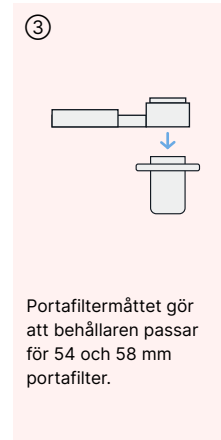

Portafiltermättet gör att behållaren passar för 54 och 58 mm portafilter.

④

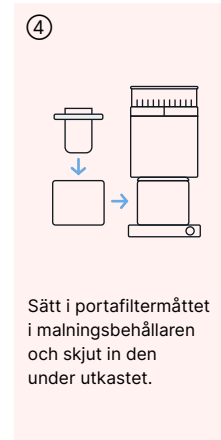

Sätt i portafiltermättet i malningsbehållaren och skjut in den under utkastet.

⑤

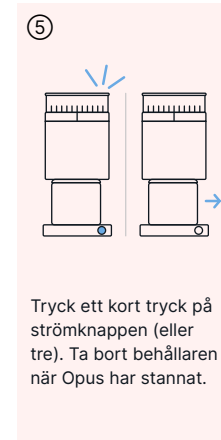

Tryck ett kort tryck på strömknappen (eller tre). Ta bort behållaren när Opus har stannat.

⑥

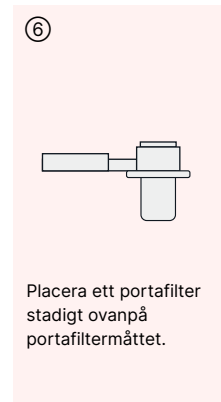

Placera ett portafilter stadigt ovanpå portafiltermättet.

⑦

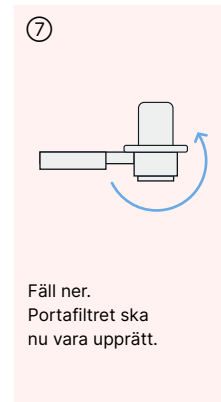

Fäll ner. Portafiltret ska nu vara upprätt.

⑧



Knacka på malningsbehållaren och lyft bort den. Fyll och ta ut en espresso!

# TIPS

## RENGÖR OCH KALIBRERA NOGGRANT

Rätt skötsel av din Opus:  
[Fellowproducts.com/pages/gear-guides](https://fellowproducts.com/pages/gear-guides)

- ① Förvara inte kaffeböner i Opus. Häll bönorna i laddningsbehållaren före malning. Ju färskare kaffe desto bättre smak.
- ② Anpassa din espresso med hjälp av den inre ringen för att justera malningen. Besök vår handledningsguide för att se steg-för-steg-instruktioner: [Fellowproducts.com/pages/gear-guide-opus](https://fellowproducts.com/pages/gear-guide-opus).
- ③ Om kaffet smakar surt: välj en lite finare malning. Om kaffet smakar beskt kan du prova en lite grövre malning.
- ④ Gör mer av malningen på [Fellowproducts.com/pages/gear-guides](https://fellowproducts.com/pages/gear-guides). Hitta recept, upptäck nya bryggmetoder och tips från våra kaffeexperter
- ⑤ Håll koll på malningstiden! Tryck helt enkelt på strömknappen för olika långa malningstider.
  - Ett enkelt kort tryck för 30 sekunder
  - Två korta tryck för 60 sekunder
  - Tre korta tryck för 90 sekunder
  - Tryck och håll in i en sekund för att mala i två minuter.För att stanna Opus innan timern gått ut trycker du helt enkelt på strömknappen när maskinen körs. Annars kommer Opus att stanna automatiskt.

FELLOW®

# OPUS™ ile TANIŞIN

Bir tanışma kılavuzu



# TÜM DOĞRU PARÇALAR

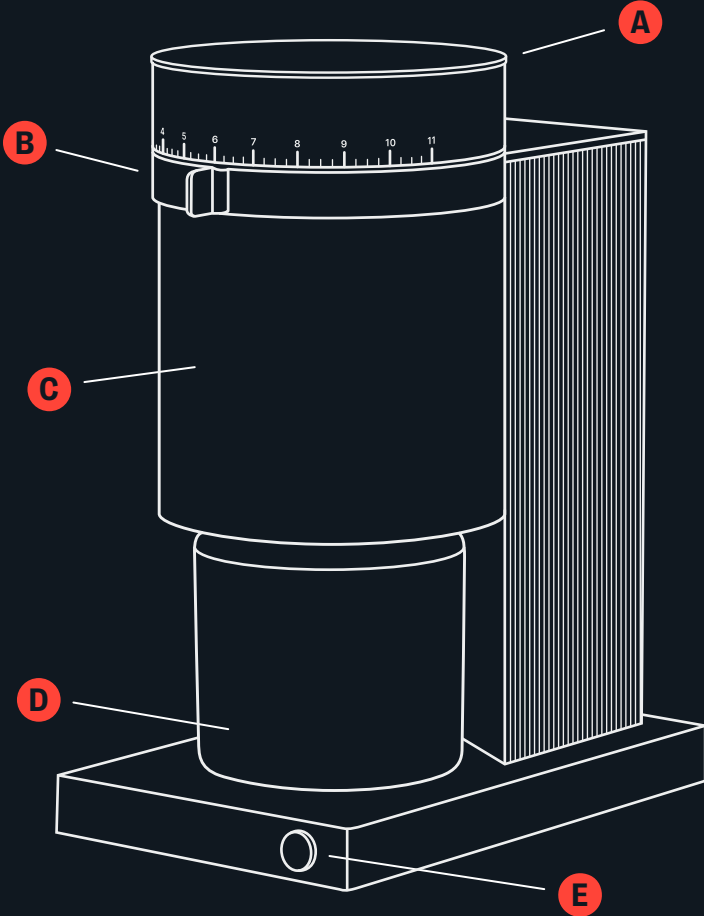

## A TEK DOZLUK YÜKLEME KABI

Kahve çekirdeğinin tazeliğini en üst düzeyde tutmak için boyutları tam olarak ayarlanmıştır. Tartı yok mu? 20 veya 40 gramlık ölçüm bölmeleri için kapağı kaldırın veya 100 gram için kapağı tepeleme doldurun.

## B ÖĞÜTME AYAR HALKASI

Öğütme boyutunu inceden (1) kalına seçmek için döndürün (11). Her şey için 41 ayar var.

## C 40 MM PASLANMAZ ÇELİK KONİK İÇ BIÇAKLAR

Benzer kesim geometrisi ve öğütme ayarı mimarisiyle, Opus'un altı bıçağı kahve çekirdeklerini espresso ve demlenmiş kahve için hassas biçimde öğütür.

## D MANYETİK OLARAK AYARLANAN BÖLME

Öğütülen çekirdeklerin rahat ve düzenli şekilde olmaları için boşaltma oluğunun altına geçirilir.

## E ZAMAN AYARLI OTOMATİK DURDURMA İLE GÜÇ DÜĞMESİ

Öğütmek için 30 saniye tek kısa basma, 60 saniye çift kısa basma ve 90 saniye üç kısa basma. Öğütmek için tam iki dakika uzun basma. Bittiğinde, Opus kendi kendini kapatacaktır.

# ÖĞÜTME İŞLEMİNİZDE KAFANIZ RAHAT OLSUN

Her ikisine de sahip olamayacağınızı kim söylüyor? Opus ile ise 41'ine de sahip olabilirsiniz. Tutkuyla bağlı olduğunuz her kahve için bir öğütme ayarımız var—en ince espressodan en yumuşak içimli soğuk demleme kahveye kadar ve arasındakileri saymıyoruz bile. Kullanımı, temizlemesi kolaydır ve hatta göze daha da hoş gelir. Opus ile yapabileceğiniz:



**Her amacınız için hassasiyetle öğütün**—tek atımdan 12 bardaklık demliğe kadar.



Anti statik teknolojimiz ve manyetik olarak ayarlanan haznemiz **ile dağınıklığı en aza indirir.**



**Çabucak ve sessizce öğütün.** Daha az gürültüyle çok daha lezzetli kahve.



Düşük öğütme tutucu ayarı **sayesinde hiçbir çekirdeği kaçırmayın.**



**Kolaylıkla temizleyin ve kalibre edin.** Hiçbir alet gerekmez.

Bugüne hiç kimse tek öğütme seçeneğim var demedi.

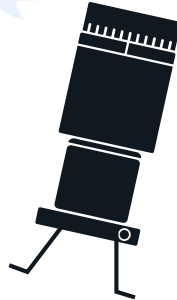

# ÖĞÜTME AYARLARI

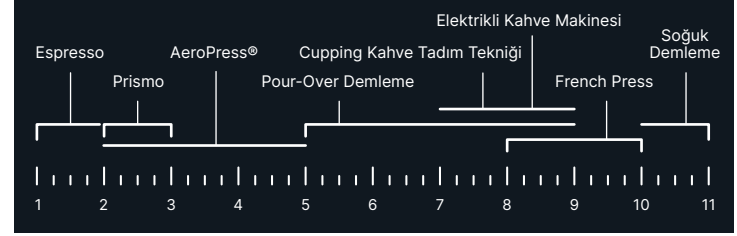

aha koyu kavrulmuş çekirdekler için, önerilen öğütme aralığı içinde daha yüksek bir sayı seçin.

# ORAN ÖNERİLERİ

## Kahve dozu kılavuzu

- 18 gram → Tek espresso
- 20 gram → Fellow Prismo AeroPress® Ataşmanı
- 25 gram → AeroPress®
- 20 gram → Bir kişilik Pour-over demleme
- 40 gram → İki kişilik Pour-over demleme
- 60 gram → 3 kişilik French press
- 80 gram → Soğuk demleme
- 100 gram → 12 bardaklık toplu demleme

## Kahve/su oranı

- 1:2 → Espresso
- 1:2,5 → Fellow Prismo AeroPress® Ataşmanı
- 1:8 → Soğuk demleme
- 1:14 → French press
- 1:15 → AeroPress®
- 1:16 → Pour-over demleme

# ÖĞÜTME KILAVUZUNUZ



## Espresso

①

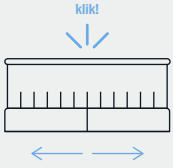

Öğütme boyutunu seçmek için halkayı döndürün ve klinik sesini duyun.

②

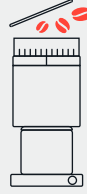

Yükleme kabı kapağını çıkarın ve kahve çekirdeklerini dökün. Kapağı değiştirin.

③

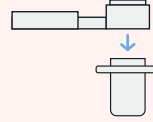

Portafiltre doz bardağı hazneyi 54 mm ve 58 mm portafiltreler ile uyumlu olması için dönüştürür.

④

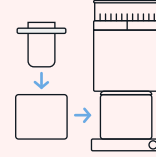

Manyetik olarak ayarlanan hazneye portafiltre doz bardağını yerleştirin ve boşaltma oluğunun altına kaydırın.

⑤

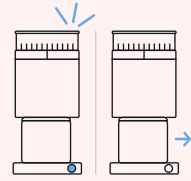

Güç düğmesine kısa süreli (veya üç kez) basın. Opus otomatik olarak durduğunda, hazneyi çıkarın.

## Demlenmiş Kahve



③

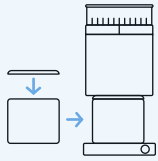

Manyetik olarak ayarlanan hazne kapağını yerleştirin ve boşaltma oluğunun altına kaydırın.

④

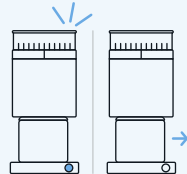

Güç düğmesine kısa süreli (veya üç kez) basın. Opus otomatik olarak durduğunda, hazneyi çıkarın.

⑤

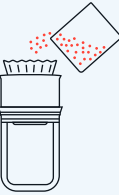

Öğütülen çekirdekleri favori demleyicinize dökün ve demleme işlemini başlatın!

⑥

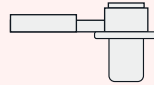

Portafiltre doz bardağının üzerine bir portafiltreyi sıkıca yerleştirin.

⑦

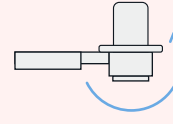

Ters çevirin. Portafiltre şimdi üst tarafta olacaktır.

⑧

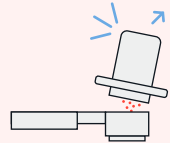

Hazneye hafifçe vurun ve ardından kaldırın. Bastırıp sıkıştırın ve çekin. İşte tek içiminiz hazır!

# İPUÇLARI + TÜYÖLAR

## ÖZENLE TEMİZLEYİN VE KALİBRE EDİN

Fellowproducts.com/pages/  
gear-guides adresinden  
Opus'unuza iyi bakın.

- ① Kahve çekirdeklerini Opus içinde saklamayın. Çekirdekleri öğütmenin hemen öncesinde yükleme kabına doldurun. Kahve ne kadar tazeyse, tadım o kadar iyi olur.
- ② Granül öğütme ayarlarını yapmak için iç halkayı kullanarak espresso'nuzu ayarlayın. Adım adım talimatları izlemek için ekipman kılavuzuna bakın: [Fellowproducts.com/pages/gear-guide-opus](https://fellowproducts.com/pages/gear-guide-opus).
- ③ Demlemeniz acımsı bir tada sahipse, birkaç tık daha ince bir ayarı deneyin. Kahvenizin tadı biraz acıysa, daha kalın bir öğütme ayarını deneyin.
- ④ [Fellowproducts.com/pages/gear-guides](https://fellowproducts.com/pages/gear-guides) adresinden öğütme ile ilgili bilgilerinizi arttırın Tarifler, yeni demleme yöntemlerini ve kahve uzmanları ekibimizden ipuçlarını bulun.
- ⑤ Öğütmenizi zamanlayın! Farklı zaman ayarlı öğütmeler için sadece güç düğmesine basın.
  - 30 saniye için tek kısa basma
  - 60 saniye için çift kısa basma
  - 90 saniye için üç kısa basma
  - 2 dakika öğütmek için 1 saniye basın ve basılı tutun.Zamanlayıcının süresi dolmadan Opus'u durdurmak için, yapmanız gereken tek şey çalışma sırasında güç düğmesine basmak. Aksi takdirde, Opus otomatik olarak duracaktır.



[www.fellowproducts.com](http://www.fellowproducts.com) | [@fellowproducts](https://twitter.com/fellowproducts)

789-00027 B