



bonsaii

6 In 1 Thermal Laminator

Instruction Manual

Model: L418-C

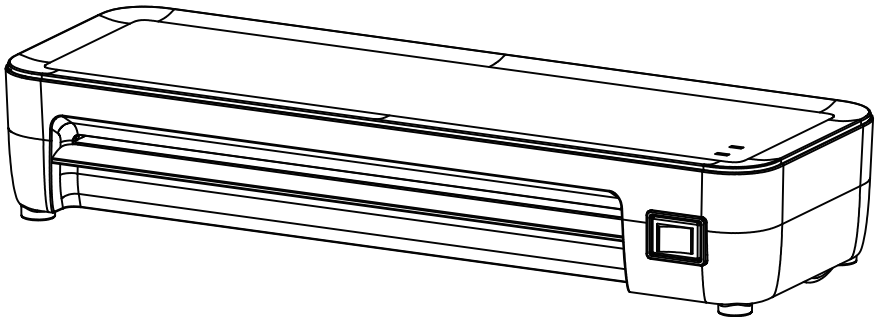

**THIS INSTRUCTION BOOKLET CONTAINS IMPORTANT SAFETY INFORMATION.
PLEASE READ AND KEEP IT FOR FUTURE REFERENCE.**

Please give us a chance to make it right and do better!
Contact our friendly customer service department for help first.
Replacements for missing or damaged parts will be shipped.

Customer Service:

✉ : customer-care@bonsaii.com

☎ : 1-844-728-6917



IMPORTANT!

1. Please read all instructions carefully and retain instructions for future reference.
2. Read through each step carefully and follow the proper order.
3. Please place this machine on a flat and stable surface place, please be careful and don't tip the machine over .
 - * In case the machine is broken and cannot be used as normal.
4. The device should be set up as close as possible to an easily accessible wall socket.
5. Dangerous, please do not disassemble, modify or repair the machine in any way on your own.
 - * To avoid electric shock, hurting or accidental injury.
6. When move the machine, or no need to use the machine for a certain period of time ,Please kindly make the machine under OFF status and unplug.
 - * To avoid fire accident or electric shock.
7. Please don't use inflammable liquids, gases, water and cleaner to clean the machine.
 - * To avoid fire accident or electric shock.
8. Please don't use the machine in a very high temperature, very humidity and very heavy dust environment .
 - *To avoid fire accident, electric shock or machine malfunction
9. Please do not damage or process the power cables, or do not place heavy objects on the cables.
 - * To avoid fire accident or, hurting or electric shock
10. If abnormal conditions such as smoke or odor occurred, please disconnect the power and stop using it immediately.
 - * To avoid fire accident or electric shock
11. Please do not use if the laminator or the power cable is damaged or defective
 - * To avoid fire accident or electric shock

IMPORTANT SAFETY INTRODUCTIONS BEFORE FIRST USE

Safety



This product is intended for indoor use only.



Hot surfaces – burn hazard.



Caution - Moving Parts!

- This equipment is not intended for use by children. Avoid the media feed opening with the hands, clothing or hair. Unplug this equipment when not in use for an extended period. Hazardous moving parts is in this equipment. Keep body parts away from moving parts.
- This equipment is not suitable for use in locations where children are likely to be present.
- When first used, a burning smell may be emitted as residue from the manufacturing process is being burnt off, this is completely normal.
- Place the product on a dry and level surface. The product must be freely accessible from all sides.
- The product is not intended to be used continuously for commercial purposes. The product is only designed for normal domestic use. The product should be used for no longer than two hours at a time and then allowed to cool for 30 minutes.
- Never use the product outdoors, in humid environments or close to water or other liquids.
- Make sure to never spill liquids onto the product.
- Never try to open the housing, repair or modify the product in any way.
- All repairs must be carried out by qualified service technicians using original spare parts.
- Only use laminating film of the correct size.
- Certain parts of the product become hot during use. Do not touch any hot parts, as burn injuries may result.
- This product must not be used by children without adult supervision.
- Always unplug the product from the wall socket when it is not in use.
- Never let children play with the product.
- Never insert any foreign objects into the product. Only laminating film compatible with the product may be inserted.
- Be careful that no foreign objects are accidentally inserted into the product during use.

- The product must only be plugged into the related power outlet.
- Make sure that the power outlet used is easily accessible in case the product needs to be unplugged quickly.
- Never lay the mains lead over hot surfaces, sharp edges or corners. Run the mains lead in such a way that there is no risk of anyone tripping over it.
- Make sure that the correct type of laminating film is used depending on whether or not you are Hot Laminating or Cold Laminating.
- The laminator is intended for personal use only and should not be used continuously. We recommend that you turn off the machine and let it cool for 30 minutes after 2 hours of use.

KNOW YOUR LAMINATOR

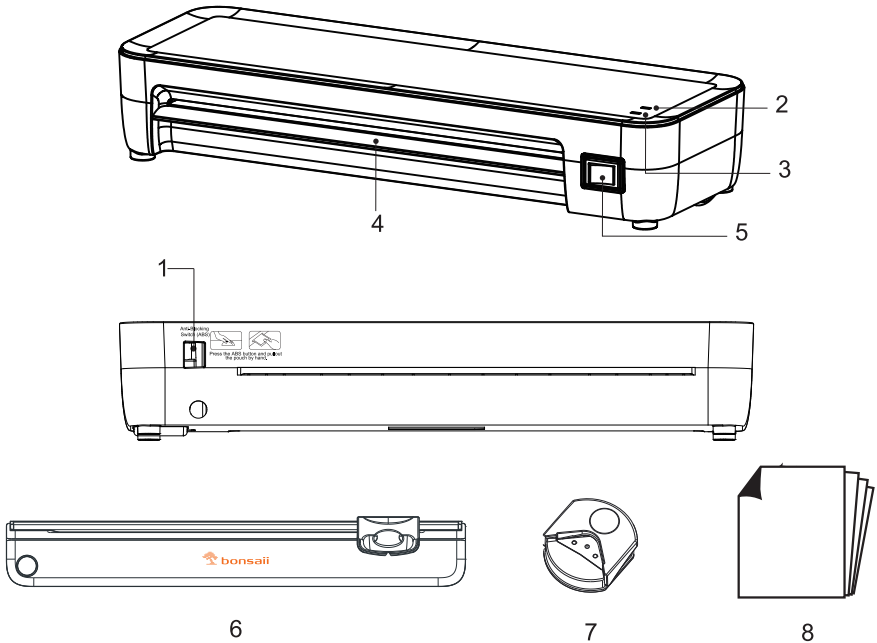

1.ABS Button (Paper release function)

2.Preheating indicator light

3.Power indicator light

4.Laminator inlet

5.Control switch

6.Paper Trimmer

7.Corner Rounder

8.Laminating Film

PRODUCT SPECIFICATIONS

Voltage	120VAC/60Hz, 2.2A		
Laminating Speed	10.63inches/min	Feeding Opening Width	240mm(9.45 Inches)
Preheating Time	<4min	Maximum laminating size	A4
Pouches Thickness	3mil~5mil (photo)	Maximum laminating Thickness	0.02inches
Glue Roller quantities	2PCS	Net Weight	2.16LBS(0.98Kg)
Product Size (L*W*H)	332x112x62mm 13.07x4.41x2.44inches	Function	(Paper release function) ABS bottom

PACKAGE

Item	Quantity
Manual	1PCS
Bonsai Laminator	1PCS
Paper Trimmer	1PCS
Corner Rounder	1PCS
Laminating Film	A4x10PCS / A5x15PCS / A6x15PCS

WARNING

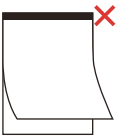

1. Do not laminate an empty pouch.

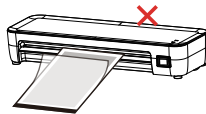

2. Place the sealed end of the pouch into the machine, with the open end following behind.

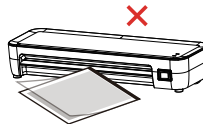

3. Pay attention to the position alignment. Make sure it is inserted in parallel.

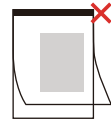

4. Center your item inside the pouch checking that you leave laminate margin on every side for best sealing results.

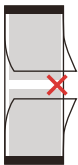

5. Do not connect the laminating pouch to each other.

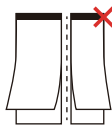

6. Cut/Trim pouches only after feeding through the machine.



7. Do not use deformed laminating pouch.

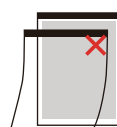

8. Do not laminating two pouches at the same time.

OPERATING INSTRUCTIONS

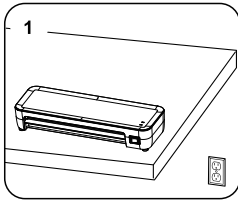

1. Place the laminator on a flat, secure, stable surface.

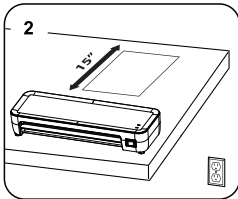

2. Check there is enough clear space (15 inches) behind the machine to allow items to pass through freely.

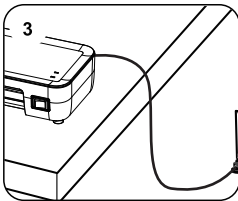

3. Plug the power cord into a standard 120V outlet.

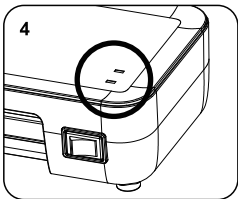

4. Push the control switch to 3 mil or 5 mil position (located on the front of the machine), the red light will come on, the green light is flashing, indicating that the machine enters the preheating state. The Power light will illuminate when the machine is on, and will turn off when the machine is off.

TIPS: The 3 mil setting should be used for laminating standard printer paper or lighter weight items. The 5 mil setting should be used for photo paper, business cards and other thick items.

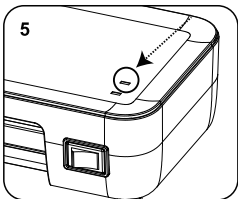

5. Wait for the green Ready light to come on, which indicates the laminator is warm enough for use.

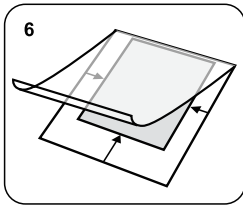

6. Insert the item to be laminated into Bonsai Thermal Laminating Pouch so that your item is close to the sealed (closed) edge of the pouch. Do not cut the pouch if your item is smaller than the size of the pouch or the pouch will likely become jammed inside the laminator.

TIPS: You can trim the pouch after laminating.

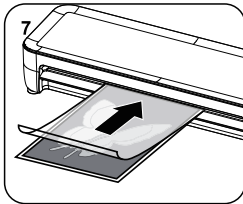

7. Feed the pouch closed/sealed-edge first, straight into the laminator inlet. Hold the pouch until the machine moves it forward.

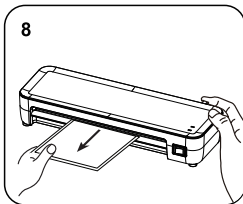

8. The laminated item will automatically exit the outlet of the laminator. Do not pull the pouch through the laminator. If the pouch should become jammed or not feed correctly, push the ABS button (located on the back of the machine) and pull the pouch through the laminator.

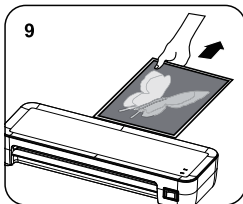

9. Remove the pouch after it has stopped moving and allow the sheet to cool on a flat surface. It may be necessary to laminate thicker items twice to completely seal the pouch.

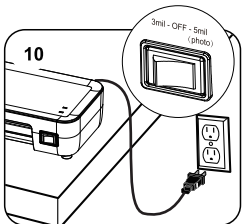

10. When finished laminating, turn off the control switch to OFF the laminator.

Rounded Corner Trimmer



Use to trim and round the sharp corners of laminated documents, cartons, photos, paper etc.



The waste stored in a special compartment.

Paper trimmer

- Trimmer for straight cuts
- Cutting length 12inches
- Simple and safe cutting,without support
- No risk of injury
- Convenient to carry around, doesn't take up much space



TROUBLE SHOOTING

Issue	Reason	Solution
The effect of lamination isn't well or not sticky.	Setting the gear of laminator isn't suitable for the thickness of laminating pouches, It causes the temperature on the low side.	Please kindly refer the indicator label on laminator or user's manual to select related laminating pouches and set the related gear.
There are bubbles or wrinkles after lamination.	Due to the laminating pouch is thin, and the temperature of laminator is too high.	Please kindly turn down the temperature, And then you can use it after the laminator from ready status changes to work status.
The laminator doesn't preheat.	The preheating part of laminator is broken.	<ol style="list-style-type: none"> 1. This one needs professional person to fix it. 2. If your laminator is in limited warranty, Please kindly contact with us customer service to serve for you.
The laminator plugs in, but it cannot be laminated.	The laminator inside gets the trouble in Jam.	<ol style="list-style-type: none"> 1. If this is small case or just a little foreign objects in the laminator, Please kindly turn off the laminator first and unplug the power, and then move the laminator's shell and clean it with professional cleaner of laminator or soft cloths. 2. If there are a lot of foreign objects in laminator inside, Please kindly take the laminator to professional store for maintenance.
	Gear transmission is broken.	<ol style="list-style-type: none"> 1. Please kindly take the laminator to professional store for maintenance. 2. If your laminator is in limited warranty, Please kindly contact with us customer service to serve for you.
	The motor is broken.	<ol style="list-style-type: none"> 1. Please kindly take the laminator to professional store for maintenance. 2. If your laminator is in limited warranty, Please kindly contact with us customer service to serve for you.
Jam issue.	The laminated documents or photos are jammed into laminator.	Please kindly press "ABS jam release button" to pull out the jammed documents and photos.

Issue	Reason	Solution
Loud Noise	Due to the laminator works for a long time based on high temperature, and the lubricant oil of each gear transmission is lossed.	1. Please kindly take the laminator to professional store for periodic maintenance. 2. If the using frequency is often, We advise to take the laminator to do maintenance per month one time.
	This is the voice of reducing the speed for laminator motor.	This is the laminator features, Becase the laminator needs to relieve when it works on slow speed. If you think this one affact you, Please kindly refind a suitable place to use it.

If the above answers cannot solve your problems, please kindly contact with us customer service team via email :**customer-care@bonsaii.com**.

LIMITED WARRANTY

Warranty Period: The machine has a 1-year limited warranty. This underwriting range is counted from the date you originally retail products here. This limited warranty cannot be transferred to any subsequent purchaser or recipient for the product.

We have great confidence in our products and offer a 30-day money-back guarantee. During this period, if the product has manufacturing defects or fails to meet your expectations, please notify us via email within 30 days of receiving the product. We will assist you in returning or replacing the product. Once the complete return is processed, your original payment method will be refunded in full. After 30 days, a restocking fee of 20% may be charged for the return, and all shipping and handling costs will be borne by the customer. After 60 days, the product is non-refundable.

Further details regarding returns are as follows:

If you receive a damaged product, you must notify us within 48 hours of receipt. We will investigate the claim and inform the shipping company of the damage. Please keep all packaging for bonsaii or the shipping company to inspect if necessary. These investigations may take a few days, but the replacement of the goods will be processed as soon as possible.

If the product has defects or damages, we are sorry to hear that it did not meet your expectations perfectly. We aim to resolve this issue as quickly as possible with the help of our customer support team and quality assurance team. They will need to know your order information and the issues you have encountered with the product. Please inform us of your concerns by email and provide the order number. We may require you to take a short video or photos of the product's flaws. After preliminary analysis of the video or images, if it is confirmed that the product has defects, we will immediately send a brand-new replacement product. If we determine that you have misjudged the condition of the product and there are no defects, we will provide you with the correct instructions for use and assist you in using the product correctly.

In line with our policy of continuous development we reserve the right to change this product, packing and documentation specification without notice.

If you have any questions or any confusions, Please kindly contact with us:

customer-care@bonsaii.com.



Manufacture: Bosen Electronics Limited

📍 : No. 11, Lunpinchong Industrial Zone, Houjie Town,
Dongguan City, Guangdong Province, China, postal code 523941.

✉ : customer-care@bonsaii.com

☎ : 1-844-728-6917

Made in China