



bonsaii

DocShred C234-B Paper Shredder Instruction Manual 8 Sheets Cross Cut



Customer Service: customer-care@bonsaii.com
1-844-728-6917







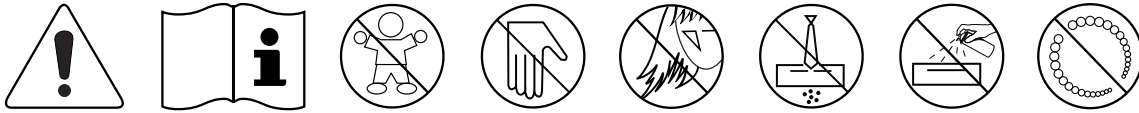

Dear customer,

Thank you for purchasing this quality product. Please carefully read through this manual before first using the device, paying particular attention to the safety warnings. You can find information on how to contact support at the end of these operating instructions.

Safety precautions:



⚠ Cautions:

1. Please read the manual before operating the machine  .
2. Keep all loose articles of clothing, ties , jewellery , hair  or other small items away from the feed opening to prevent injury.
3. Take out the power plug when the shredder is not in use for prolonged periods of time.
4. Do not place hands  or fingers into the shredder throat as serious injury could result.
5. Always turn off or unplug the shredder prior to moving, cleaning or emptying the wastebasket.
6. Empty wastebasket frequently. Otherwise the shredder may jam.
7. The document shredder must always be deactivated and disconnected from the electrical line prior to moving, transporting and cleaning the device and prior to emptying the waste basket.
8. Please do not leave the document shredder unattended e.g. in the event children  or pets are nearby.
9. The device may not be operated with a damaged power cord.
10. For indoor use only.
11. This machine is no toy. Keep it away from children  and pets.
12. To protect the machine well, we suggest the user to operate it in this way: work 4 minutes then rest 40 mins.
13. Clean the drip trays and paper cutter with a slightly dampened cloth and possibly with a mild detergent.
Do not spray directly into the feed slot to avoid damages  .
14. Statement indicating that the socket-outlet shall be installed near the equipment and shall be easily accessible.
15. Hazardous Moving Parts. Keep Fingers and Other Body Parts Away.

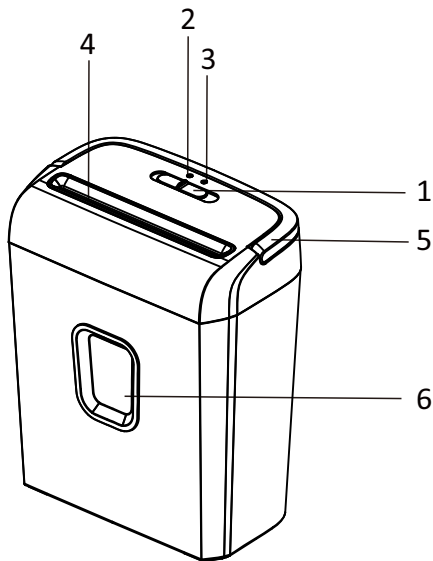

Operation instruction:

1. Slide Switch: FWD/AUTO/OFF/REV
2. Power Light: Green
3. Overheat/Overload: Red/Flashing Red
4. Feed Slot for Paper & Credit Card
5. Handle
6. Transparent Window

Setup:

1. Unpack the shredder. Place the shredder upright on a level surface.
2. Make sure the waste bin is properly inserted into the shredder cabinet.
3. Plug the power cord into a standard(120V)outlet. Do not use an extension cord.

Operating the shredder:

The sliding switch is located on the top side of the unit and can be set to four (4) positions :

1. AUTO:

The shredding operation starts automatically as soon as the paper to be shredded is inserted into the feed slot, the "POWER" indicator light turns green. After the shredding operation is complete, the device will automatically deactivate.

2. REV:

Rectifying a paper jam. In this case, the direction of the shredding operation is reversed before the work cycle ends in order to free the shredding blades. The "POWER" indicator light turns green. Should you determine that too much paper has been inserted and the shredding operation slows noticeably, immediately set the switch to this position, also in the event paper is accidentally inserted.

3. OFF:

In order to empty the waste basket or in the event the device is not used for a prolonged period of time, set the switch to OFF and disconnect the device from the electrical line in order to avoid the risk of injuries. The indicator light switches off.

4. FWD:

The shredder will forward when slide the switch to this position, and the "POWER" indicator light turns green. If the paper jams when the switch is at AUTO position, please slide the switch to FWD to shred the paper through the slot.

Shredder capacity:

C234-B will shred eight(8)sheets of A4 size 75g/m²paper maximumly at a single pass, and will accept paper width up to 220mm. When shredding small material like envelopes or receipts, insert them through the middle of the feed opening.

Protection against paper jams and overheating:

The C234-B is equipped with a motor overheat guard. To protect the machine well, we suggest the user to operate it in this way: work 4 minutes then 40 minutes off. The shredder may stop working automatically in case of following abnormal situations:

1. Continual operation of the shredder with maximum capacity for a prolonged period of time, e.g. longer than 4 minutes without interruption.
2. Overrunning the shredding capacity e.g. adding more than 8 sheets of paper (75g/m²) in one operation or in the event the paper is not inserted length-wise into the feed slot.

Under the above-mentioned conditions, the automatic overheat guard of the motor is triggered, whereupon the current feed to the device is interrupted. In such a case, please take the following steps:

1. Disconnect the main plug from the AC socket in order to avoid the risk of serious injuries and wait at least 40 minutes until the overheat guard has reset. Now tear off excess paper from the top of the shredder or remove it.
2. Reconnect the main plug to the AC socket and set the switch to the REV position. Pull the remaining paper away from the shredding blades. Afterwards, set the switch back to the AUTO position. If necessary, repeat this step.
3. With the switch in the AUTO position and the open feed slot, you may now continue the normal shredding process.

Overloading:

If you overload more than 8 sheet paper in one time, the overheat indicator will flash, and the cutter will stop immediately. In this event, Set the switch to 'REV' and remove the paper. Reduce the number of sheets and then try again.

Attention :

Never shred envelopes(any window, insulated or with glued flaps), adhesive materials (labels, decals /stickers or glued paper), newsprint, transparencies, laminated documents, continuous forms, cardboard, or hard and plastic materials (except credit cards).

Technical specification:

Cutting Capacity:	Max. 8 sheets
Cutting Size:	5/25"×18/25"
Cutting Speed(m/min):	1.8m/min(8 sheet)
Security Level:	P-4
Noise Level:	70 dB
Shred Functions:	paper/credit card/clip/staple
Net Weight:	8.6 pounds
Working Cycle(min):	4 mins
Trash Bin:	3.4 Gallons
Dimension(inches):	11.8×7.1×14.4 inches
Power Supply:	120VAC, 60Hz, 2.0A

Troubleshooting

Error	Troubleshooting	Resolution
Equipment is not functioning	Is the power supply and socket connected to the wall correctly?	Adjust the connections.
	Is the collection unit positioned correctly?	Adjust the position of the collection unit.
	Is the power cable damaged?	Replace the power cable or call product support 1-844-728-6917.
	Is the engine possibly overheating? Is the light turn on?	Wait until the machine has cooled down.
	Is the sheet of paper too thin for it to be detected by the sensors?	Fold the sheets of paper.
	Do you want to shred many pieces of paper at a single pass?	Reduce the amount of paper and try again.
Cutter is blocked	Is the paper jammed?	Push the switch to REV position and remove any excess paper.
Cutter will not stop	Excess paper or unusual objects are blocking the sensors?	Remove any excess paper and try again.
Machine sounds too loud	Is the surface uneven? Is the equipment in a straight position?	Place the equipment on a flat surface.

Should the instructions above not help resolve the issue, then please contact our product support:

Email Service: customer-care@bonsaii.com

Call Service: 1-844-728-6917

WARRANTY

The warranty for this appliance is for 12 months from the date of first purchase from an authorized dealer. The appliance has been manufactured with care and meticulously examined before delivery. Please retain your receipt as proof of purchase. In the case of a warranty claim, please make contact with our Customer Service.

Notice

The warranty covers only claims for material and manufacturing defects, but not for transport damage, wearing parts or for damage to fragile components, e.g. buttons or batteries.

This product is for home and office use only and is not intended for commercial use. The warranty is void in the case of abusive and improper handling, use of force and internal tampering not carried out by our authorized service branch.

Your statutory rights are not restricted in any way by this warranty. The warranty period is not extended by repairs made under the warranty. This applies also to replaced and repaired parts.