

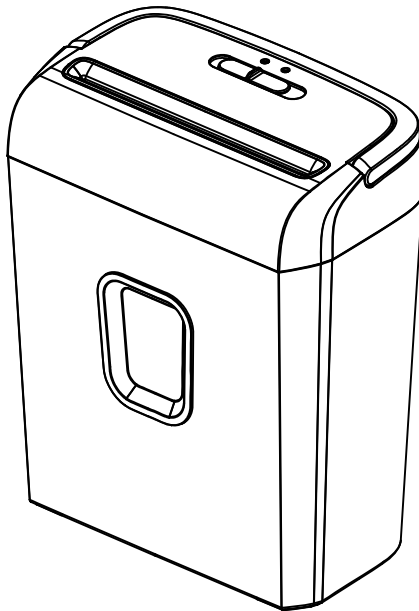

# **bonsaii**

## **Paper Shredder C234-A**

### **Instruction Manual**



---

THIS INSTRUCTION BOOKLET CONTAINS IMPORTANT SAFETY INFORMATION.  
PLEASE READ AND KEEP IT FOR FUTURE REFERENCE.

Please give us a chance to make it right and do better!  
Contact our friendly customer service department for help first.  
Replacements for missing or damaged parts will be shipped.

**Customer Service:**

✉ : [customer-care@bonsaii.com](mailto:customer-care@bonsaii.com)

☎ : 1-844-728-6917

## **TIPS:**

Thank you for choosing our product!

To ensure that the machines are free of quality issues, we conduct 100% inspections.

However, some shred papers may remain in the basket or on the blades during

machine testing. If this causes any discomfort or inconvenience, please contact our

customer service and we will provide better service for you. Thank you!



## **IMPORTANT!**

1. Please read and keep the manual for future reference.
2. Carefully read each step and follow the correct sequence of operation.
3. Please place the equipment on a flat and stable surface to prevent tipping over, as this may cause the machine to crack or become unusable.
4. The device should be placed as close as possible to an accessible wall outlet.
5. Do not disassemble, modify or repair the device on your own to avoid electric shock, injury or damage to the machine.
6. When you empty the basket, move the device, or do not need to use the device for a period of time, make sure the device is turned off and unplug the power plug to prevent fire or electric shock.
7. Do not use flammable liquids, gases, water or cleaners to clean the device to avoid fire or electric shock.
8. Do not use the device in a high temperature, high humidity, or heavily dusty environment to prevent fire, electric shock, or machine malfunction.
9. Do not put tape, carbon copy paper, fabric, plastic film, etc. into the device for shredding to avoid damage to the machine.
10. Do not damage or process the power cord, and do not place heavy objects on the cable to avoid fire, injury or electric shock.
11. If smoke or odor occurs during use, immediately turn off the power and stop using it to prevent fire or electric shock.
12. Do not use the shredder or power cord if it is damaged or defective to avoid fire or electric shock.
13. Do not shred greeting cards with sound chips or batteries to avoid fire or electric shock.
14. Where the mains plug or an appliance coupler is used as the disconnect device, the disconnect device shall remain readily operable.

# IMPORTANT SAFETY INTRODUCTIONS BEFORE FIRST USE



WARNING



User information / safety instructions.



Please do not allow children to use the machine.

\* There are sharp blades inside the machine so as to avoid injury. Please be sure to exercise caution when using it.



Please do not put your hand close to the shredder blades and the paper feed opening.

\* There are sharp blades inside the machine so as to avoid injury. Please be sure to exercise caution when using it.



Please do not let hair near the shredder's feed opening.

\* If your hair is accidentally sucked in, please use the "reverse function" to remove the danger.



Please keep your clothing or some small items away from the feed opening of the paper shredder, such as ties, necklaces, sleeves, jewelry, etc.



Please don't use inflammable liquids, gases water and cleaner to clean the machine.

\* To avoid fire accident.



Please kindly don't touch the sharp edges to avoid injury .



This equipment is not intended for use by children. Avoid touching the media feed opening with the hands, clothing or hair. Unplug this equipment when not in use for an extended period of time, Hazardous moving part is in this equipment, keep body parts away from moving parts.



It cannot be over 6 sheets in one time for the quantity of shredding.

**One folded sheet of paper equates to 2 sheets of paper.**

**Heavier paper, humidity or other than rated voltage may reduce capacity.**

**85% Maximum sheets per pass to avoid jams.**

# KNOW YOUR SHREDDER

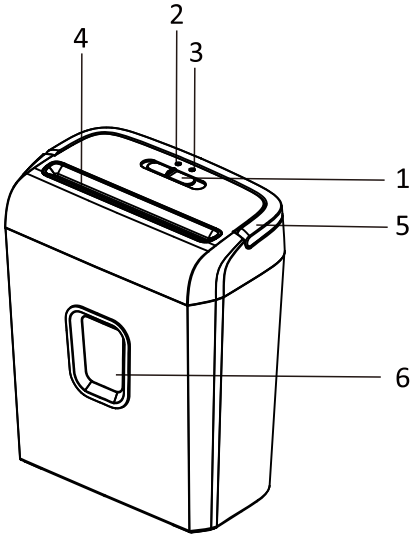

## Operation instruction:

- 1.Slide Switch: FWD/AUTO/OFF/REV
2. Power Light: Green
- 3.Overheat : Red
4. Feed Slot for Paper &Credit Card
- 5.Handle
- 6.Transparent Window

For safety reasons, shredder will operate only if the shredder head is in correct position and used with supplied basket.

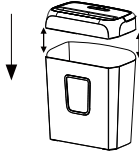

# TECHNICAL SPECIFICATIONS

Voltage	120VAC , 60Hz		
Feeding Opening Capacity	6 sheets/time(A4 20LB) One sheet of credit card/time	Feed Opening (L*W)	220 x 4.0mm 8.66 x 0.16 Inches
Shred Type	Micro Cut	Basket Type	Lift off
Basket Capacity	3.4Gallons/13L	Shred Paper Size	5/32*15/32Inches (4*12mm)
Product Size (L*W*H)	300x180x362mm 11.81x7.09x14.29Inches	Shred Functions	Paper,credit card , staple,clips

**TIPS: ONE FOLDED SHEET OF PAPER EQUATES TO 2 SHEETS OF PAPER**  
**Heavier paper, humidity or other than rated voltage may reduce shredding capacity.**

# OPERATING INSTRUCTIONS

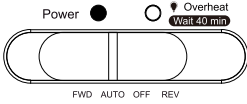

1. Plug in and move “control panel” from OFF to AUTO position, “Power Light” in green. (feed papers , clips , staple or credit card to feed opening ).



**Continuous operation around 4 minutes.**

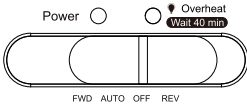
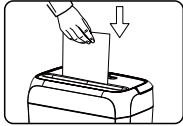

2. When finished shredding or no need to use it, please set to OFF.

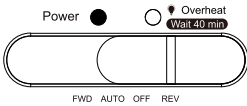

**Jam:** Please move “control panel” from “Auto” to “REV” position and pull out the jammed paper.

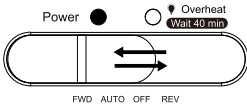

\* Move “control panel” from “REV” to FWD position for 3-5 seconds staying (repeat the operation around 2-3 times if get a very serious jam)

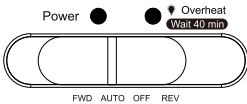

**Overheat** (power light is in green and indicator light in red, need to wait for cooling down). ⌚ **Cool down around 40 minutes**



**Max.6 sheets:** If it is over the capacities ,please take out the excess papers ( 75g/20LB).

# PRODUCT MAINTENANCE

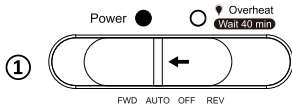

Plug in and move “control panel” from OFF to AUTO position, “Power Light” shows green light. (Feed one shredder Lubricant pack to shred )

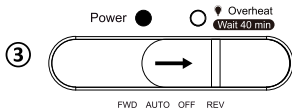

Move “control panel” from Auto to “REV” position for 2-3 seconds staying and don't pull out the shredder lubricant pack.

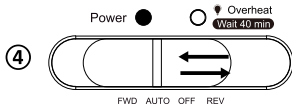
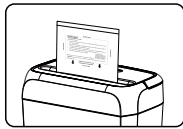

Move “control panel” from REV to AUTO position to shred the shredder lubricant pack for 3-5 seconds staying and repeat the operation for 2-3 times till the shredder lubricant pack is fully shredded.

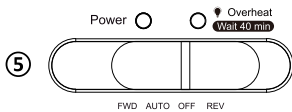

When finished shredding or no need to use it , please set to OFF.

## CAUTION

\* Only use the professional shredder Lubricant pack to maintain the shredder such as Bonsai shredder Lubricant 24-Pack ( LS24 )/12-Pack ( LS12).(no cleaner ,inflammable liquids ,gases oil etc...  )

# TROUBLESHOOTING

Malfunction	Reason	Solution
The shredder does not work	The power plug doesn't connect to the power supply.	Make sure the unit is plugged in and that the outlet is in good working order.
	The shredder switch is not set to the "AUTO/ON" position.	Make sure the plug is inserted into the correct power outlet, and flip the switch to the "AUTO/ON" position, the power indicator lights up.
	Overheating with extended use.	In the event that the shredder has shred continuously beyond the maximum running time and overheated, the unit will automatically shut off. If this happens, switch the shredder off for 40 minutes or longer before resuming normal operation.
	Safety interlock switch not to operate properly. 	Make sure the shredder head is correctly seated onto the included wastebasket, with all the words and icons facing towards you. The head unit is particularly designed to work only with the integrated wastebasket. The shredder is equipped with a safety interlocking mechanism, which prevents the shredder from working when the head unit is lifted, removed, or accidentally knocked over. The shredder will not function until the head unit is properly assembled as pictured.
	Using plastic bag to line the wastebasket.	Please remove it. This may cause the shredder not to operate properly.
	The basket is full.	Empty the basket.
	The activation sensor of the shredder is located near the center of the feed slot.	Be sure to feed directly into the center area to activate the machine (especially applies to smaller pieces of paper or credit cards)
	Damage of power cable.	Please replace the power cable with the same parameters by professional person or contact with our customer service.
	Defective of machine.	Please kindly contact with our customer service.
Won't shred MAX sheets	Paper jam.	NEVER SHRED THE FOLLOWING ITEMS: Large paper clips (remove small clips whenever possible) Envelopes (especially windowed or glued flaps) Adhesive materials such as labels, stickers, or glued paper Newsprint, tissue, or any similar thin paper stock Transparencies, film, or laminated documents Continuous forms or paper rolls Cardboard / Corrugated board or fabric Plastic or hard items (except Credit Cards & CDs if applicable)



Malfunction	Reason	Solution
Won't shred MAX sheets	Paper jam.	<p>1) Lift up the shredder and check whether the outlet is blocked by paper. If there is a lot of paper attached to the outlet, please disconnect the power supply, manually remove the paper at the outlet, and then place the shredder on the basket correctly. Move "control panel" from "REV" to FWD position for 3-5 seconds staying (repeat the operation around 2-3 times if get a very serious jam)</p> <p>2) Switch the shredder to Reverse (REV) mode. While in Reverse, the shredder will back up and loosen the jammed paper. If required, you may need to tug and remove several sheets to effectively clear the machine. When jammed paper is loosened or removed, switch back to the Auto-On mode to continue shredding. Repeat steps if needed.</p> <p>3) With stubborn situations where the reverse function does not help, you may need to clean the jammed paper with shredder oil (cooking oil is acceptable, but don't use aerosol). Start by drizzling oil into the feed slot where the paper is jammed. Let it soak for about 30 minutes to completely saturate. Turn the shredder to Auto-On (or FWD) mode. If required, an index card or a rigid sheet of cardstock (old greeting card or folded file folder) can be fed into the shredder to help push the jammed paper through.</p> <p>4) With the shredder unplugged, you may use a set needle-nose pliers or tweezers to remove the blockage.</p>
The shredder is constantly running while in "Auto (On)" mode.	Paper dust and other foreign objects cover the mechanical sensor. The location of mechanical sensor is in the middle of shredder's feeding opening look like a small plastic divider.	It is possible that the activation sensor, which starts the shredder, is blocked with paper. Insert an index card or any rigid sheet of cardstock (old greeting card or folded file folder), directly in the center of the feed slot, while applying force to help push the jammed paper through. This will usually clear any paper blocking the activation sensor and feed slot.
The shredder runs in "Rev (Reverse)" mode but not in "Auto (On)" mode.	It is also possible that the feed slot has become blocked with paper.	Insert an index card or any rigid sheet of cardstock (old greeting card or folded file folder), directly in the center of the feed slot, while applying force to push the jammed paper through. This will usually clear any paper blockage.

# LIMITED WARRANTY

Warranty Period: Machines are covered by a 1-year limited warranty and cutters are warranted for 1 years from the date of your original retail purchase from us. The warranty is not transferable to any subsequent purchaser or recipient of the product.

We have great confidence in our products and offer a 30-day money-back guarantee. During this period, if the product has manufacturing defects or fails to meet your expectations, please notify us via email within 30 days of receiving the product. We will assist you in returning or replacing the product. Once the complete return is processed, your original payment method will be refunded in full. After 30 days, a restocking fee of 20% may be charged for the return, and all shipping and handling costs will be borne by the customer. After 60 days, the product is non-refundable.

Further details regarding returns are as follows:

If you receive a damaged product, you must notify us within 48 hours of receipt. We will investigate the claim and inform the shipping company of the damage. Please keep all packaging for bonsaii or the shipping company to inspect if necessary. These investigations may take a few days, but the replacement of the goods will be processed as soon as possible.

If the product has defects or damages, we are sorry to hear that it did not meet your expectations perfectly. We aim to resolve this issue as quickly as possible with the help of our customer support team and quality assurance team. They will need to know your order information and the issues you have encountered with the product. Please inform us of your concerns by email and provide the order number. We may require you to take a short video or photos of the product's flaws. After preliminary analysis of the video or images, if it is confirmed that the product has defects, we will immediately send a brand-new replacement product. If we determine that you have misjudged the condition of the product and there are no defects, we will provide you with the correct instructions for use and assist you in using the product correctly.

In line with our policy of continuous development we reserve the right to change this product, packing and documentation specification without notice.

If you have any questions or any confusions, Please kindly contact with us:

**customer-care@bonsaii.com.**





**Manufacture: Bosen Electronics Limited**

📍 : No. 11, Lunpinyong Industrial Zone, Houjie Town,  
Dongguan City, Guangdong Province,  
China, postal code 523941.

☎ : 1-844-728-6917

✉ : [customer-care@bonsaii.com](mailto:customer-care@bonsaii.com)

**Made in Vietnam**