



# **bonsaii**

## **Paper Shredder C149-D**

### **Instruction Manual**

### **16-Sheet Micro-Cut Shredder**



---

**THIS INSTRUCTION BOOKLET CONTAINS IMPORTANT SAFETY INFORMATION.  
PLEASE READ AND KEEP IT FOR FUTURE REFERENCE.**

---

Please give us a chance to make it right and do better!  
Contact our friendly customer service department for help first.  
Replacements for missing or damaged parts will be shipped.

**Customer Service:**

✉ : [customer-care@bonsaii.com](mailto:customer-care@bonsaii.com)

☎ : 1-844-728-6917

# TIPS

---

## **Thank you for choosing our product!**

To ensure that the machines are free of quality issues, we conduct 100% inspections. However, some shred papers may remain in the basket or on the blades during machine testing. If this causes any discomfort or inconvenience, please contact our customer service and we will provide better service for you. Thank you!



## IMPORTANT!

1. Please read and keep the manual for future reference.
2. Carefully read each step and follow the correct sequence of operation.
3. Please place the equipment on a flat and stable surface to prevent tipping over, as this may cause the machine to crack or become unusable.
4. The device should be placed as close as possible to an accessible wall outlet.
5. Do not disassemble, modify or repair the device on your own to avoid electric shock, injury or damage to the machine.
6. When you empty the basket, move the device, or do not need to use the device for a period of time, make sure the device is turned off and unplug the power plug to prevent fire or electric shock.
7. Do not use flammable liquids, gases, water or cleaners to clean the device to avoid fire or electric shock.
8. Do not use the device in a high temperature, high humidity, or heavily dusty environment to prevent fire, electric shock, or machine malfunction.
9. Do not put tape, carbon copy paper, fabric, plastic film, etc. into the device for shredding to avoid damage to the machine.
10. Do not damage or process the power cord, and do not place heavy objects on the cable to avoid fire, injury or electric shock.
11. If smoke or odor occurs during use, immediately turn off the power and stop using it to prevent fire or electric shock.
12. Do not use the shredder or power cord if it is damaged or defective to avoid fire or electric shock.
13. Do not shred greeting cards with sound chips or batteries to avoid fire or electric shock.
14. Do not hold CD/DVD with finger through the center ring while feeding into the shredder. Serious injury may occur.

# IMPORTANT SAFETY INTRODUCTIONS BEFORE FIRST USE



User information / safety instructions.



WARNING



Please do not allow children to use the machine.

\* There are sharp blades inside the machine so as to avoid injury. Please be sure to exercise caution when using it.



Please do not put your hand close to the shredder blades and the paper feed opening.

\* There are sharp blades inside the machine so as to avoid injury. Please be sure to exercise caution when using it.



Please do not let hair near the shredder's feed opening.

\* If your hair is accidentally sucked in, please use the "reverse function" to remove the danger.



Please keep your clothing or some small items away from the feed opening of the paper shredder, such as ties, necklaces, sleeves, jewelry, etc.



Please don't use inflammable liquids, gases water and cleaner to clean the machine.



\* To avoid fire accident.



Please kindly don't touch the sharp edges to avoid injury .



This equipment is not intended for use by children. Avoid touching the media feed opening with the hands, clothing or hair. Unplug this equipment when not in use for an extended period of time, Hazardous moving part is in this equipment, keep body parts away from moving parts.



It cannot be over 16 sheets in one time for the quantity of shredding.

**One folded sheet of paper equates to 2 sheets of paper.**

**Heavier paper, humidity or other than rated voltage may reduce capacity.**

**85% Maximum sheets per pass to avoid jams.**

# KNOW YOUR SHREDDER

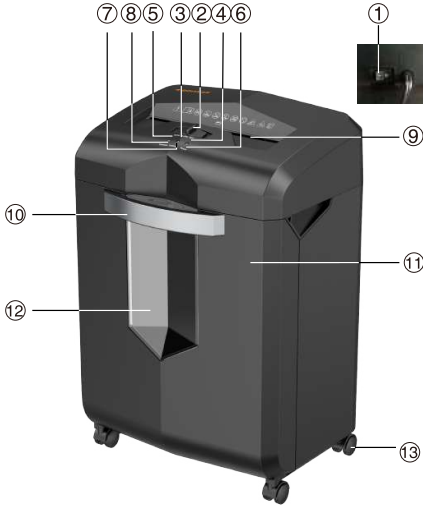

- ① Power switch(ON/OFF)
- ② Control panel (Control shredder's three status "REV" "AUTO" "STOP")
- ③ Stop position ( stop working status)
- ④ Reverse Position ("Release the paper")
- ⑤ Auto position (under work status)
- ⑥ Power light (work status in red)
- ⑦ Overload indicator light (overloading in red with flashing)
- ⑧ Overheat indicator light(Overheating in red)
- ⑨ Feeding opening
- ⑩ Basket handle
- ⑪ Basket
- ⑫ Transparent Window
- ⑬ Shredder's caster

For safety reasons, shredder will operate only if the shredder head is in correct position and used with supplied basket.

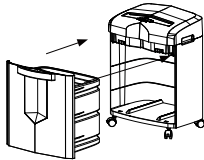

## TECHNICAL SPECIFICATIONS

Voltage	120VAC, 60Hz		
Feeding Opening Capacity	16 sheets/time(A4 20LBS) one sheet of credit card/time one sheet of CD/time	Feed Opening (W*L)	5.5 x 222 mm 0.22 x 8.74 Inches
Shred Type	Micro-Cut	Shred Paper Size	5 x 12mm (13/64x15/32 inches)
Basket Capacity	6.08Gallon/23L	Basket type	Pull out
Product Size (L*W*H)	360 x 285 x 545 mm (14.17x11.22x21.46 inches)	Shred Functions	Paper, plastic credit card, staple, clips, CD

**TIPS: ONE FOLDED SHEET OF PAPER EQUATES TO 2 SHEETS OF PAPER**  
Heavier paper, humidity or other than rated voltage may reduce shredding capacity.

# OPERATING INSTRUCTIONS



1. Plug in and press the power switch “ - ”.

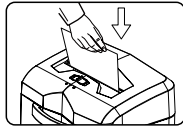
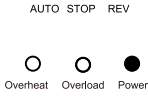
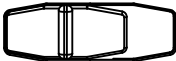

2. Moving “control panel” from “Stop” to “Auto” position, Power light in red. (Feed papers, credit card, CD, clips or staple to shred.)

Continuous operation around 60 minutes.

**WARNING**



Beware of injury caused by CD splashing or incorrect CD shredding. Please wear safety goggles and shred the CD in a correct way.

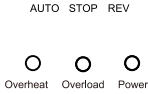
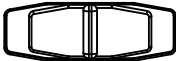

3. When finished shredding, set to Stop position and turn off the power switch “O”.

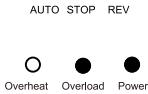
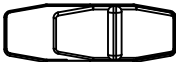

**Jam:** Please move “control panel” to “REV” position and pull out the jammed paper

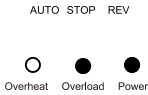
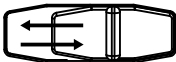
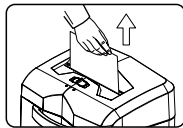

\* Moving “control panel” from “Auto” to “REV” position for 3-5 seconds staying. (If it meets a very serious jam, Please kindly repeat this operation around 2-3 times )

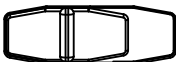

**Overheat** (overheat in red, Power light in red, need to wait for cooling down.) Cool down around 10 minutes

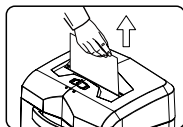
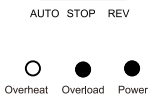
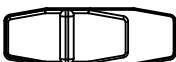

**Overload** (Overloading in red with flashing, power light in red, need to take out excess papers.)

# PRODUCT MAINTENANCE

①  Plug in and press the power switch “-”.

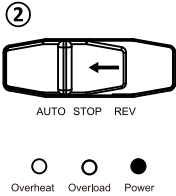

③  Moving “control panel” from “Stop” to “Auto” position, power light in red .( Feed one shredder lubricant pack to shred)

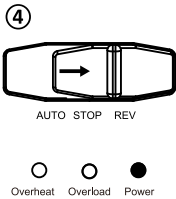

④  Move “control panel” from Auto to “Reverse” for 2-3 seconds staying (don’t pull out the shredder lubricant pack)

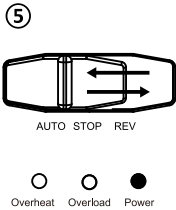

⑤ Move “control panel” from REV to AUTO to shred the shredder lubricant pack for 3-5 seconds staying and repeat the actions for 2-3 times till the shredder lubricant pack is fully shredded.

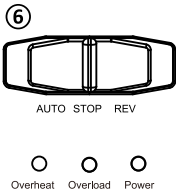

⑥  When finished shredding, set to Blank position and turn off the power switch “O”.

**CAUTION**

\* Only use the professional shredder Lubricant pack to maintain the shredder such as Bonsaii shredder Lubricant 24-Pack ( LS24 )/12-Pack ( LS12).(no cleaner ,inflammable liquids ,gases oil etc... )

# TROUBLESHOOTING

Malfunction	Reason	Solution
Stop Working	The power plug doesn't connect to the power supply.	Please kindly check whether you use the machine with related supply voltage or Plug in again correctly.
	Power supply voltage is too low or no power supply.	Please kindly find a related supply voltage to use it .
	The machine is under overheating protection, because the machine is over the continues working capacity.	Wait for the machine to cool down naturally.
	The thickness of paper is too thin.	To make the paper thicker ,You can add more papers or fold the paper.
	The machine is overloading, because the paper is over machine Max shredding quantities.	Reduce paper quantity with an acceptable amount and place the paper into the feeding opening of shredder again.
	Damage of power cable.	Please replace the power cable with the same parameters by professional person or contact with our customer service.
	The basket is full.	Empty the basket.
	Defective of machine.	Please kindly contact with our customer service.
Jam	Paper jam.	Please kindly use the function of "Reverse" to take out the excess paper.
Keep Running	Paper dust and other foreign objects cover the sensor. The location of sensor is in the shredder's feeding opening look like glass beads or marbles.	1.Please unplug first and use soft cloth or cotton swab to clean the foreign objects without any cleaner or water . 2.If there are some paper scraps around the sensor area ,please kindly use cotton swab or needle nosed pliers to take out the paper scraps . <b>⚠CAUTION</b> :please don't overexert and use Sharp tools to clean or poke the sensor to avoid damaging the sensor.
Loud Noise	The shredder is placed on an unsuitable place.	Change the location.

If the above answers can not solve your problems, please kindly contact with our customer service team via email [customer-care@bonsaii.com](mailto:customer-care@bonsaii.com)



# LIMITED WARRANTY

Warranty Period: Machines are covered by a 1-year limited warranty and cutters are warranted for 1 years from the date of your original retail purchase from us. The warranty is not transferable to any subsequent purchaser or recipient of the product.

We stand by our product and offer a 30-day money-back guarantee. During this time, you could return the item without paying any extra fee if there is a manufacturing defect in it. Please rest assured that the returns are free and easy if there is a manufacturing defect. Otherwise, it would be the customer's responsibility to cover the shipping fee. Products on sale are also returnable.

If the product isn't meeting your expectations, please email within 30-days of receipt. We will help you to either return or exchange your product. Your original form of payment will be refunded in full once the full return is complete. After 30-days orders may be subject to a 20% restocking fee and all shipping and handling charges will be the responsibility of the customer. Additional return details are listed below. After 60-days the purchase from Bonsaii is non-refundable.

If you receive a damaged product, you must notify Bonsaii within 48 hours of delivery. Bonsaii will investigate the claim and notify the freight company about the damage. Please retain all packaging in the event that Bonsaii or the freight company needs to inspect it. These investigations may take several days but merchandise replacements will be processed as soon as possible.

For product arrived defective or damage, We're sorry to hear that your Bonsaii product arrived in less than perfect condition. We'd like to resolve this issue right away with the help of our Customer Support Team and Quality Assurance team. They'll need to know a bit of information on your order as well as the issue you're experiencing with your Bonsaii product. To report your issue, please reach out to our Customer Support team by emailing [customer-care@bonsaii.com](mailto:customer-care@bonsaii.com) with your order number. We may need you to make a short video, or take some pictures of the defects of the product and send them to [customer-care@bonsaii.com](mailto:customer-care@bonsaii.com). After a preliminary analysis on the video or pictures, we will send you a brand new replacement right away if it is confirm to be defective on its arrival. If we determine that you have misrepresented Bonsaii product's condition and that product is not defective, we will send you the right instructions and help you to use the product correctly.

In line with our policy of continuous development we reserve the right to change this product, packing and documentation specification without notice.

If you have any questions or any confusions, Please kindly contact with us:  
**[customer-care@bonsaii.com](mailto:customer-care@bonsaii.com)**.







**Manufacture: Bonsen Electronics Limited**

📍 : No.11-12, Lun Pin Chong Industrial Zone San Tun  
Community, Hou Jie Town 523941 Dongguan City,  
Guangdong PEOPLE'S REPUBLIC OF CHINA

✉ : [customer-care@bonsaii.com](mailto:customer-care@bonsaii.com)

☎ : 1-844-728-6917

Made in China