



bonsaii

Paper Shredder C149-C

Instruction Manual

18-Sheet Cross-Cut Shredder



**THIS INSTRUCTION BOOKLET CONTAINS IMPORTANT SAFETY INFORMATION.
PLEASE READ AND KEEP IT FOR FUTURE REFERENCE.**

Please give us a chance to make it right and do better!
Contact our friendly customer service department for help first.
Replacements for missing or damaged parts will be shipped.

Customer Service:

✉ : customer-care@bonsaii.com

☎ : 1-844-728-6917



IMPORTANT!

1. Please read all instructions carefully and retain instructions for future reference.
2. Read through each step carefully and follow the proper order.
3. Please place this machine on a flat and stable surface place, please be careful and don't tip the machine over .
 - * In case the machine is broken and cannot be used as normal.
4. The device should be set up as close as possible to an easily accessible wall socket.
5. Dangerous, please do not disassemble, modify or repair the machine in any way on your own.
 - * To avoid electric shock, hurting or accidental injury.
6. When you empty the basket, or move the machine, or no need to use the machine for a certain period of time ,Please kindly make the machine under OFF status and unplug.
 - * To avoid fire accident or electric shock.
7. Please don't use inflammable liquids, gases, water and cleaner to clean the machine.
 - * To avoid fire accident or electric shock.
8. Please don't use the machine in a very high temperature, very humidity and very heavy dust environment .
 - *To avoid fire accident, electric shock or machine malfunction
9. Please do not put adhesive tape, carbon paper, fabric, plastic film, etc. into the machine for shredding.
 - * To avoid damaging the machine
10. Please do not damage or process the power cables, or do not place heavy objects on the cables.
 - * To avoid fire accident or, hurting or electric shock
11. If abnormal conditions such as smoke or odor occurred, please disconnect the power and stop using it immediately.
 - * To avoid fire accident or electric shock
12. Please do not use if the shredder or the power cable is damaged or defective
 - * To avoid fire accident or electric shock

IMPORTANT SAFETY INTRODUCTIONS BEFORE FIRST USE



User information / safety instructions.



WARNING



Please kindly let children and pets keep away from the machine.

* There are sharp blades inside the machine so as to avoid injury.



Please kindly let your hands keep away from the sharp blades and feeding opening of paper shredder.

* There are sharp blades inside the machine so as to avoid injury.



Please kindly let your hair keeps away from the feeding opening of paper shredder.

* If your hair is accidentally sucked in, Please kindly use the "Reverse function" and get rid of the danger.



Please kindly let your clothing or some small items keep away from the feeding opening of paper shredder like tie, necklace, sleeves, jewelry, etc..



Please don't use inflammable liquids, gases water and cleaner to clean the machine.

* To avoid fire accident.



Please kindly don't touch the sharp edges to avoid injury .



This equipment is not intended for use by children. Avoid touching the media feed opening with the hands, clothing or hair. Unplug this equipment when not in use for an extended period of time, Hazardous moving part is in this equipment, keep body parts away from moving parts.



It cannot be over 18 sheets in one time for the quantity of shredding.

KNOW YOUR SHREDDER

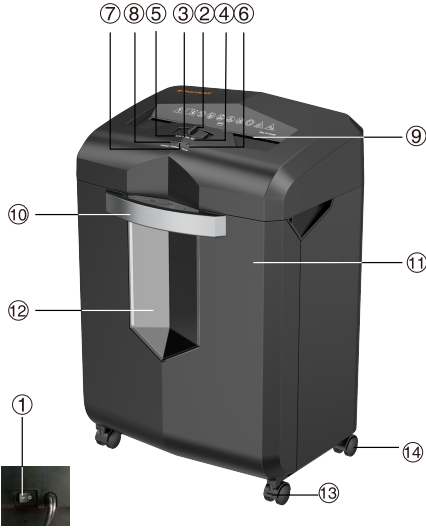

- ① Power switch(ON/OFF)
- ② Control panel (Control shredder's three status "REV" "AUTO" "BLANK")
- ③ Blank position (stop working status)
- ④ Reverse Position ("Release the paper")
- ⑤ Auto position (under work status)
- ⑥ Power light (work status in red)
- ⑦ Overload indicator light (overloading in red with flashing)
- ⑧ Overheat indicator light(Overheating in red)
- ⑨ Feed opening
- ⑩ Basket handle
- ⑪ Basket
- ⑫ Transparent Window
- ⑬ Caster brake
- ⑭ Shredder's caster

For safety reasons, shredder will operate only if the shredder head is in correct position and used with supplied basket.

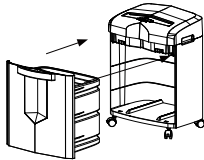

TECHNICAL SPECIFICATIONS

Voltage	120VAC, 60Hz, 3.0A		
Feeding Opening Capacity (A4 80g/m ²)	18 sheets/time	Feed Opening (W*L)	5.5 x 222 mm 0.22 x 8.74 Inches
Shredding Speed	1.6m/min (APX. 11 seconds/per paper)	Shred Type	Cross cut
Basket Capacity	6.08Gallon/23L	Shred Paper Size	5 x 40mm(0.2 x 1.6 Inches)
Product Size (L*W*H)	360 x 285 x 545 mm 14.17x11.22x21.46 inches)	Basket type	Pull out

OPERATING INSTRUCTIONS



1. Plug in and press the power switch “ - ”.

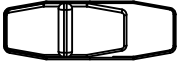

AUTO BLANK REV

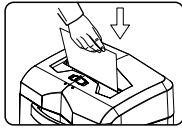

2. Moving “control panel” from “blank” to “Auto” position, Power light in red. (Feed papers, credit card, clips or staple to shred.)

Continuous operation around 30 minutes.

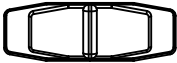

AUTO BLANK REV



3. When finished shredding, set to Blank position and turn off the power switch "O".

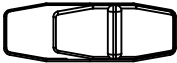

AUTO BLANK REV



Jam: Please move “control panel” to “REV” position and pull out the jammed paper

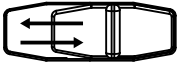
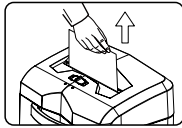

AUTO BLANK REV



* Moving “control panel” from “Auto” to “REV” position for 3-5 seconds staying. (If it meets a very serious jam, Please kindly repeat this operation around 2-3 times)

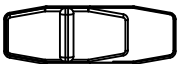

AUTO BLANK REV



Overheat (overheat in red, Power light in red, need to wait for cooling down.) Cool down around 20 minutes

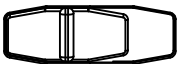

AUTO BLANK REV

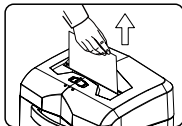

Overload (Overloading in red with flashing, power light in red, need to take out excess papers.)

PRODUCT MAINTENANCE

①  Plug in and press the power switch “-”.

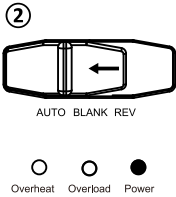

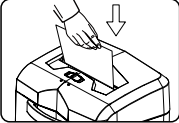
③  Moving “control panel” from “blank” to “Auto ” position, power light in red .(Feed one shredder lubricant pack to shred)

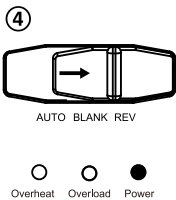

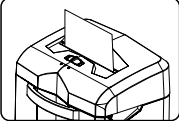
④  Move “control panel” from Auto to “Reverse” for 2-3 seconds staying (don’t pull out the shredder lubricant pack)

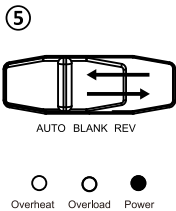

⑤ Move “control panel” from REV to AUTO to shred the shredder lubricant pack for 3-5 seconds staying and repeat the actions for 2-3 times till the shredder lubricant pack is fully shredded.

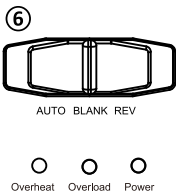

⑥  When finished shredding, set to Blank position and turn off the power switch “O”.



* Only use the professional shredder Lubricant to maintain the shredder such as Bonsaii shredder Lubricant 24-Pack/12-Pack .(no cleaner ,inflammable liquids ,gases oil etc... )

TROUBLESHOOTING

Malfunction	Reason	Solution
Stop Working	The power plug doesn't connect to the power supply.	Please kindly check whether you use the machine with related supply voltage or Plug in again correctly.
	Power supply voltage is too low or no power supply.	Please kindly find a related supply voltage to use it .
	The machine is under overheating protection, because the machine is over the continues working capacity.	Wait for the machine to cool down naturally.
	The thickness of paper is too thin.	To make the paper thicker ,You can add more papers or fold the paper.
	The machine is overloading, because the paper is over machine Max shredding quantities.	Reduce paper quantity with an acceptable amount and place the paper into the feeding opening of shredder again.
	Damage of power cable.	Please replace the power cable with the same parameters by professional person or contact with our customer service.
	The basket is full.	Empty the basket.
	Defective of machine.	Please kindly contact with our customer service.
Jam	Paper jam.	Please kindly use the function of "Reverse" to take out the excess paper.
Keep Running	Paper dust and other foreign objects cover the sensor.	Please unplug first and use soft cloth to clean the foreign objects without any cleaner or water.
Loud Noise	The shredder is placed on an unsuitable place.	Change the location.

If the above answers can not solve your problems, please kindly contact with our customer service team via email **customer-care@bonsai.com**

LIMITED WARRANTY

We stand by our product and offer a 30-day money-back guarantee. During this time, you could return the item without paying any extra fee if there is a manufacturing defect in it. Please rest assured that the returns are free and easy if there is a manufacturing defect. Otherwise, it would be the customer's responsibility to cover the shipping fee. Products on sale are also returnable.

If the product isn't meeting your expectations, please email within 30-days of receipt. We will help you to either return or exchange your product. Your original form of payment will be refunded in full once the full return is complete. After 30-days orders may be subject to a 20% restocking fee and all shipping and handling charges will be the responsibility of the customer. Additional return details are listed below. After 60-days the purchase from Bonsaii is non-refundable.

If you receive a damaged product, you must notify Bonsaii within 48 hours of delivery. Bonsaii will investigate the claim and notify the freight company about the damage. Please retain all packaging in the event that Bonsaii or the freight company needs to inspect it. These investigations may take several days but merchandise replacements will be processed as soon as possible.

For product arrived defective or damage, We're sorry to hear that your Bonsaii product arrived in less than perfect condition. We'd like to resolve this issue right away with the help of our Customer Support Team and Quality Assurance team. They'll need to know a bit of information on your order as well as the issue you're experiencing with your Bonsaii product. To report your issue, please reach out to our Customer Support team by emailing customer-care@bonsaii.com with your order number. We may need you to make a short video, or take some pictures of the defects of the product and send them to customer-care@bonsaii.com. After a preliminary analysis on the video or pictures, we will send you a brand new replacement right away if it is confirm to be defective on its arrival. If we determine that you have misrepresented Bonsaii product's condition and that product is not defective, we will send you the right instructions and help you to use the product correctly.

If you have any questions or any confusions, Please kindly contact with us:
customer-care@bonsaii.com.



Bonsen Electronics Inc.

📍 : 4198 Industry Way, Flowery
Branch, GA, 30542, USA

✉ : customer-care@bonsaii.com

Made In Vietnam