

# mifold®

the Grab-and-Go Child Restraint™

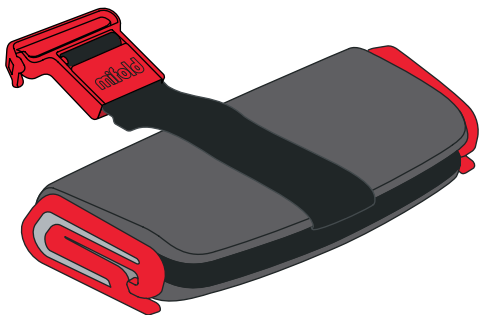

Age 4 years and upwards

Group 2/3 (15-36kg)

Approved to ECE R44.04



P/N - 1189 Rev. B



**Congratulations on buying your mifold Grab-and-Go Child Restraint.** mifold is the most advanced, compact, and portable child restraint ever invented. mifold is more than 10x smaller than a regular backless child restraint, and is just as safe\*.

We hope that you are delighted and satisfied with mifold. We always enjoy hearing from customers with your ideas, thoughts, feedback, pictures and videos.

**You can contact us in many ways:**

✉ [support@mifold.com](mailto:support@mifold.com)

🌐 [www.mifold.com/contact](http://www.mifold.com/contact)

📌 [pinterest.com/mifold](https://www.pinterest.com/mifold)

📘 [facebook.com/mifold](https://www.facebook.com/mifold)

📷 [instagram.com/mifold](https://www.instagram.com/mifold)

\*Safety claim based on compliance with UNECE Regulation 44/04.

## User Manual Storage

It is most important that these instructions remain with the mifold Grab-and-Go child restraint at all times. Store these instructions in the slot located on the edge of the mifold Grab-and-Go child restraint.

Read and follow all instructions and information in this manual, on the product labels, and in the vehicle owner's manual for child restraint and vehicle seat belt use.

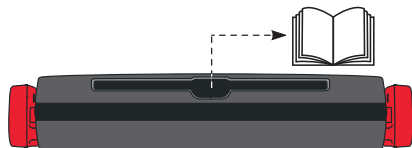

## Introduction to your mifold Grab-and-Go Child Restraint

Before using this child restraint it is important to understand how to properly install your child restraint, secure your child correctly, and familiarise yourself with the features and functions of the child restraint.

It is important to take the time to read and understand these instructions fully. This is best done with the mifold Grab-and-Go child restraint in front of you.

Read all the safety warnings before using the child restraint.

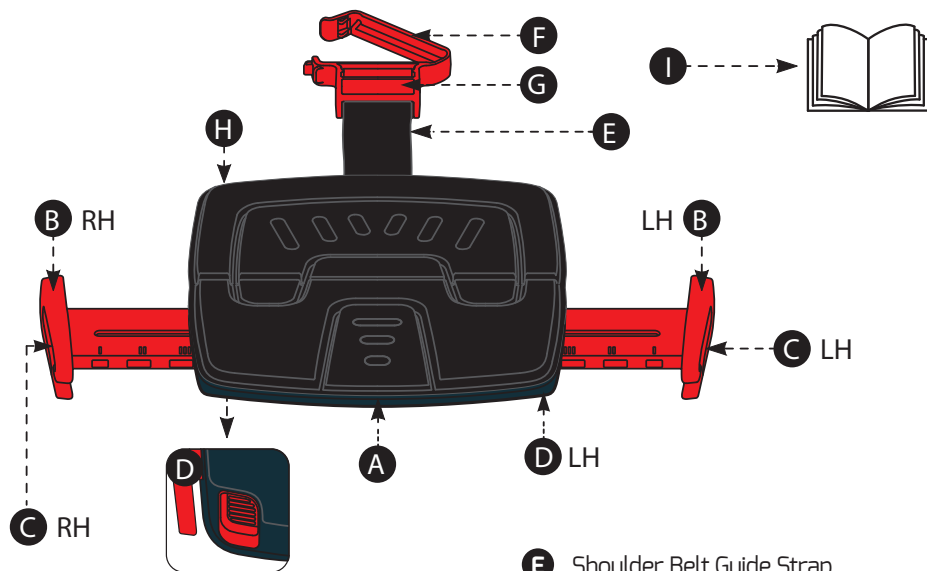

**A** Child Restraint

**B** Lap Belt Guide (RH & LH)

**C** Lap Belt Slot (RH & LH)

**D** Lap Belt Guide Release Button (RH & LH)

**E** Shoulder Belt Guide Strap

**F** Shoulder Belt Guide

**G** Shoulder Belt Guide Buckle

**H** Child Restraint Cushion

**I** User Manual



## Safety Instructions



- Always give preference to using the rear seats of your vehicle even if your highway code permits the use on the front seat.
- Check your highway code as this regulation may vary according to the country.
- Check the vehicle manual for advice on fitting your car seat in the front of the vehicle.
- Airbags can cause injury. Do not use this seat on passenger seats fitted with a frontal airbag.
- Your mifold Grab-and-Go child restraint must be positioned and installed so that, under normal vehicle usage conditions, no part can become jammed under or between any moveable seat, or in the vehicle door.
- Make sure there is no loose luggage or other large objects that are likely to cause injuries in the event of an accident. These items may cause injury to other occupants. Always secure loose items.
- Shade your child restraint from sunlight to avoid hot items causing injury to your child.
- Do not modify or add to your car seat in any way without the approval of a competent authority or the manufacturer, as this will void any warranty.
- Toxic cleaning fluids can cause illness. Never use bleach, do not iron, do not machine wash and do not tumble dry as this could damage the product.



## Safety Instructions



- Do not leave your child unattended while in the child restraint and in the vehicle.
- The mifold child restraint is a unique design that absorbs some of the forces in a vehicle crash when occupied by a child. These crash forces can deform parts of the child restraint and result in damage that may not be detectable by a visual inspection. As a result, the child restraint **MUST** be replaced after any crash in which the child restraint was occupied.
- For a crash in which the child restraint was stored and remained in place or was secured with the lap portion of the vehicle seat belt passing through both lap belt guides, and was unoccupied at the time of the crash, the mifold may continue to be used. Store your child restraint in a safe area when your child is not in the car seat. An unsecured child restraint can cause injuries in the event of a collision.
- If you are in any doubt about any part of the installation or proper use of your child restraint, contact the child restraint manufacturer.
- Failure to follow these instructions may affect your child's safety.
- Keep these instructions with the child restraint to refer to for future reference.

## Install your child restraint

The seat can be used for a child aged 4 years and above, weighing 15kg – 36kg, securing the child with the adult 3 point seat belt approved to ECE R16.

**Note:** Your child restraint is designed to fit only with a 3 point lap and diagonal seat belt and must not at any time be fitted using only a 2 point lap belt.

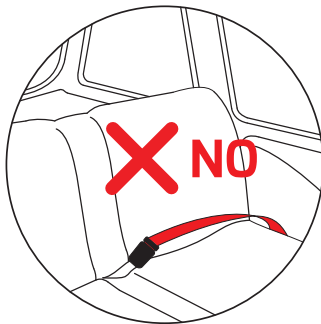

## Prepare Your Child Restraint

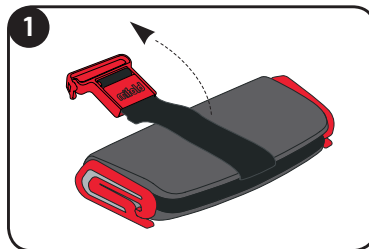

Open the child restraint and fold out the upper body.

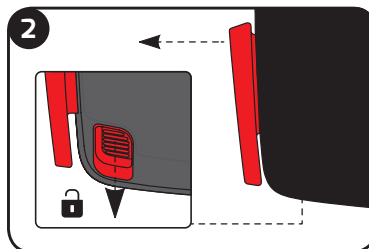

To unlock the lap belt guides, slide the Lap Belt Guide Release button forward.  
To lock the guides, release the Lap Belt Guide Release button.

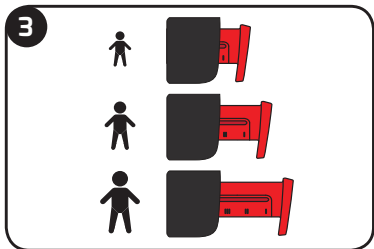

Extract the lap belt guides and position according to the chart.



To access the shoulder belt guide strap, pull open the shoulder belt guide buckle.



To shorten or lengthen the shoulder belt guide pull the strap in the desired direction.

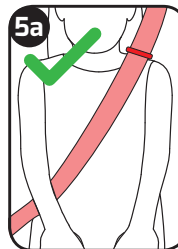
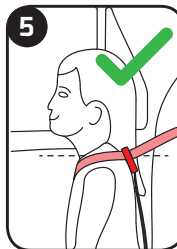

Ensure that the shoulder belt guide is positioned above and centred on your child's shoulder.

# Install Your Child Restraint

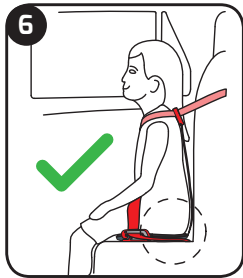

Ensure that the child restraint is laid flat and up against the back rest of the vehicle seat.

For contoured vehicle seats, position back of child restraint on contour and in contact with vehicle seat back.

Seat child on the child restraint with child's bottom and back in contact with the vehicle seat back cushion.

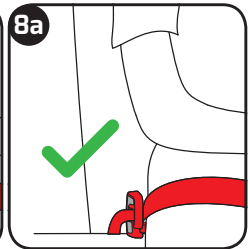
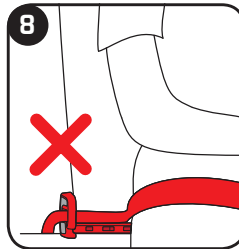
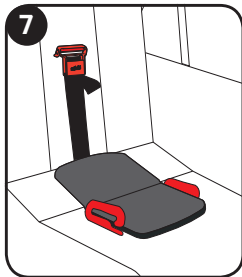

Position your child sitting upright on the child restraint and if necessary, slide lap belt guides into the position nearest to, but not touching the child's thigh. Pull out the lap belt guides to check they are locked into position.

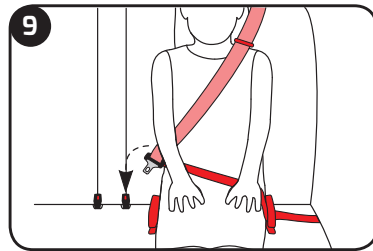

Extract the vehicle seat belt and pass it across the front of your child. Slide lap belt portion of vehicle seat belt through both lap belt guides and connect the seat belt tongue into the vehicle buckle.

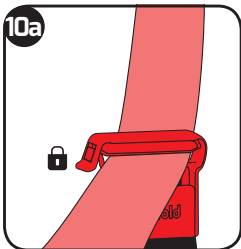
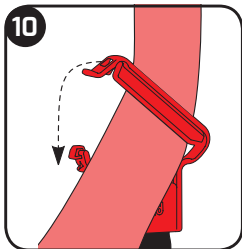

To position the shoulder belt guide, attach the shoulder belt guide to the diagonal portion of the vehicle seat belt, by opening the clip and inserting the seat belt. Then close the clip.

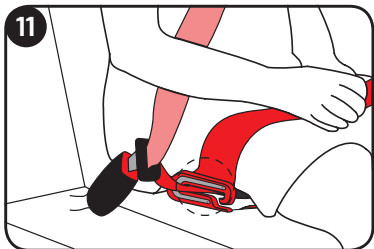

Insert the lap portion only of the vehicle seat belt through the red belt guides on each side of the child restraint.

**WARNING!** If the vehicle seat belt tongue is up against the red lap belt guide such that you cannot tighten the seat belt, this condition is unacceptable. You must use a different seat position.

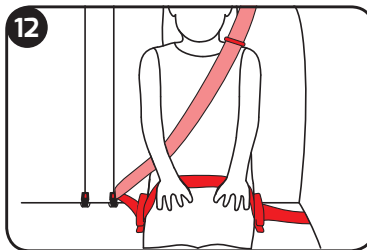

Ensure that the lap portion of the vehicle seat belt has passed through the lap belt slots on both sides of the child restraint.





Remove any twists or seat belt slack by pulling on the lap portion and then the diagonal portion of the adult seat belt.



Ensure that the lap portion is positioned over the child's lap and supported on the child's pelvis.

Pull up on vehicle shoulder belt to remove slack from lap portion of vehicle seat belt and snugly adjust lap belt around child.

Check that vehicle lap belt is low on hips and contacting thighs.



## Final checklist

However safe a child seat is, however well built it is, your child's safety depends on you carrying out the following checks before every journey:

- Check that the child restraint is facing forwards in the vehicle and in the direction of travel.
- Check that the vehicle seat belt is fitted correctly with the shoulder belt engaged with the shoulder belt guide, the lap strap is attached to the red lap belt guides, and the tongue is connected to the buckle.
- Check that the vehicle seat belt is not twisted or slack

**IMPORTANT!** Misusing your child seat will reduce the protection and safety you offer your child.

## Maintenance advice

The child restraint cover is not removable. In case of light staining, clean using a damp cloth or soapy water.



### Safety Warning



**Toxic cleaning fluids can cause illness. Never use bleach, do not iron, do not machine wash, do not tumble dry as this could damage the cover and require replacing.**

## Additional information

This child restraint is not approved for use on aircraft. For more information, contact the airline.

To dispose of your child restraint safely always render the seat unusable.

**IMPORTANT!** Make sure the instruction book is removed from the slot before cleaning.

## Notice

This child restraint is a “Universal” child restraint system. It has been approved in accordance with regulation ECE R44/04, and is suitable for general use in vehicles, and is compatible with the majority of vehicle seats.

- This child restraint is likely to fit if the vehicle manufacturer states that the vehicle approval specifies suitability for “Universal” child restraint systems.
- This restraint system is classified as “Universal” in accordance with the strictest approval criteria, whereas earlier models do not correspond to these new provisions.
- This restraint system can only be installed in vehicles with 3-point static or retractable seat belts that have been approved compliant with the UN/ECE No.16 or other equivalent standards.

If in doubt, contact the manufacturer of the restraint system.

© 2018 Carfoldio Ltd. Carfoldio™, mifold® and mifold the Grab-and-Go Child Restraint™, are registered trademarks of Carfoldio Ltd.

This innovative product is protected by patents and design registrations worldwide, including U.S. Pat. No. 9,376,088 and European Pat. No. 13 797 456.4-1503 and other patents pending. All pictures are illustrations. Actual product may vary.



**Distributed in the U.K. by:**

Whitestep Ltd.

45 Circus Road, London NW8 9JH

info@whitestep.co.uk | enquiry@whitestep.co.uk

Tel: +44 207 323 9514

Follow us on:



enquiry@whitestep.co.uk



www.askformifold.com



pinterest.com/mifold



facebook.com/mifolduk



www.twitter.com/mifolduk



instagram.com/mifold.uk

**Manufactured by:**

carFoldio Ltd.

Unit 2407, PO Box 6945

London, W1A 6US, England, U.K.

Tel: 0800 4714984 (from within the U.K.)

Tel: +44 207 866 2385 (International)

**mifold**<sup>®</sup>  
the Grab-and-Go Child Restraint™