

Instruction Manual Ver 1.00

SDE-080H

Vault



Thank you very much for purchasing a Snow Peak product. This product is a tent designed for camping. To use this product safely and correctly, please read these instructions carefully. After reading these instructions, keep this manual in a safe place for future reference. Although this product is expected to be complete and safe, please check that all accessory items are included before attempting to assemble the product. Practice assembling and handling the product in a safe location before using it while camping.

If you find anything in the instruction manual that is difficult to understand, or if you find a defect with the product, stop using it immediately and contact the dealers where you purchased the product or Snow Peak Customer Service.

■ Contents

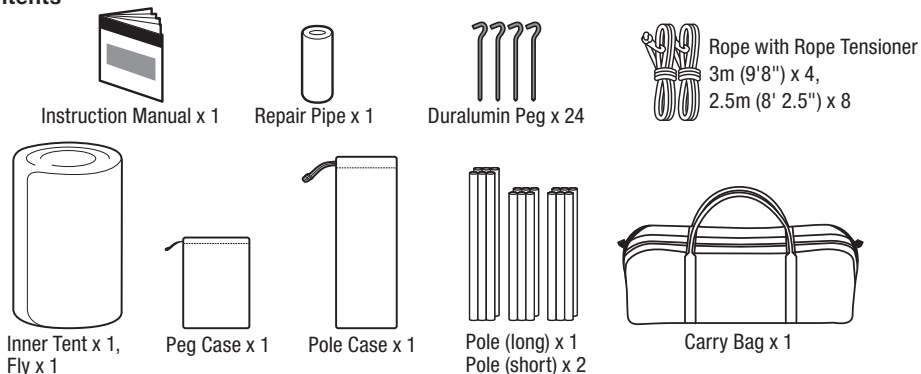

Safety Precautions Before use: please read thoroughly to ensure safety and to avoid accidents.

⚠ DANGER Misuse could easily result in a serious accident or death.

- The tent material is not flame-proof. Do not use combustion-based heat sources such as lanterns, stoves or heaters, or open flames such as matches, candles, lighters or cigarettes, inside the tent. The use of such heat or light sources inside a small enclosed space is very dangerous and may result in fire, oxygen deficiency or carbon monoxide poisoning.
- Do not keep fuel, or flammable items for replenishing the fuel, inside the tent.



⚠ WARNING Misuse could result in serious injury to the user.

- Pay close attention to the weather. If extreme weather is in the forecast, pack up camp and evacuate to a safe place.
- Do not bring heated items into the tent when they are at high temperatures. Inside the tent, very high temperatures may cause heatstroke. Pay close attention to the temperature, particularly when children are asleep inside the tent.
- Choose a flat, well-drained area with firm ground to pitch the tent. Choose an area where there is no chance of avalanches, landslides, wind gusts or sudden flooding.



⚠ CAUTION Misuse could result in injury to the user and/or damage to property.

- This product is not intended to be in permanent use.
- Sunlight can cause the surface of the Fly to heat up, potentially causing low-temperature burns.
- Do not assemble or use the tent close to a bonfire, fireworks, etc. Flying sparks can create holes in the tent fabric.
- Firmly hold the tent/tarp pole when assembling and disassembling the tent/tarp. Unexpected accidents may occur due to the Pole ends recoiling, etc, so ensure that the surroundings are safe, with no other people in the vicinity.
- Firmly secure the Pegs, Guy Lines, etc.
- If the tent is left in the sun for long periods, the materials may fade in color or the fabric may deteriorate and lose strength. Do not leave the tent set up permanently.

How to attach the rope with the tensioner to the fly; and how to secure the pegs in the proper direction.

*Follow the instructions on the next page (P. 3).

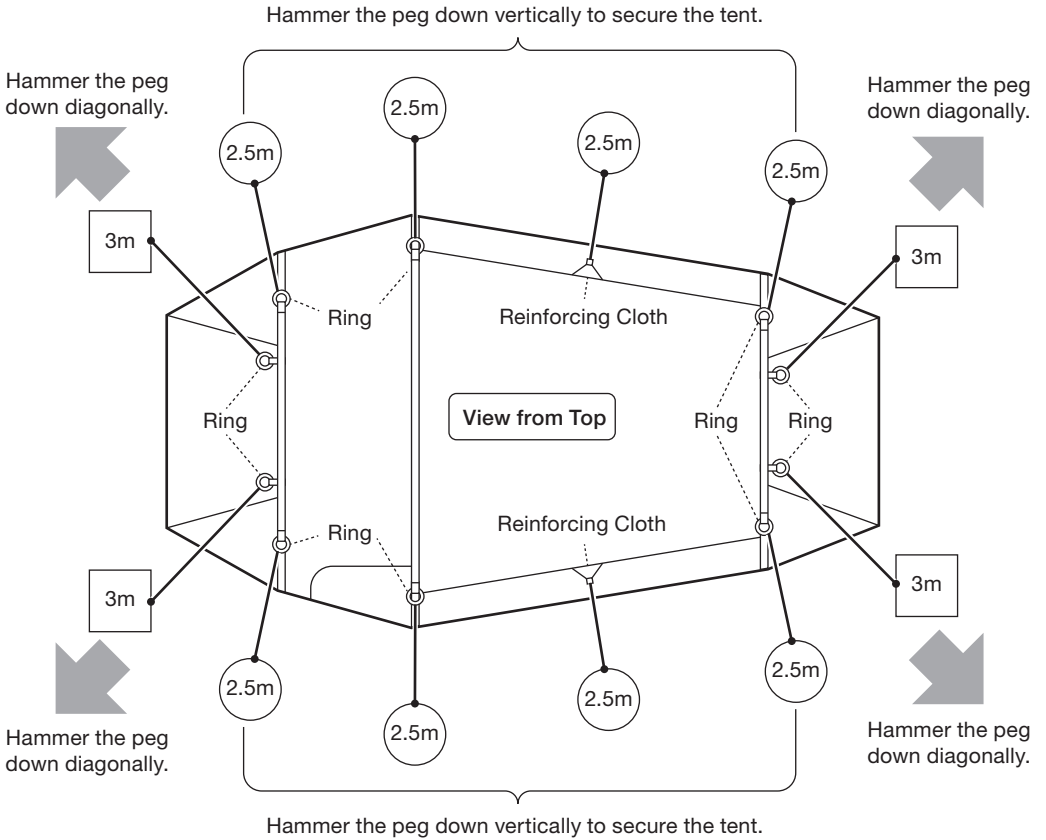

How to attach the rope

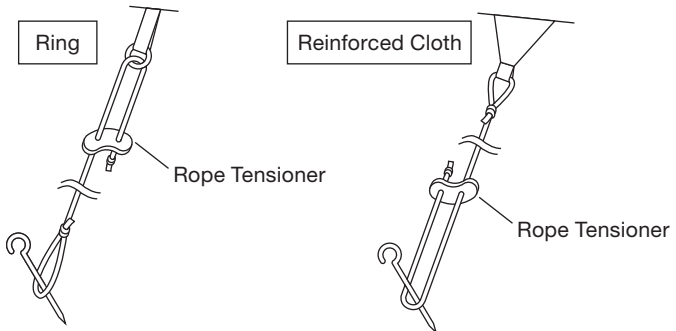

Set-up Procedure Make sure that two or more people take part in the set-up.

1 Spread the Fly (beige color) on a flat area.

*Typically, the Vestibule should face downwind. If the Vestibule faces windward, not only will wind and rain blow into the main entrance, but sudden and strong gusts may cause damage to the tent when opening the door.

2 Extend Pole (long) x 1 and Pole (short) x 2 and connect them firmly.

*Make sure to connect them without leaving gaps at the joints.

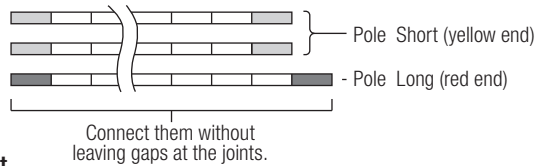

3 Check the position marked with ★ and insert the Pole into the Sleeve. Make sure to match the end colors of the Sleeve and the Pole.

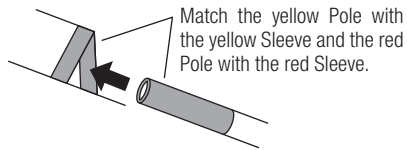

4 Check the position marked with ▲ and insert the pin into the end of the Pole, at the corner of the Fly. Match the colors of the Pole end and corner tape.

Match the yellow Pole with the yellow Corner Tape, and the red Pole with the red Corner Tape, and insert.

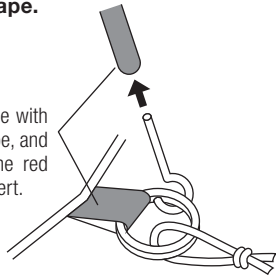

5 Insert the pin on the opposite side.

*Slowly insert the pin into the end of pole while adjusting the sleeve so it is positioned in the center. If the pin is inserted with too much force from one side, the other side may curve widely and damage the Pole. Be sure to communicate with your set-up partner during this procedure.

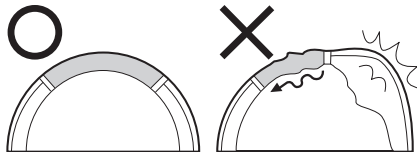

6 Wrap [I] tape around the pole. Hook [II] to the pole.

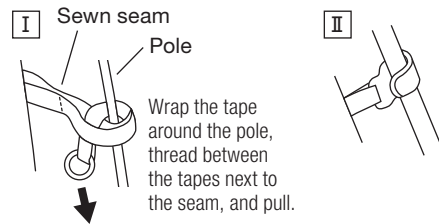

7 Secure to each corner loop, following the order shown below.

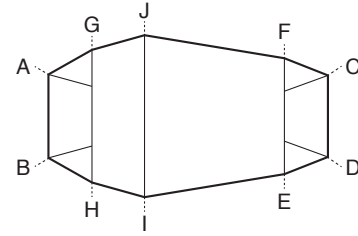

Make sure there is no slack when pegging C and D down.

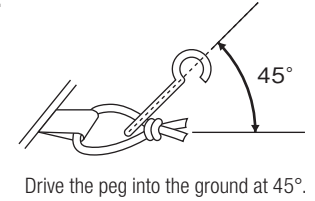

8 Attach the rope according to the P5 and also peg down the rope.

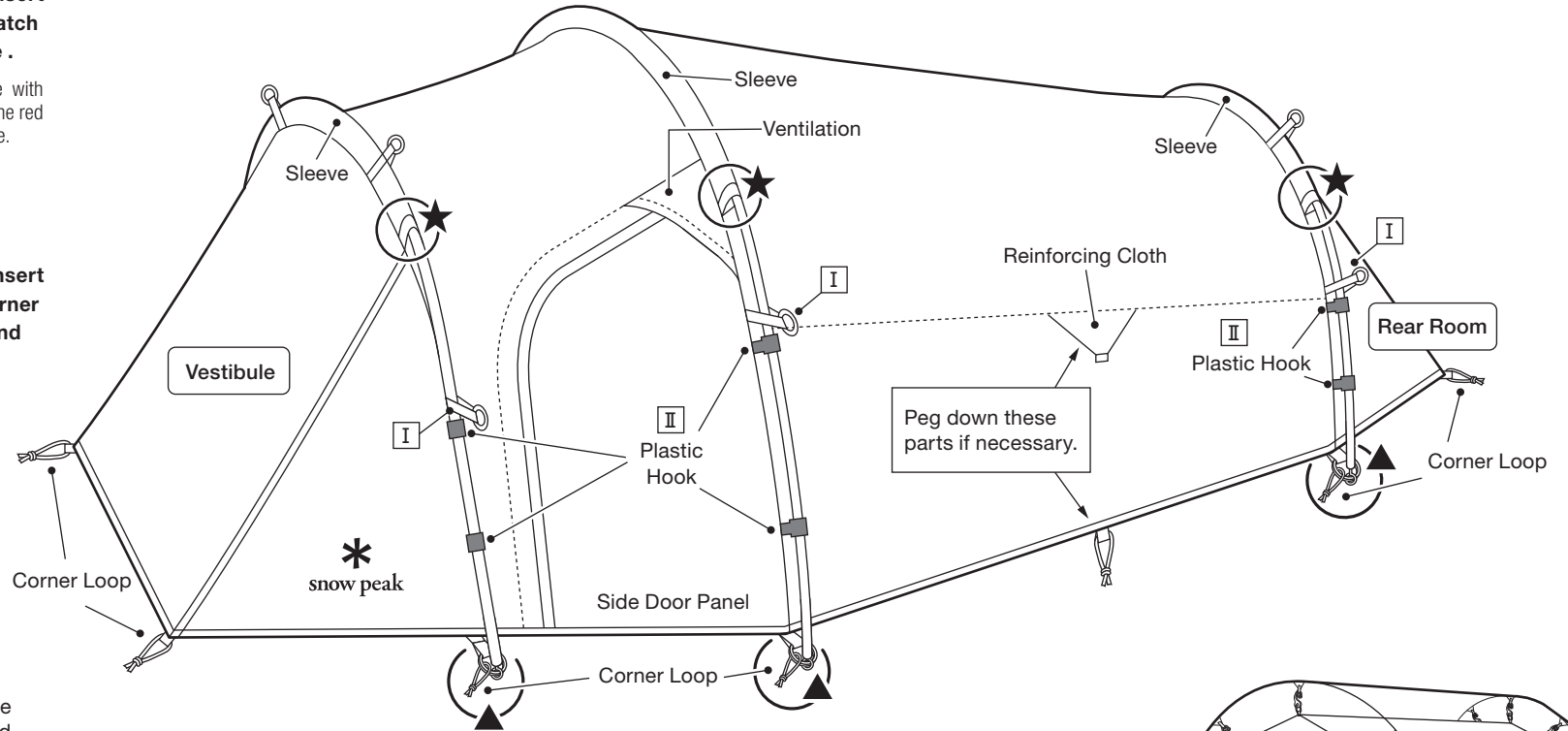

9 Hang the inner tent inside the fly sheet.

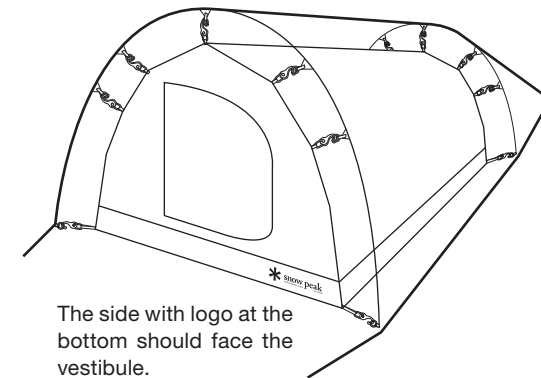
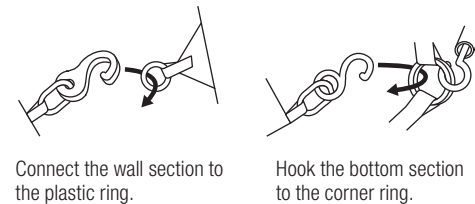

Docking

Purchase two tents for easy docking.

*Please note: complete docking is not possible. The docking function does not prevent rainwater from entering. Release the docking connection if rain is anticipated.

- 1** Connect the tents at the vestibules, the backrooms or the vestibule and the backroom (any combination works). Secure the connection with the Velcro strap at two points on each side, four points total.

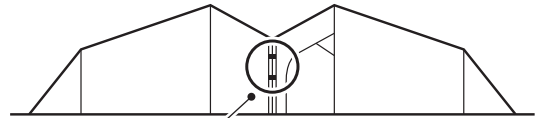
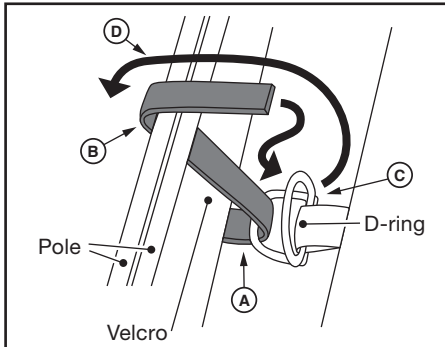

- Pass the tape through the first D-ring.
- Wrap around the two Poles.
- Pass the tape through the other D-ring.
- Secure with Velcro.

- 2** Enter the room and stack the two front and side panels, then roll them up.

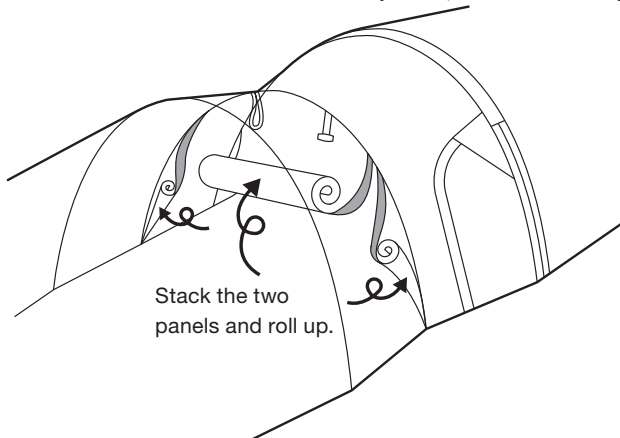

- 3** Cross the ropes with a rope tensioner, then secure with a peg and tighten tensioner.

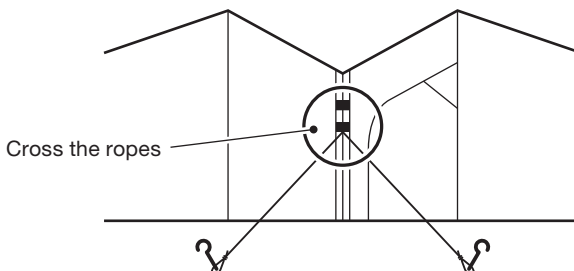

Water-Repellent and Waterproof Functions

- A combination of Polyester fabric is used in this product. Both materials are treated with a high-quality, water-repellent finish. However, the level of water-repellent capacity and durability may vary slightly due to the characteristics of each material.
- The water-repellent finish will lose effectiveness after repeated use. When the water repellence decreases, please use a water-repellent spray purchased from your local outdoor gear retailer. When using such sprays, please follow the product's instructions.
- Materials with high waterproof capacity are used in this product. However, if the materials are in contact with pools of water on the ground for long periods, the water may be absorbed into the material, potentially resulting in discoloration.

Regarding the Effect of Ultraviolet Rays

- A UV protection treatment has been applied to the fly material. The UV protection treatment will lessen the permeation of ultraviolet rays, which are harmful to humans, and slow the deterioration of the Fly.
*The UV protection treatment does not completely shield humans from ultraviolet rays or stop the deterioration of the material's strength.
- When the tent material is exposed to sunlight for long periods, color degradation or strength deterioration may occur. Do not leave the product assembled permanently.
- If the material deteriorates due to ultraviolet rays and is badly damaged, it may become irreparable.

Maintenance & Storage

- A combination of Polyester fabric is used for this product. Taking the material characteristics into consideration, we adopted processing and color patterns that will result in less color migration. However, depending on storage conditions, slight color migration may occur. Do not store the product while it is wet.
- Before storing, the product should be cleaned and dried sufficiently. If the product is stored when wet, the build-up of mold, bad odors, color migration and material deterioration will occur. Dry the product sufficiently in a breezy and shaded area and clean the surface with a soft brush before storing.
*Do not flip the tent over with poles still in the sleeves, as the poles may break, and cloth damage may occur.
- Clean and dry the surface of the poles before storing. If stored when wet, corrosion may occur, resulting in strength deterioration. Keep the joints clean and apply a small amount of silicone lubricant; applying an excessive amount of lubricant will stain the cloth. Ensure that the cords inside the poles are not pulled unnecessarily.
- Store the product in a well-ventilated area, away from heat and moisture.
- Using the zipper when it is covered with mud, sand or dust may cause wear or damage.
Clean the zipper with a brush before use. Apply small amounts of silicone lubricant to the zipper regularly to ensure smooth movement. Do not apply excessive amounts of lubricant as it will leave stains on the cloth.
- Minor damage to the cloth can be mended with repair tape that can be purchased from your local outdoor gear retailer. Refer to the product instructions for the correct use of such repair tape.
- Depending on the conditions during use, the tent material may deteriorate over a wide area, losing its durability and becoming irreparable.
- To maximize the longevity of this product, regularly check and maintain the product (including all accessories such as the pegs).

FAQ

Q: What can be done if a pole is broken while the tent is in use?

A: For an emergency treatment, use a repair pipe or splint, and secure with vinyl tape. Or fully disassemble the tent for repair.

Q: What can be done if the tent/tarp cloth is damaged or rips while the tent is in use?

A: Seal the area with packing tape on both sides or use a tent repair kit that can be purchased from your local outdoor gear retailer. When using a repair kit, read the instructions carefully.

Q: What can be done when the water-repellent finish degrades?

A: The water-repellent finish will lose its effectiveness with repeated use. When the material's water repellence decreases, please use a water-repellent spray that can be purchased from your local outdoor gear retailer. When using such sprays, please follow the product's instructions.

Q: What can be done if mold develops on the tent material?

A: Wipe the affected area with a dry cloth and sterilize with alcohol. When the material has a color change due to mold, this color change cannot be removed. Removing mold with excessive force may result in further deterioration of the material and the coating finish.

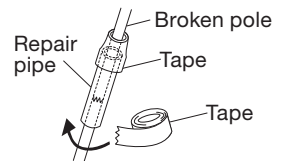

Regarding Warranty

The specifications of Snow Peak products are determined based on field testing and quality control, ensuring proper function and longevity of every product. If apparent defects in the manufacturing of the product are found, the defective product will be repaired or exchanged free of charge. Damages, as follows, are not covered under warranty.

1. Damage caused by improper use.
2. Material deterioration caused by age or the influence of ultraviolet rays.
3. Damage caused by modifications or rough handling.
4. Damage caused by unforeseen accidents.
5. Damage not caused by defects in the manufacturing process.
6. Damage caused by dust or rust.
7. Damage or defects caused when dismantling the product.
8. Damage and defects caused by dropping or other shocks to the product.
9. Defects, breakage or deterioration of replaceable parts.
10. Damage caused by use of the product in combination with other maker's products.

Regarding Repair

- If a professional repair is necessary, please contact the dealer where the product was sold or Snow Peak Customer Service.
- Please dry and clean the product before sending it for repair.
- Please stick a memo onto the damaged area of the product. In the memo, include details explaining the circumstances that led to the damage.
- The cost of repair will be determined as follows:
 1. If the damage is subject to warranty, transportation cost (both ways) and repair cost will be covered by Snow Peak.
 2. If the damage is not subject to warranty, transportation cost (both ways) and repair cost will be covered by the customer.

Specifications

- Material: Fly/75D Polyester Taffeta, PU coating, Waterproof rating: 1,800mm minimum, water-repellent finish, UV protection treatment, Inner Tent/68D Polyester Taffeta, Bottom/210D Polyester Oxford, PU coating, Waterproof rating: 1,800mm minimum; Pole /A6061 (Φ13mm(0.51"))
- Set Contents/Tent, Pole Long (x1), Pole Short (x2), Duralumin Peg (x24), Rope with Rope Tensioner (3m (9'8") x 4, 2.5m (8' 2.5') x 8), Repair Pipe (x1), Carry Bag, Pole Case, Peg Case
- Carry Bag Size 66x25x25(h)cm(26"x9.8"x9.8")
- Weight : 7.9kg (17.4lbs)

- Capacity: 4 persons

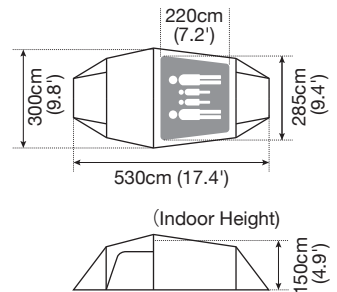

For question or concerns
contact the Snow Peak
Customer Service Department.

Snow Peak USA Inc.

☎ +1 503-697-3330 (9:00-17:00)

Email: info@snowpeak.com

Snow Peak USA Inc.

404 NW 23rd Ave., Portland Oregon, 97210, USA

Tel. +1 503-697-3330 @snowpeakusa

www.snowpeak.com

Snow Peak, Inc.

456 Nakanohara, Sanjo-shi Niigata 955-0147 Japan

Tel. +81 256-46-5858 Fax. +81 256-46-5860

www.snowpeak.co.jp

MADE IN VIETNAM