

Instruction Manual Ver 1.00

SDE-003RH

Amenity Dome L



Thank you very much for purchasing a Snow Peak product. To use this product safely and correctly, please read these instructions carefully. After reading these instructions, keep this manual in a safe place for future reference. Although this product is expected to be complete and safe, please check that all accessory items are included before attempting to assemble the product. Practice assembling and handling the product in a safe location before using it in the field. If you find anything in the instruction manual that is difficult to understand, or if you find a defect with the product, stop using it immediately and contact the dealers where you purchased the product or Snow Peak Customer Service.

■ Contents

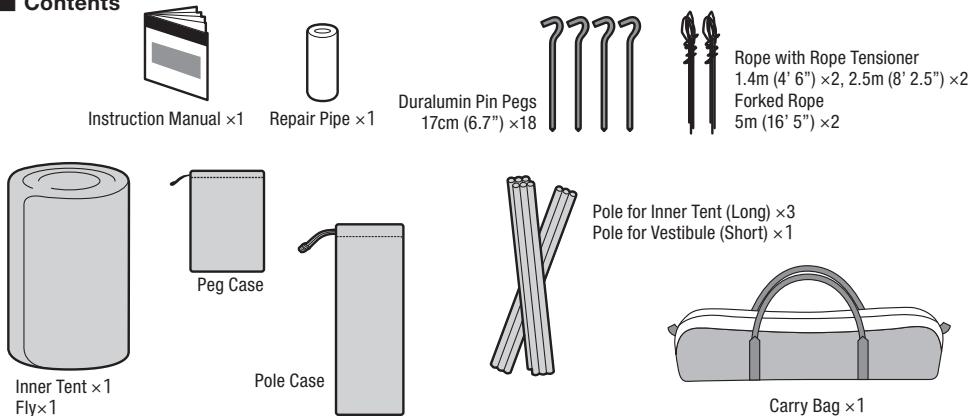

The set contents are based on setup in general conditions. If you bring sturdy and long pegs and ropes, you can adjust to various weather conditions. Pegs and ropes are essential items, so it is recommended to always carry a spare.

● Part Names

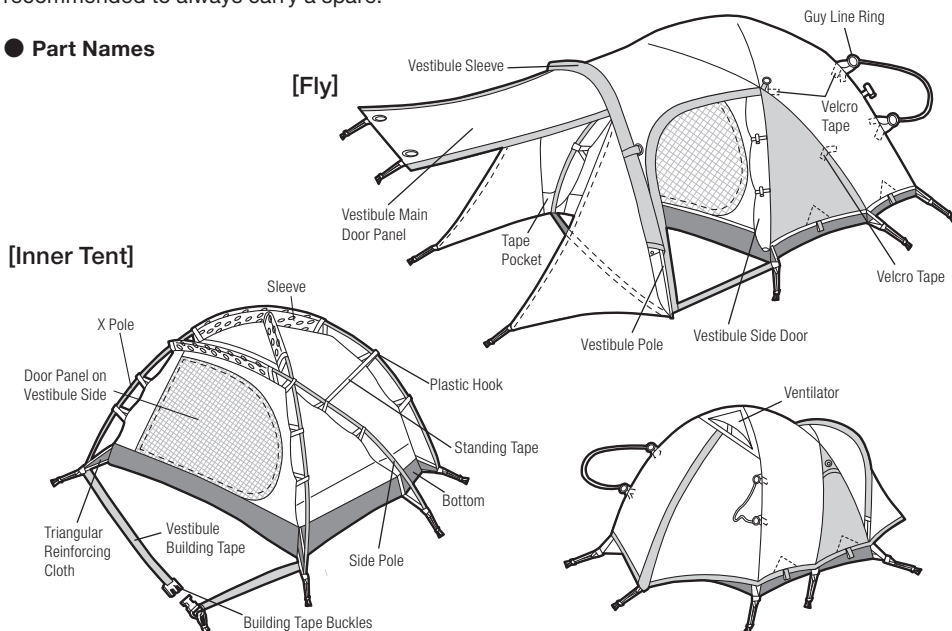

*If the Vestibule Door Panel is to be kept open, additional Poles, Ropes and Pegs are required.

Before use: please read thoroughly to ensure safety and to avoid accidents.

 **DANGER** Misuse could easily result in a serious accident or death.

 **WARNING** Misuse could result in serious injury to the user.

 **CAUTION** Misuse could result in injury to the user and/or damage to property.

Important Information

 **DANGER** Misuse could easily result in a serious accident or death.

● The tent material is not flame-proof. Do not use combustion-based heat sources such as lanterns, stoves or heaters, or open flames such as matches, candles, lighters or cigarettes, inside the tent. The use of such heat or light sources inside a small enclosed space is very dangerous and may result in fire, oxygen deficiency or carbon monoxide poisoning.



● Do not keep fuel, or flammable items for replenishing the fuel, inside the tent.



 **WARNING** Misuse could result in serious injury to the user.

● Pay close attention to the weather. If extreme weather is in the forecast, pack up camp and evacuate to a safe place.



● Do not bring heated items into the tent when they are at high temperatures. Inside the tent, very high temperatures may cause heatstroke. Pay close attention to the temperature, particularly when children are asleep inside the tent.

● Choose a flat, well-drained area with firm ground to pitch the tent. Choose an area where there is no chance of avalanches, landslides, wind gusts or sudden flooding.

 **CAUTION** Misuse could result in injury to the user and/or damage to property.

● This product is not intended to be in permanent use.

● Sunlight can cause the surface of the Fly to heat up, potentially causing low-temperature burns.

● Do not assemble or use the tent close to a bonfire, fireworks, etc. Flying sparks can create holes in the tent fabric.

● Firmly hold the tent pole when assembling and disassembling the tent. Unexpected accidents may occur due to the Pole ends recoiling, etc, so ensure that the surroundings are safe, with no other people in the vicinity.

● Firmly secure the Pegs, Guy Lines, etc.

● If the tent is left in the sun for long periods, the materials may fade in color or the fabric may deteriorate and lose strength. Do not leave the tent set up permanently.

Preparations Before Use

First Time Use

We have thoroughly checked this product for quality, however, please do a trial set up before actual use to ensure full understanding of the correct usage of the accessories and instructions. If any defects are found, please contact the dealer where the product was purchased or Snow Peak Customer Service.

1. Sealing with Seam Sealer

*Seam sealer is not included in this product. When using, please purchase seam sealant from a local outdoor gear retailer.

A waterproofing treatment with seam taping has been applied to the stitching of the tent. However, the ventilator and fasteners on the Fly and a part of the bottom sheet cannot be treated with the seam tape due to their inherent design. Though capable during periods of normal rain, long spells of heavy or driving rain, or prolonged contact with water pools on the ground, may result in the penetration of water along the stitching. In such cases, the application of a seam sealer is recommended. Apply the seam sealer lightly on both sides along the stitching and dry completely. The seam sealer will cure with time. As the seam sealer wears off, re-apply as necessary. We do not provide a sealing service. However, to maintain the tent in its best condition, application of seam sealer by the user is highly recommended.

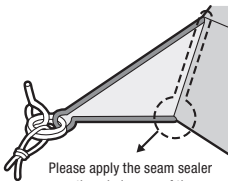

Please apply the seam sealer over the whole area of the bottom corner of the Inner Tent.

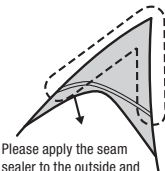

Please apply the seam sealer to the outside and inside surface of the back ventilator.

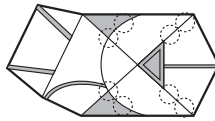

Apply the seam sealer to the eight places marked with a circle on the Velcro Tape used to attach the Fly to the surface.

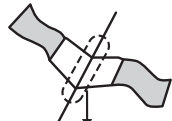

Please apply the seam sealer on both surfaces of the Velcro Tape, on the backside of the Fly.

2. How to attach the tensioning Guy Lines onto the Fly

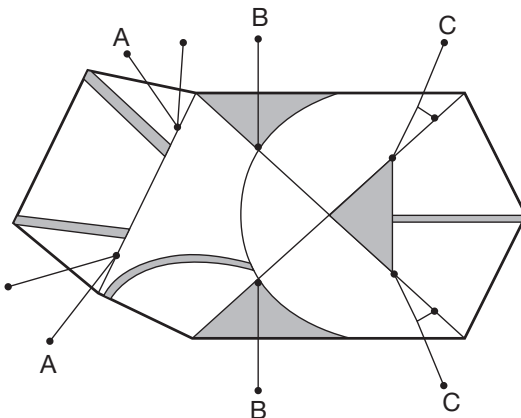

- A. Forked Ropes 5m (16' 5") × 2
- B. 2.5m (8' 2.5") × 2
- C. 1.4m (4' 6") × 2

There are loops on the roof of the tent for hanging small items. Each loop can bear up to 1kg (2.2 lbs) in weight.

Set-up Procedure

- 0) Make sure that two or more people take part in the set-up.
- 1) Spread the Inner Tent on a flat area.

There are two entrances to the Inner Tent; the side that has the Building Tape is the Vestibule side and will become the main entrance. It is necessary to decide the location of the Vestibule according to the predicted direction of the wind and rain. Typically, the Vestibule should face downwind. If the Vestibule faces windward, not only will wind and rain blow into the main entrance, but sudden and strong gusts may cause damage to the tent when opening the door.
- 2) There are three Inner Tent Poles. Extend the two Poles with the yellow ends and connect them firmly. Make sure to connect them without leaving gaps at the joints.
- 3) Slowly and one-by-one, insert the two yellow-ended Poles through the sleeves with the yellow marks. (Hereafter this is called the 'X'.) (fig. A)
- 4) Extend the remaining Pole for the Inner Tent (hereafter called the 'Side Pole') and connect firmly.
- 5) Insert the Side Pole slowly into the sleeve with the green mark (fig. B).
The Side Pole should go over the X Pole (fig. C).

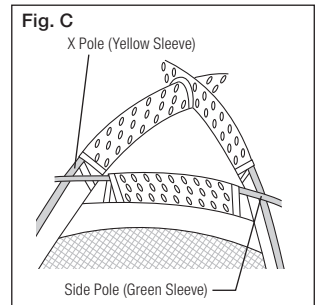
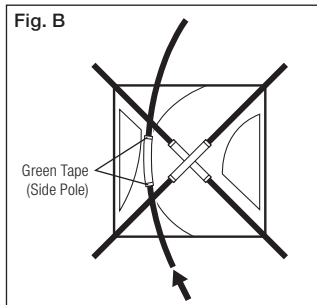
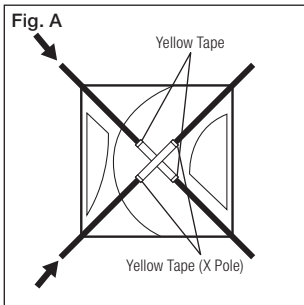

- 6) Insert a pin into one end of the X Pole (the corner tape for the X Pole is yellow) (fig. D).

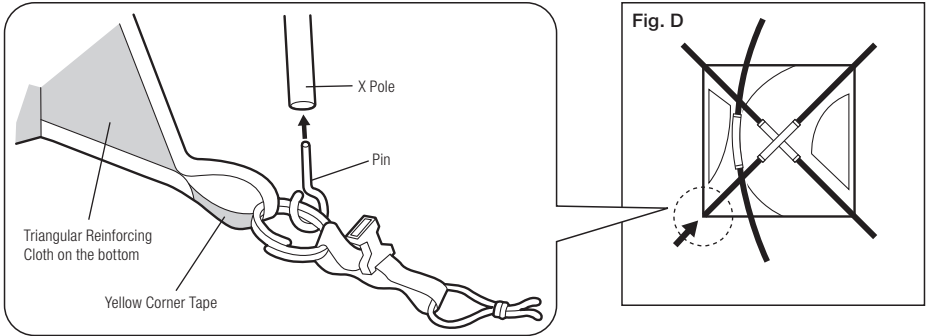

- 7) Insert the additional pin to the other end of the X Pole, which is located diagonally opposite the first end (fig. E). Insert the pin slowly into the X Pole end while adjusting so the sleeve is positioned in the center. If the pin is inserted with too much force from one side, the other side may curve widely and cause damage to the X Pole (fig. F). Communicate with your set up partner during this procedure.

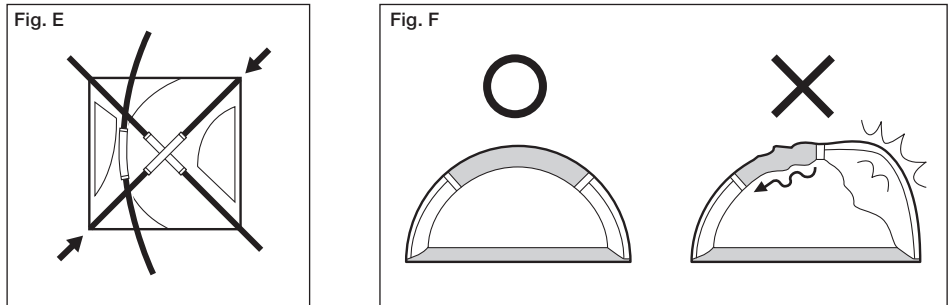

- 8) Repeat the procedure above on the other end of the X Pole and lift the tent (fig. G). Keep the Door Panel and Side Panel half-open so that air can enter the room and aid in the lifting of the tent.

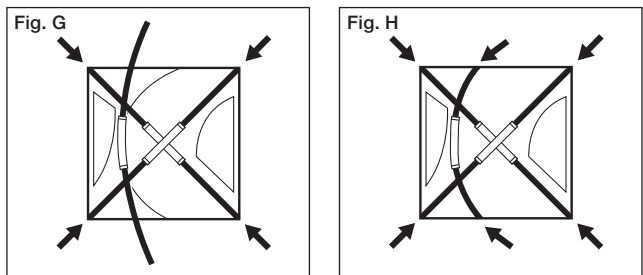

- 9) Insert the pins into both ends of the Side Pole (corner tape for the Side Pole is green) (fig. H).

- 10) Attach all the Plastic Hooks to the corresponding Poles (fig. I).
- 11) Close both door panels, front and back. Insert the pegs into the loops at the six ends of each corner. Peg down the Inner Tent by following the numbers, and by pulling lightly to stretch out any slack at the bottom of the tent (fig. J).
- *Peg the tent down all the way, but do not use undue force that may bend or break the pegs.
 - *Hammer gently, and if you find any obstacles such as stones, change the entrance point of the peg as needed.
 - *The door may not close later if it is open when pegging down.

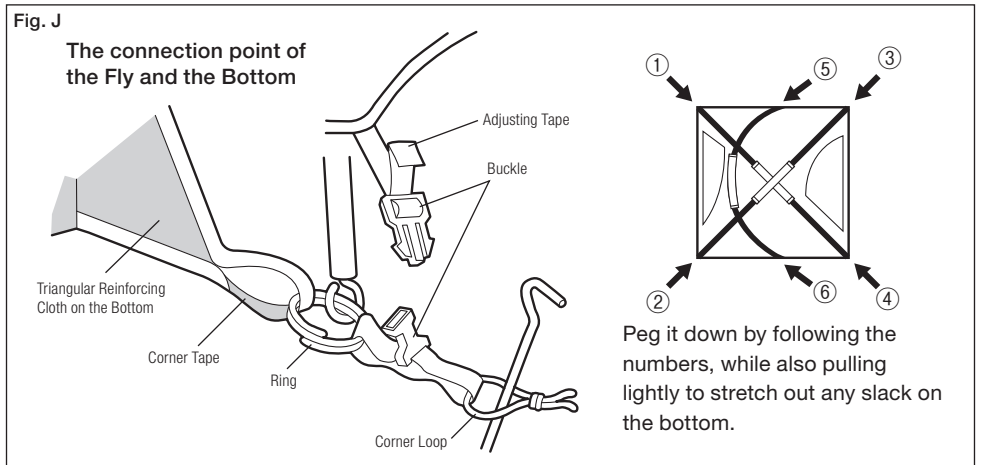
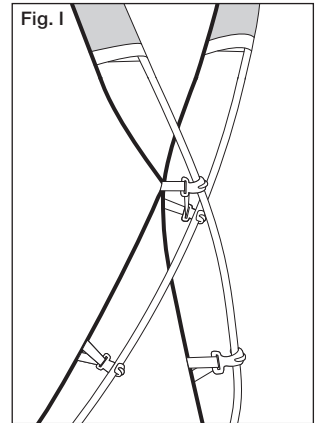

- 12) Check the direction of the Vestibule and Back Room and lay the Fly in place (fig. K).
- *Velcro Tape is attached to the inside of the Fly (at the cross-section of the Pole and the Guy Line Reinforcing Cloth) to keep the Fly in place. Wind the Velcro Tape around the Pole to secure it. When taking down the tent, make sure to remove the Velcro Tape. If the Fly is forcefully pulled while the Velcro Tape is still wound on the Pole, the Velcro Tape may be damaged.

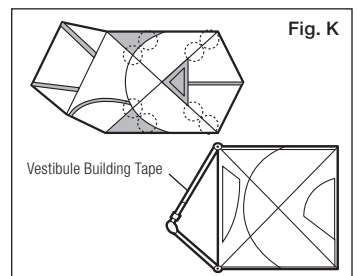

- *Ensure the Vestibule Building Tape is connected.
- 13) Extend the Vestibule Pole and connect firmly (1 pcs).
- *Make sure to connect firmly without leaving a gap at the joint.

- 14) Slowly insert the Vestibule Pole into the sleeve of the Vestibule Fly, then insert the pins into both ends of the Pole (fig. L).
 - 15) Connect the six Buckles on the edge of the Fly to the Buckles on the Bottom Rings. After connecting all of the Buckles, pull the Adjusting Tape to apply tension and unruﬄe the Fly (fig. J).
- *Do not pull the tape too much: excessive pulling may cause damage to the Fly.

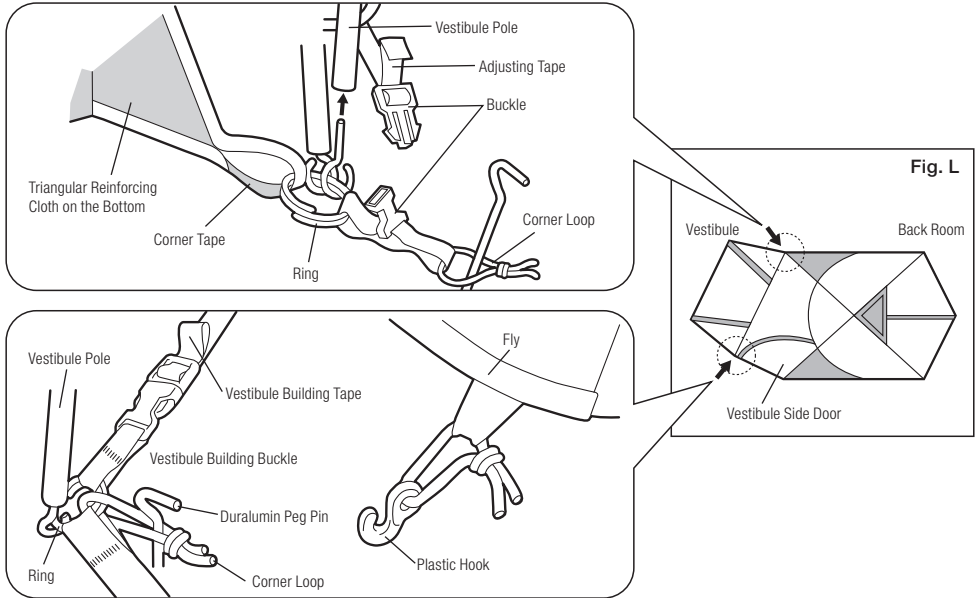

- 16) Attach the Plastic Hook on the corner of the Vestibule Side Door to the Ring (fig. L).
 - 17) Pull the edges of the Vestibule and Back Room and then insert the Pegs through the rubber Corner Loops and hammer down (fig. M).
- *Do not pull the edges too much, excessive pulling may overload the fastener and cause damage.

- 18) After pegging down all the corners, disconnect the Buckle of the Vestibule Building Tape and store it in the Building Tape Pocket (fig. N).

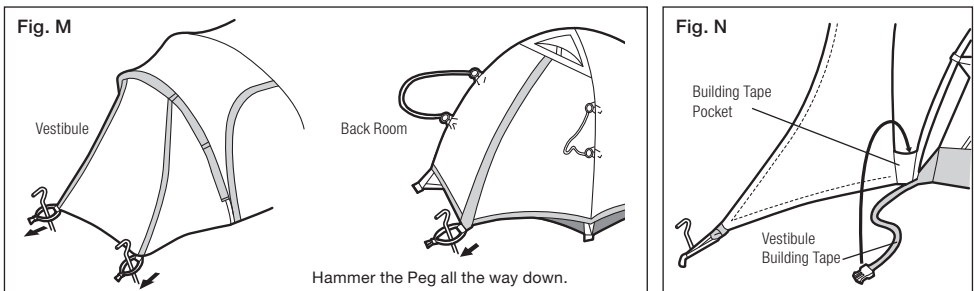

- 19) Stretch each tensioning Guy Line and peg it down (fig. O).
- 20) Pull the Rope tensioner on the Guy Lines to increase the tension (fig. P).

*Do not pull the rope too much. If pulled too far, the Fly may be overloaded or damaged.

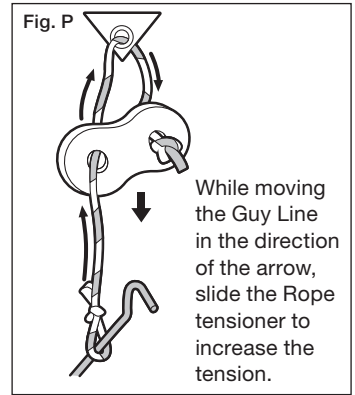
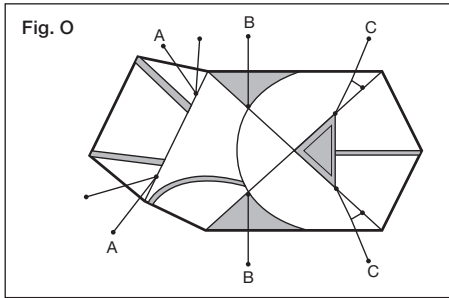

■ Precautions for Storage

- When taking the tent down, begin by disconnecting the Vestibule Building Tape (fig. K).
- When removing the Pole from the pins, the Pole may recoil. Use your hands to keep the Pole steady until it straightens.
- When removing the Side Pole and the X Pole from the pins, leave the Plastic Hooks in place. (Remove the Plastic Hooks only after all the Poles have been removed from the pins.)
- When removing the Pole from the sleeve, push it out: if the Pole is pulled out then it may become disconnected inside the sleeve. The disconnection of the Pole inside the sleeve may cause damage to the cloth.
- Fold the Pole from the center to the edges. If folded from the edge, the cord can be overstretched, which may cause elongation or breakage. If elongation occurs, the cord will lose the power to hold the Pole in place, potentially causing the Pole to break. Check the tension of the cord regularly (fig. Q).

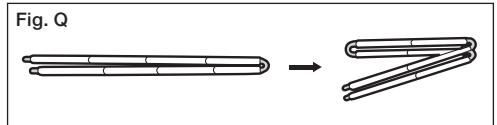

■ How to store the Tent in the Carry Bag

- ① Fold the Inner Tent and the Fly according to the length of the Carry Bag and place them inside it.
- ② Store the Poles and the pegs in their cases, then place the cases in the Carry Bag. If you store the Poles and Pegs without putting them in the case, it may damage the products or Carry Bag.

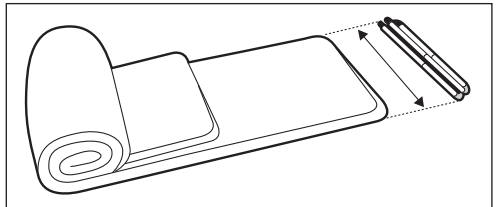

Regarding Condensation

Mist is a collection of water droplets suspended in the air that turns into condensation in rapidly falling temperatures. In smaller spaces such as the inside of a tent, the concentration of water vapor is higher than in an ordinary room and frequently results in more condensation. Additionally, water accounts for 60 percent of the human body and is released through breathing and perspiration. This also causes the amount of water vapor in the tent to increase, resulting in more condensation. Inside the tent, condensation can commonly be found on materials that have are highly waterproof, such as the Fly or the Bottom Sheet. Depending on the surrounding conditions, it may be impossible to avoid condensation completely, even with the use of waterproof materials. To reduce condensation, it is recommended that you allow steady ventilation while the tent is in use.

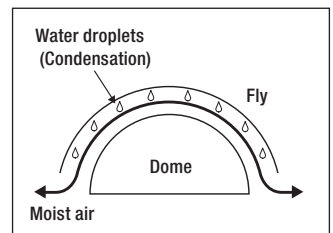

Water-Repellent and Waterproof Functions

- A combination of Polyester fabric is used in this product. Both materials are treated with a high-quality, water-repellent finish. However, the level of water-repellent capacity and durability may vary slightly due to the characteristics of each material.
- The water-repellent finish will lose effectiveness after repeated use. When the water repellence decreases, please use a water-repellent spray purchased from your local outdoor gear retailer. When using such sprays, please follow the product's instructions.
- Materials with high waterproof capacity are used in this product. However, if the materials are in contact with pools of water on the ground for long periods, the water may be absorbed into the material, potentially resulting in discoloration.

Regarding the Effect of Ultraviolet Rays

- A UV protection treatment has been applied to the Fly material. The UV protection treatment will lessen the permeation of ultraviolet rays, which are harmful to humans, and also slow the deterioration of the Fly.
*The UV protection treatment does not completely shield humans from ultraviolet rays or stop the deterioration of the material's strength.
- When the tent material is exposed to sunlight for long periods, color degradation or strength deterioration may occur. Do not leave the product assembled permanently.
- If the material deteriorates due to ultraviolet rays and is badly damaged, it may become irreparable.

Maintenance & Storage

- A combination of Polyester fabric is used for this product. Taking the material characteristics into consideration, we adopted processing and color patterns that will result in less color migration. However, depending on storage conditions, slight color migration may occur. Do not store the product while it is wet.
- Before storage, the product should be cleaned and dried sufficiently. If the product is stored when wet, the build-up of mold, bad odors, color migration and material deterioration will occur. Dry the product sufficiently in a breezy and shaded area and clean the surface with a soft brush before storing.
*Do not flip the tent over with Poles still in the sleeves, as Pole breakage and cloth damage may occur.
- Clean and dry the surface of the Poles before storing. If stored when wet, corrosion may occur, resulting in strength deterioration. Keep the joints clean and apply a small amount of silicone lubricant; applying an excessive amount of lubricant will stain the cloth. Ensure that the cords inside the Poles are not pulled unnecessarily.
- Store the product in a well-ventilated area, away from heat and moisture.
- Using the zipper when it is covered with mud, sand or dust may cause wear or damage. Clean the zipper with a brush before use. Apply small amounts of silicone lubricant to the zipper regularly to allow for smooth movement. Do not apply excessive amounts of lubricant as it will leave stains on the cloth.
- Slight damage to the cloth can be mended with repair tape that can be purchased from your local outdoor gear retailer. Refer to the product instructions for the correct use of such repair tape.
- Depending on the conditions during use, the tent material may deteriorate over a wide area, losing its durability and becoming irreparable.
- To maximize the longevity of this product, regularly check and maintain the product (including all accessories such as the pegs).

FAQ

Q: What can be done if the Pole is broken while the tent is in use?

A: For emergency treatment, use a repair pipe or splint, and fix with vinyl tape. Or disassemble the tent for repair.

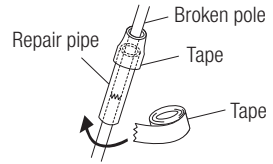

Q: What can be done if the Inner Tent cloth is damaged or rips while the tent is in use?

A: Seal the area with packing tape on both sides or use a tent repair kit that can be purchased at your local outdoor gear retailer. When using a repair kit, read the instructions carefully.

Q: What can be done when the water-repellent finish degrades?

A: The water-repellent finish will lose its effectiveness with repeated use.

When the material's water repellence decreases, please use a water-repellent spray that can be purchased at your local outdoor gear retailer. When using such sprays, please follow the product's instructions.

Q: What can be done if mold develops on the tent material?

A: Wipe the affected area with a dry cloth and sterilize with alcohol. When the material has a color change due to mold, this color change cannot be removed. Removing mold with excessive force may result in further deterioration of the material and the coating finish.

Regarding Warranty

The specifications of Snow Peak products are determined based on field testing and quality control, ensuring proper function and longevity of every product. If apparent defects in the manufacturing of the product are found, the defective product will be repaired or exchanged free of charge. Damages, as follows, are not covered under warranty.

1. Damage caused by improper use.
2. Material deterioration caused by age or the influence of ultraviolet rays.
3. Damage caused by modifications or rough handling.
4. Damage caused by unforeseen accidents.
5. Damage not caused by defects in the manufacturing process.
6. Damage caused by dust or rust.
7. Damage or defects caused when dismantling the products.
8. Damage and defects caused by dropping or other shocks to the products.
9. Defects, breakage or deterioration of replaceable parts.
10. Damage caused by use of the product in combination with other maker's products.

Regarding Repairs

- If a professional repair is necessary, please contact the dealer where the product was sold or Snow Peak Customer Service.
- Please dry and clean the product before sending it for repair.
- Please stick a memo onto the damaged area of the product. In the memo, include details explaining the circumstances that led to the damage.
- The cost of repair will be determined as follows:
 1. If the damage is subject to warranty, transportation cost (both ways) and repair cost will be covered by Snow Peak.
 2. If the damage is not subject to warranty, transportation cost (both ways) and repair cost will be covered by the customer.

The unit is in cm (feet)

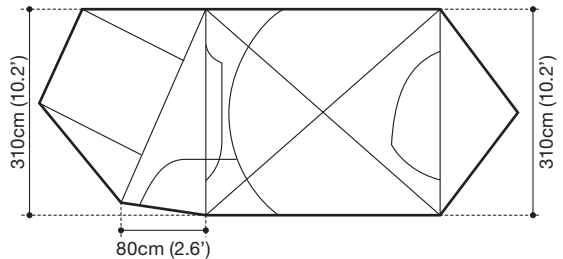
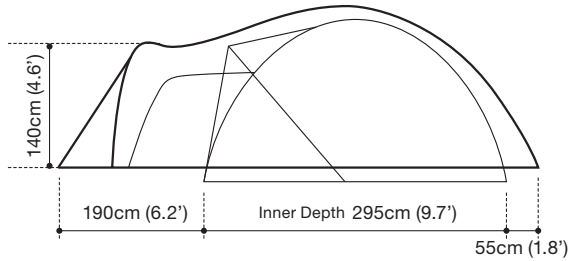
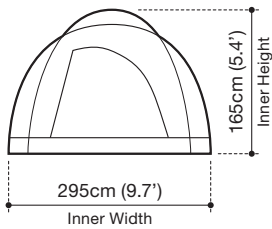

Specifications

SDE-003RH Amenity Dome L

- Material: Fly / 75D Polyester Taffeta, PU coating, Waterproof rating: 1,800mm minimum, Teflon water-repellent finish, UV protection treatment; Inner Wall / 68D Polyester Taffeta; Bottom / 210D Polyester Oxford • PU coating, Waterproof rating: 1,800mm minimum; Pole / Duralumin A7001+A6061 (Φ12mm (0.47") + Φ13mm (0.51") + Φ14.5mm (0.57"))
- Contents: Tent; Tent Pole Long (x3); Vestibule Pole (x1); Duralumin Pin Peg 17cm (6.7") x18; Rope with rope tensioner 1.4m (4' 6") x2 2.5m (8' 2.5") x2 Forked Rope 5m (16' 5") x2, Repair Pipe; Carry Bag; Pole Case; Peg Case; Instruction Manual
- Carry Bag size: 73x23x27(h)cm (29" x9" x10.5")
- Weight: 9.8kg (21.1lb) (Poles, Pegs and Ropes included)

Snow Peak USA Inc.

404 NW 23rd Ave., Portland Oregon, 97210, USA
Tel. +1 503-697-3330 @snowpeakusa
www.snowpeak.com

Snow Peak, Inc.

456 Nakanohara, Sanjo-shi Niigata 955-0147 Japan
Tel. +81 256-46-5858 Fax. +81 256-46-5860
www.snowpeak.co.jp

For question or concerns
contact the Snow Peak
Customer Service Department.

Snow Peak USA Inc.
 +1 503-697-3330 (9:00-17:00)
Email: info@snowpeak.com

MADE IN VIETNAM