



ACOUSTICS

E120

INSTALLATION GUIDE

For models QI0120 & QI0122

Contents

Important safety information and warnings.....	3
Introduction	5
Package contents	5
E120 System Schematic	7
Planning E120 positioning and back box locations	8
First fix basic wiring.....	9
First fix for line output	10
Bathroom installation guide	10
Wiring for two pairs of speakers	12
Second fix.....	13
Removing the E120 wall panel	15
Specification	14
Warranty	15

Important safety information and warnings

1 Notices

1.1 FCC Statement (for US Customers)

This equipment has been tested and found to comply with the limits for a Class B digital device, pursuant to Part 15 of the FCC Rules. These limits are designed to provide reasonable protection against harmful interference in a residential installation. This equipment generates uses and can radiate radio frequency energy and, if not installed and used in accordance with the instructions, may cause harmful interference to radio communications. However, there is no guarantee that interference will not occur in a particular installation. If this equipment does cause harmful interference to radio or television reception, which can be determined by turning the equipment off and on, the user is encouraged to try to correct the interference by one or more of the following measures:

- Reorient or relocate the receiving antenna.
- Increase the separation between the equipment and receiver.
- Connect the equipment into an outlet on a circuit different from that to which the receiver is connected.
- Consult the dealer or an experienced radio/TV technician for help.

This device complies with part 15 of the FCC Rules. Operation is subject to the following two conditions:(1) This device may not cause harmful interference, and (2) this device must accept any interference received, including interference that may cause undesired operation.

1.2 FCC Radiation Exposure

This equipment complies with FCC radiation exposure limits set forth for an uncontrolled environment. This equipment should be installed and operated with minimum distance 20cm between the radiator & your body.

CAUTION! Any Changes or modifications not expressly approved by Q Acoustics could void the user's authority to operate the equipment.

1.3 Industry Canada Statement (for Canadian Customers)

This device complies with Industry Canada licence-exempt RSS standard(s).

Operation is subject to the following two conditions:

- (1) This device may not cause interference, and
- (2) This device must accept any interference, including interference that may cause undesired operation of the device.

Le présent appareil est conforme aux CNR d'Industrie Canada applicables aux appareils radio exempts de licence. L'exploitation est autorisée aux deux conditions suivantes:

- (1) l'appareil ne doit pas produire de brouillage, et
- (2) l'utilisateur de l'appareil doit accepter tout brouillage radioélectrique subi, même si le brouillage est susceptible d'en compromettre le fonctionnement.

1.4 Bluetooth

This unit contains a Class 2 *Bluetooth* transmitter working at 2.4GHz.

2 Safety Information and Warnings

2.1 Moisture

- To reduce the risk of fire or electric shock, this apparatus should not be exposed to rain, moisture, dripping or splashing.
- Do not use this apparatus near water.

2.2 Remote Control Batteries

The remote control supplied with this unit contains a battery. To prevent battery leakage which may result in bodily injury, property damage, or damage to the unit:

- Install the battery correctly, + and - as marked on the unit.
- Remove the battery when the unit is not used for a long time.
- Do not expose the battery or remote control to excessive heat, including sunshine.
- CAUTION: Danger of explosion if battery is incorrectly replaced. Replace only with the same or equivalent type.
- WARNING - DO NOT INGEST BATTERY - CHEMICAL BURN HAZARD.
- If the battery is swallowed, it can cause severe internal burns in just 2 hours and can lead to death. Keep new and used batteries away from children. If the battery compartment does not close securely, stop using the product and keep it away from children. If you think batteries might have been swallowed or placed inside any part of the body, seek immediate medical attention

Disposal of Batteries

The battery supplied contains perchlorate material and in many areas batteries may not be disposed of with your household waste. Please ensure you dispose of batteries according to local regulations.

The battery supplied does not contain the heavy metals mercury or cadmium.

2.5 Servicing

Servicing is required when the unit or mains cord has been damaged in any way, liquid has been spilled or objects have fallen into the apparatus, the apparatus has been exposed to rain or moisture, it does not operate normally, or has been dropped.

Refer all servicing to qualified service personnel.

3.0 Symbols used on this product



High Voltage Hazard Symbol

This symbol indicates uninsulated material within your unit may cause an electrical shock. For the safety of everyone in your household, please do not remove the product covering.



Hazard Warning Symbol

The 'exclamation mark' calls attention to features for which you should read this manual closely to prevent operation and maintenance problems. **WARNING:** To reduce the risk of fire or electric shock, this apparatus should not be exposed to rain or moisture and object filled with liquids, such as vases, should not be placed on this apparatus. **CAUTION:** To prevent electric shock, match wide blade of plug to wide slot, fully insert.



Waste Electrical and Electronic Equipment Symbol

This symbol indicates that when the unit is to be discarded, it must be separated from other household-type waste and sent to separate collection facilities for recovery and recycling of electrical and electronic equipment.

Please make sure you are familiar with your local rules on the separate collection of electrical and electronic products.

Introduction

Q Acoustics E120 is an installed DAB, FM, Bluetooth and AUX input Hi-Fi system easily installed into your room. It is particularly suited to kitchens, bathrooms* and bedrooms but could equally be used in any other room in the house.

The following instructions assume that you are competent in general electrical installation skills. You will need to mount a touch panel into a double gang back box and route cables from this box to the speakers and mains. If you are not confident in doing this you should seek professional assistance from a qualified electrician.

It is possible to connect TV sound or another device into the rear auxiliary line input using an additional cable.

*The main E120 wall unit is IP54 rated. It should be located outside zone 2 of the electrical safety zones, if in doubt you are advised to seek assistance from a qualified electrician.

Package contents

1st Fix Package contents:

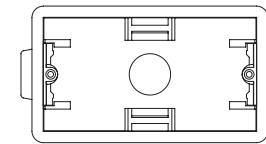

1 x Plastic stud wall installation box

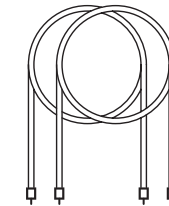

2 x 7m speaker cable

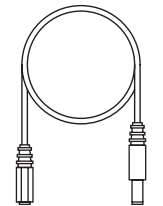

1 x 5m Power supply extension cable

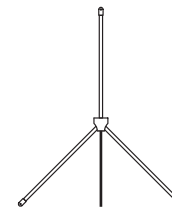

1 x Indoor DAB antenna

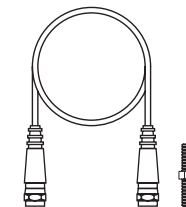

1 x 3m antenna extension cable + adaptor

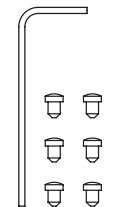

6 x Rubber grommets + 1 x extraction tool

Main unit contents:

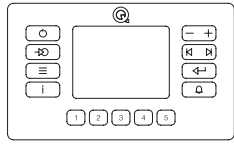

1 x In-wall audio system keypad

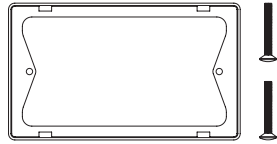

1 x Wall unit mounting frame + 2 x M3.5mm x40mm screws

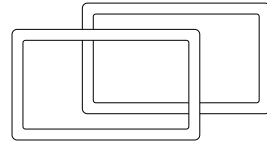

1 x 1.0mm wall gasket + 2.5mm wall gasket

Power supply contents:

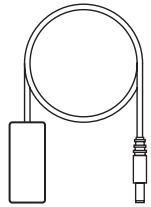

1 x Power supply

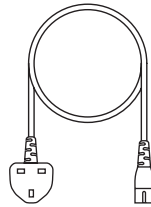

1 x UK power cable

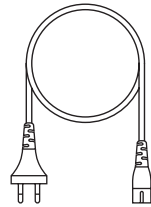

1 x EU power cable

Additional contents:

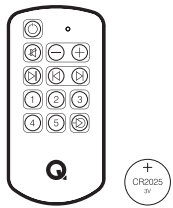

1 x Waterproof remote control + cell battery

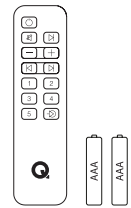

1 x Premium remote control + 2 x AAA batteries

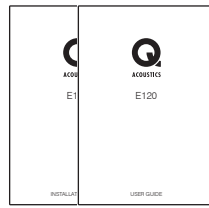

1 x User guide + installation guide

Optional parts (purchased separately or part of a pack):

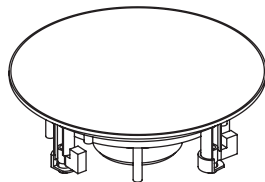

Q Acoustics QI65C in-ceiling speakers

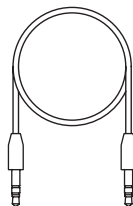

Optical or analogue audio cable

E120 System Schematic

The system is designed to be connected together as shown below:

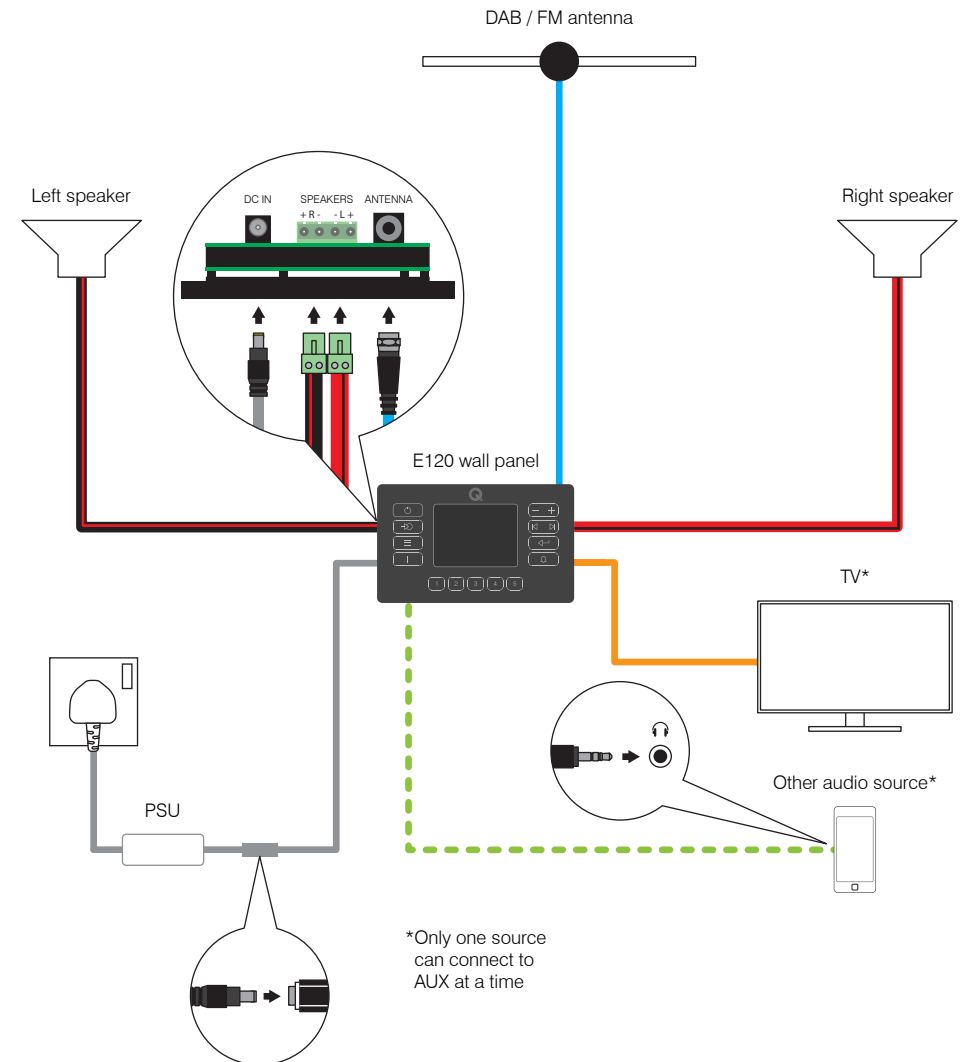

- Key:**
- Power cable
 - Speaker cable (left)
 - Speaker cable (right)
 - 3.5mm jack cable (not supplied)
 - Optical mini TOSLINK (not supplied)
 - Antenna cable

Planning E120 positioning and back box locations

Use the guidelines below to plan the positioning of the back boxes, speakers, and cabling. Dimensions should be checked prior to installation to ensure the layout works correctly with the supplied lengths of cable.

If more than 7m of speaker cable is required then a suitable alternative such as QED 16/2 can be purchased and cut to length.

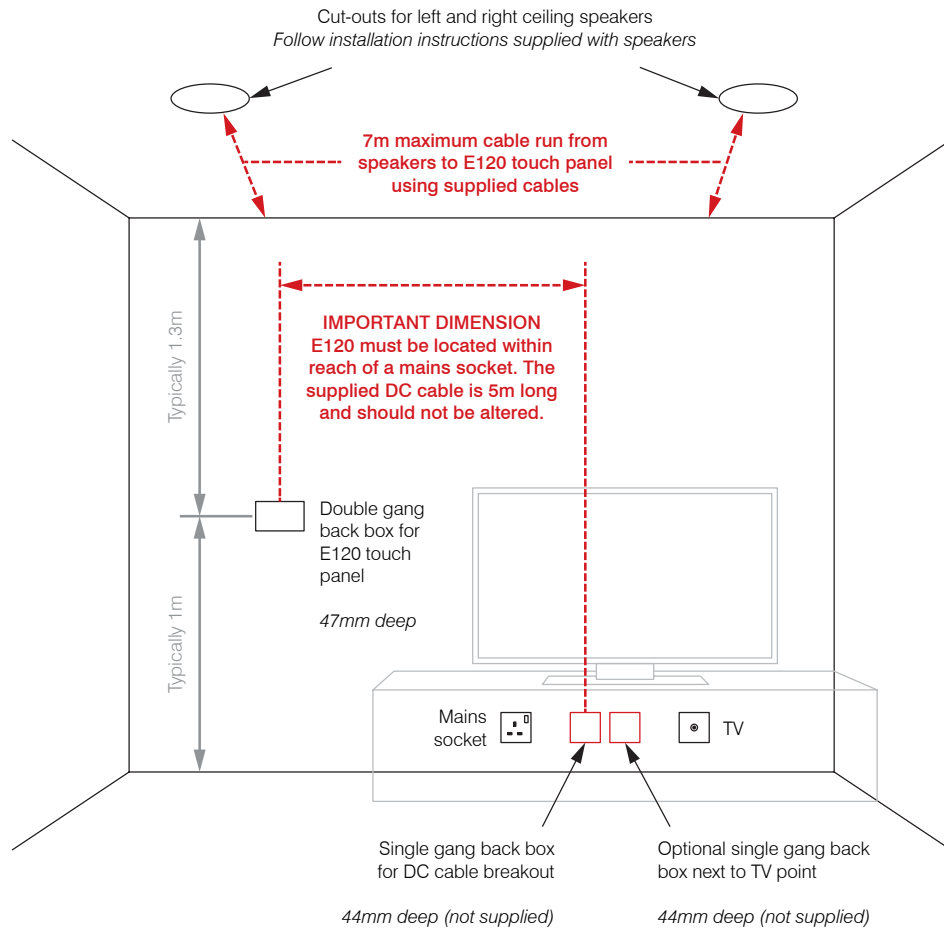

First fix basic wiring

A basic E120 system with auxiliary optical digital input will have the first fix cable requirement as shown below.

Cut holes for required back boxes and speakers. Run speaker and power cables as shown, leaving the length of tails accessible for second fix. Optional line input cable can be run at this point.

Notes:

1. Switched mains socket required next to the DC extension cable for the power supply to plug in.
2. Single gang back box can be used for the optical AUX input cable. The can be terminated using an optical termination plate such as the Nexxia Digital Optical Module Insert.
3. The supplied antenna cable can be attached to a normal quality coax cable which then connects to an external antenna. If an external antenna can not be fitted then place the supplied internal antenna as recommended in the Antenna alignment section.

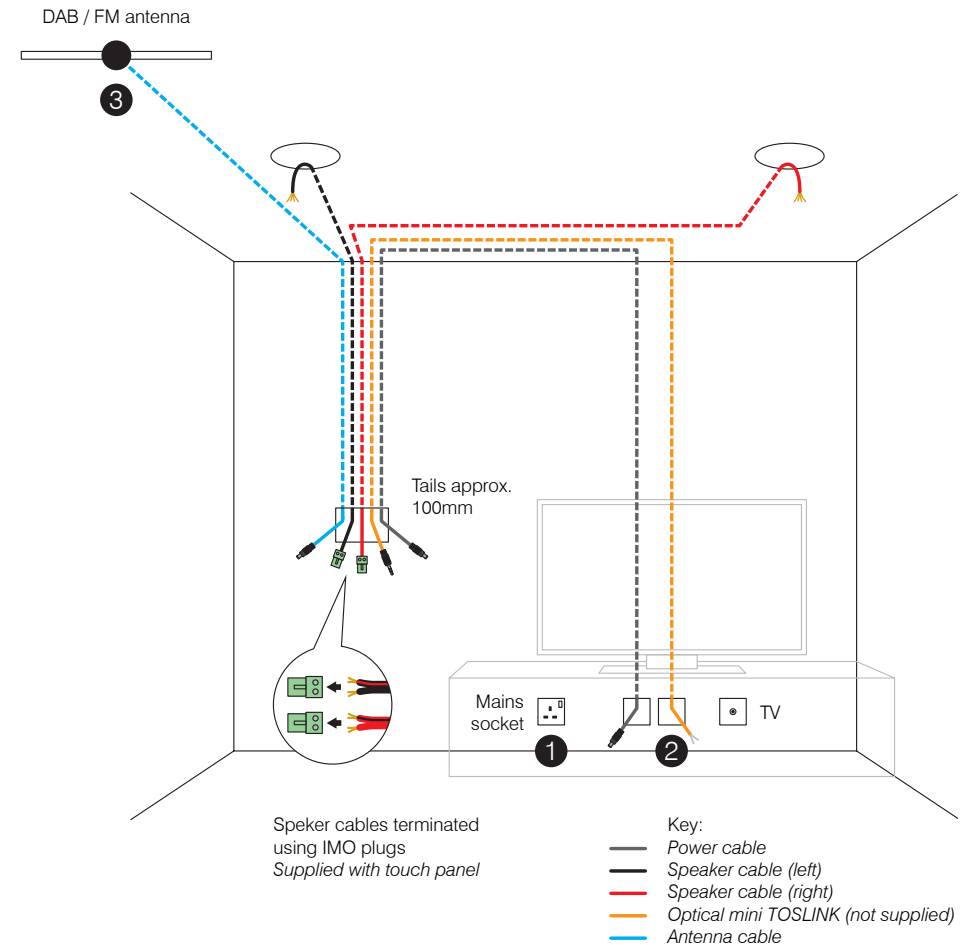

First fix for line output

The analogue 3.5mm stereo line output can be used to connect an external amplifier or sub-woofer.

Note that analogue audio signals are prone to picking up interference and this line output should be limited to 10m.

Bathroom installation guide

E120 can be fitted into a bathroom environment, which is different to most other rooms in the home. The nature of this wet environment is recognised by the respective standards authorities who test products in terms of their suitability to be installed in such areas.

E120 complies with IP54 (Ingress protection).

E120 system is defined as an 'Extra Low Voltage Installation', but the wiring needs to be installed in accordance with 'Part P' of the Design and Installation of Electrical Installations. If in doubt, you are advised to seek assistance from a qualified electrician.

Please refer to the diagram below, E120 should be installed in either zone 2 (light blue) or zone 3 (white).

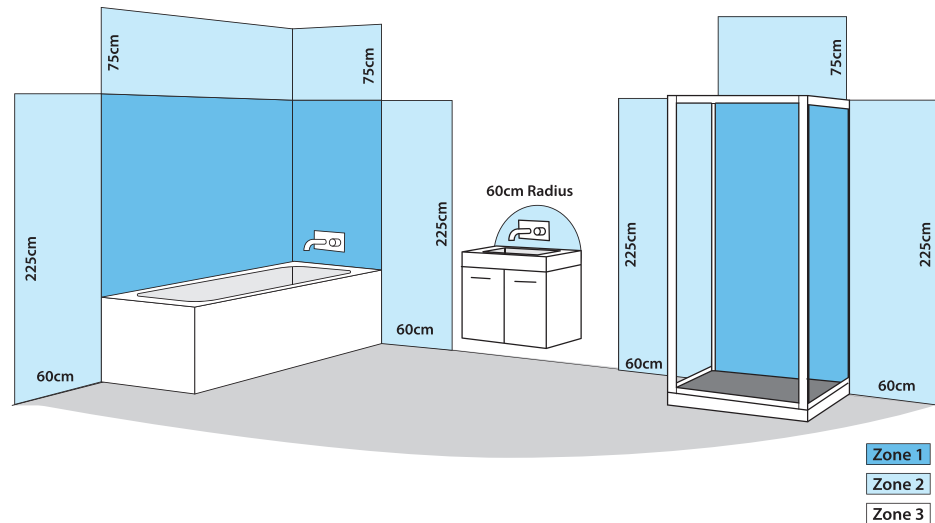

Reaching IP54:

E120 is supplied with two rubber gaskets of different thicknesses which should be stuck to the wall side of the metal frame prior to screwing the frame to the back box. This will create a seal between the frame and the wall and ensure better water protection. If the wall is flat then the thinner 1mm gasket can be used, for uneven walls (such as between tile joins) then the thicker 2.5mm gasket can be used.

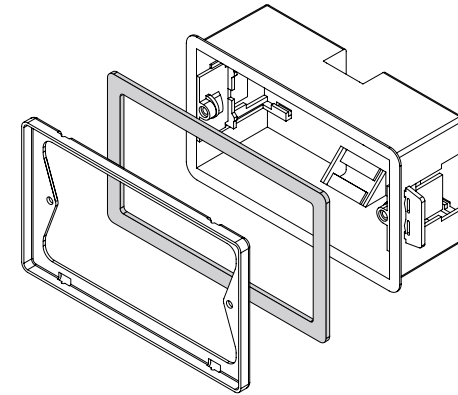

Wiring for two pairs of speakers

For larger open plan areas, two pairs of speakers can be used to achieve an even distribution of sound. A speaker wire (purchased separately) should be fitted between the first speaker and the second, for both left and right as shown in the diagram. The speakers should be connected in series where the negative (black) connector of the first speaker is connected to the positive (red) connector of the second. The negative (black) connector of the second speaker is then connected to the negative (black) cable to the E120 unit using a connector block, as shown in the diagram. This series method of connecting two speakers will ensure a high quality and reliable sound performance of the speakers.

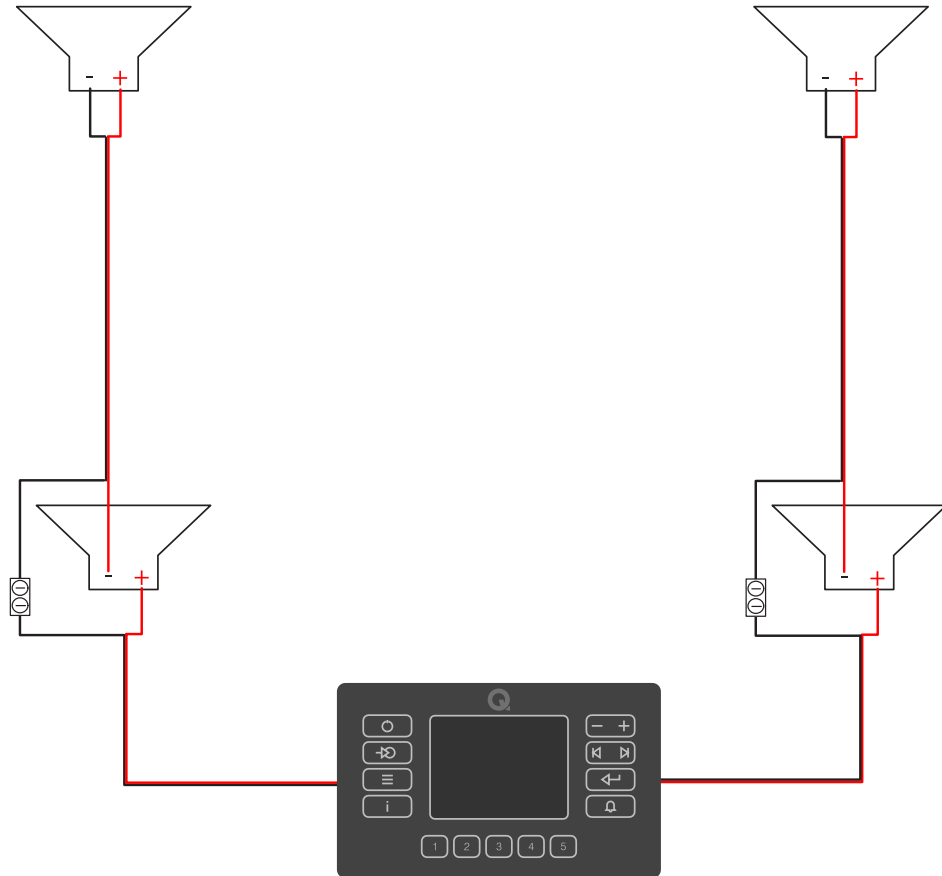

Second fix

Antenna alignment:

An external DAB antenna is recommended, if that is not possible then E120 is supplied with a flexible indoor antenna which should be aligned vertically as shown below.

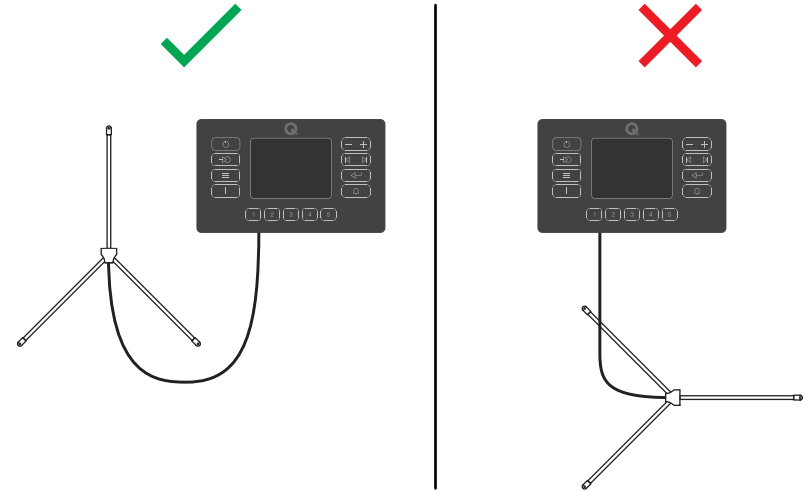

Configurable Switches:

There are two small switches mounted on the lower PCB that adjust the audio mode outputs. After making a switch position change you will need to power down the E120.

SWITCH 1 OFF – Line output is variable, adjusts with amplifier volume.

SWITCH 1 ON – Line output is fixed at 100%

SWITCH 2 OFF – Amplifier speaker outputs are in stereo mode with separate left and right channels.

SWITCH 2 ON – Amplifier speaker outputs are in mono mode with both left and right channels combined on both speaker outputs.

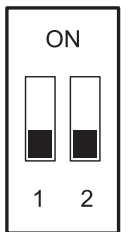

Connect cable tails to wall panel, speaker and power supply. Fix items in place using instructions supplied with the speakers to ensure correct speaker installation.

Notes:

1. Blanking plate required to cover break out box, requires a single hole to exit DC extension cable.
2. Optional AUX input / TV sound requires a 25 x 50mm TOSLINK optical socket module (if using optical cable), such as the 'Nexxia Digital Optical Module Insert' which is a 25x50mm slot in module.

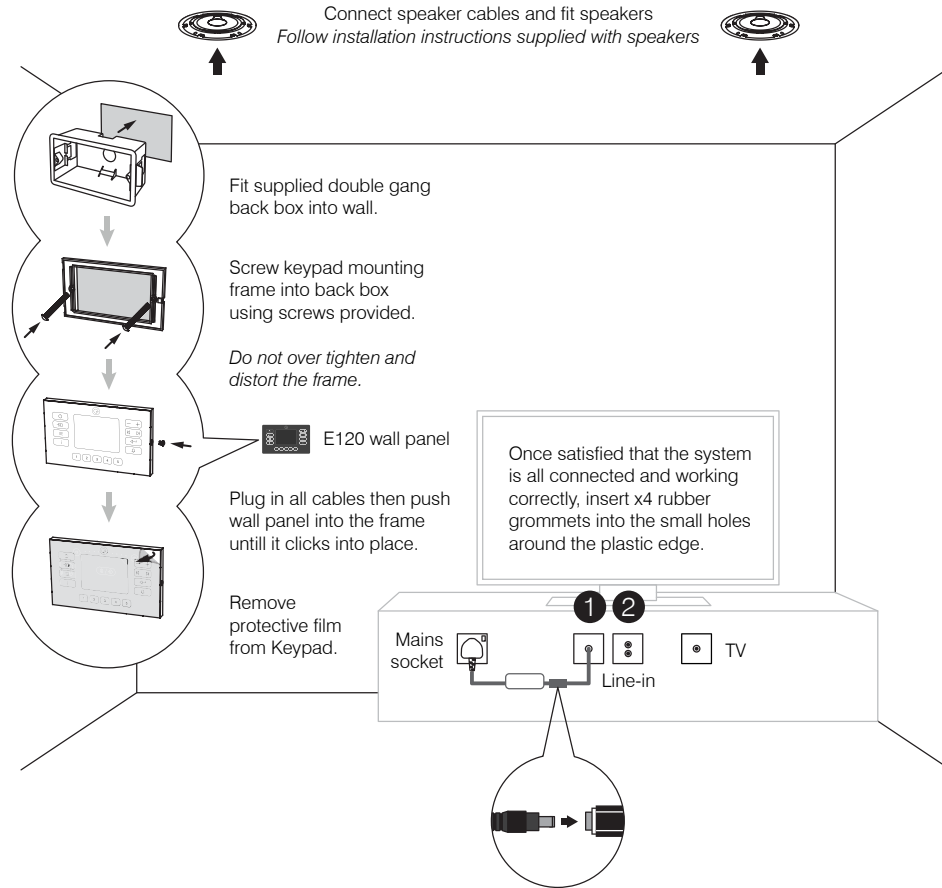

Removing the E120 wall panel

To remove the wall panel once it has been 'clicked' into the mounting frame follow these steps:

1. Remove the small rubber grommets from each of the small holes around the outer frame, keep safe.
2. Use the small removal tool provided, or a similar tool 1.4mm diameter to insert into the hole, add a little pressure into the frame whilst gently pulling the corresponding corner of the wall unit away from the wall.
3. When the unit comes away slightly, repeat the process for the next hole until all four have been released.
4. The E120 wall unit can now be removed away from the mounting frame and off the wall.

Specification

Audio Sources	DAB / DAB+ / FM with RDS	F-connector		
	Bluetooth	Wireless	BT 5.0 A2DP	
	AUX:			
	- Analogue	3.5mm stereo	Sensitivity: 350mV Max level: 1.5V Impedence: 10k ohm	
	- Optical	mini TOSLINK	Resolution: 16bit 48kHz	
Audio Outputs	Speaker outputs	Left & Right	Stereo or dual mono	
	Analogue line	3.5mm stereo	Modes: Fixed or variable Max level: 670mV	
Amplifier	Class D	Continuous power	2 x 25W @ 6ohm	
		THD	0.07% @ 1W 0.2% @ rated power	
		SNR	> 75dB @ Rated power	
		Frequency response	20Hz - 20kHz +/- 1dB	
Ratings		E120 wall panel	IP54	
		Splash proof remote	IP54	
Control	Touch sensitive buttons	x 15		
	IR remote control	x 13		
	BT AVRCP	v1.6 (play, pause, skip, track, artist, album name)		
	Menu languages	English, German, Dutch, French, Danish, Spanish Italian, Norwegian, Polish, Finnish		
	Alarms	x2 once, daily, weekdays, weekends		
General	Power supply	Input	100 - 240V AC 50/60 Hz	
		Output	22V DC 1.5amps	
		Dimensions (HxWxD)	30mm x 50mm x 115mm	
	Power consumption	Typical	10W	
		Standby	< 1W	
		Deep standby	< 0.5W	
	Wall panel	Net weight	0.251kg	
		Dimensions (HxWxD)	91mm x 151mm x 33mm	
		Operating ambient temperature	Max. 40 °C	
Cables	Speaker cable	Gauge	19 AWG	
		Lengths	2 x 7m	
	DC extension	Gauge	16 AWG	
		Lengths	5m	
		Connectors	5.5mm x 2.5mm DC male 5.5mm x 2.5mm DC female	

Warranty

Q Acoustics Media products are warranted free of defects in materials and workmanship for a period of 1 year from the date of purchase. During the warranty period Q Acoustics will, at its option, repair or replace any product found to be faulty after inspection by the company or its appointed distributor or agent.

Misuse and fair wear and tear are not covered by warranty.

Goods for repair should in the first instance be returned to the supplying dealer. If this is not possible contact Q Acoustics or their appointed distributor for your area to determine the correct warranty procedure. If possible the original packaging should be used to return the product as damage sustained during transit to the repair centre is not covered by the warranty. The warranty does not in any way affect your legal rights.

Warranty can be extended to 2 years by registering your product at www.qacoustics.co.uk/register. For service information in other countries visit: www.qacoustics.co.uk

Q Acoustics
Armour Home Electronics Limited
Woodside 2, Dunmow Road
Bishops Stortford, Herts
CM23 5RG

Our policy is one of continuous product improvement.
We reserve the right to change the designs and specifications without notice.
This document contains information that is subject to change without notice.



The Bluetooth® word mark and logo are registered trademarks owned by Bluetooth SIG, Inc. and use of such marks by Armour Home Electronics Limited is under license. Other trademarks and trade names are those of their respective owners.



ACOUSTICS

QACOUSTICS.CO.UK